

SKY 72

İŞIKLIK SİSTEM
SKYLIGHT SYSTEM



Köşe takoz profili
Corner cleat profile

Weight : 2,327 kg/m	
W55.450-7	8,4mm
W55.450-11	56,5mm
W55.450-12	51,7mm
W55.450-13	38mm



Köşe onbaşı
Corner cleat

LS55617 LS55618



Yatay sayfa
Page horizontal

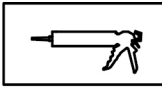

Silikon
Silicone



Dikkat
Attention

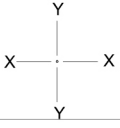

SKY72 IŞIKLIK SİSTEM / SKYLIGHT SYSTEM
ÜRÜN TEKNİK ÖZELLİKLERİ / PRODUCTS TECHNICAL FEATURES

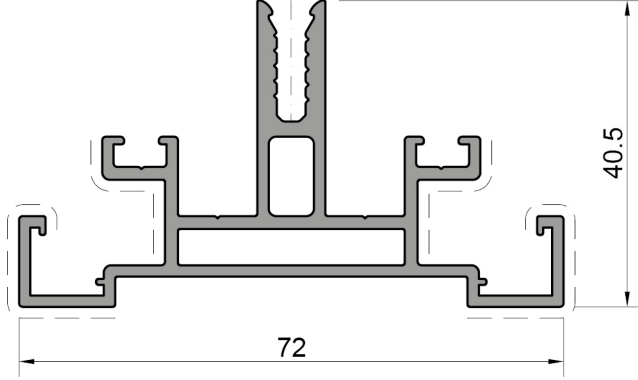

düşey profil <i>mullion profile</i>
SKY.72.101
Weight : 1,180 kg/m

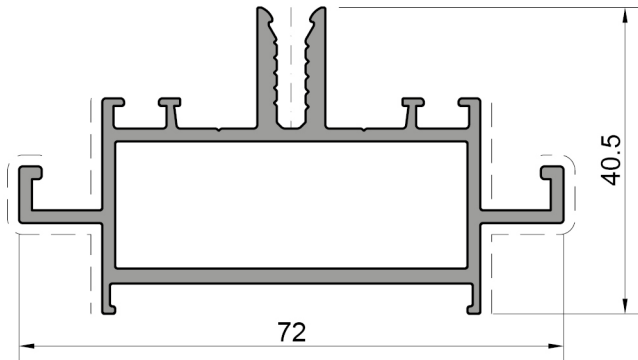

yatay profil <i>transom profile</i>
SKY.72.102
Weight : 1,121 kg/m

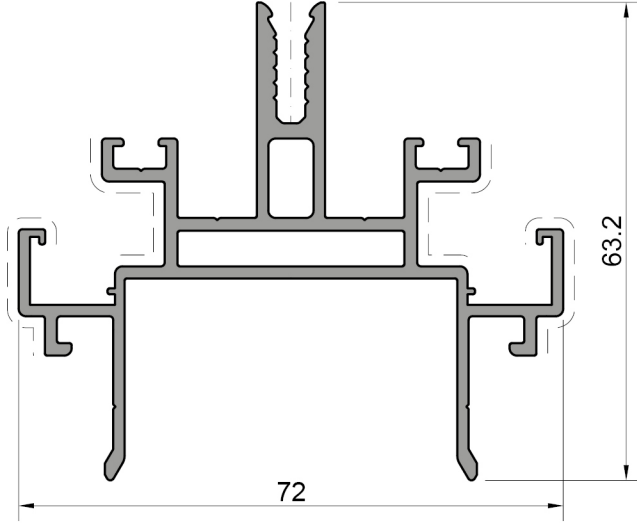
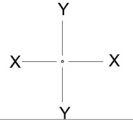

düşey profil <i>mullion profile</i>
SKY.72.103
Weight : 1,180 kg/m

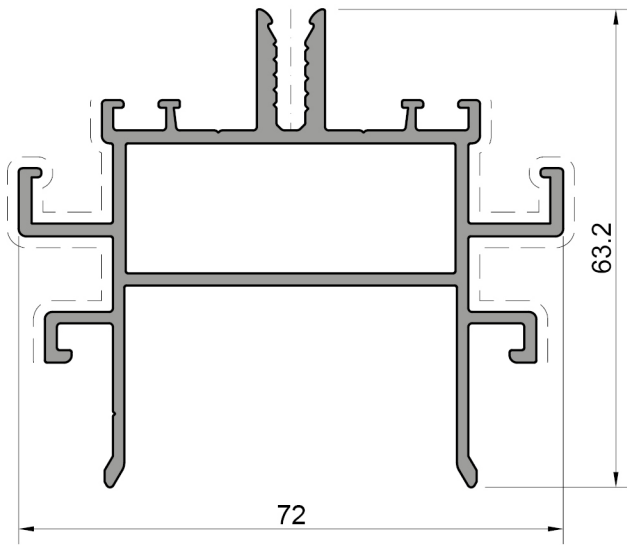

yatay profil <i>transom profile</i>
SKY.72.104
Weight : 1,121 kg/m

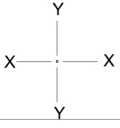

SKY72 IŞIKLIK SİSTEM / SKYLIGHT SYSTEM
ÜRÜN TEKNİK ÖZELLİKLERİ / PRODUCTS TECHNICAL FEATURES

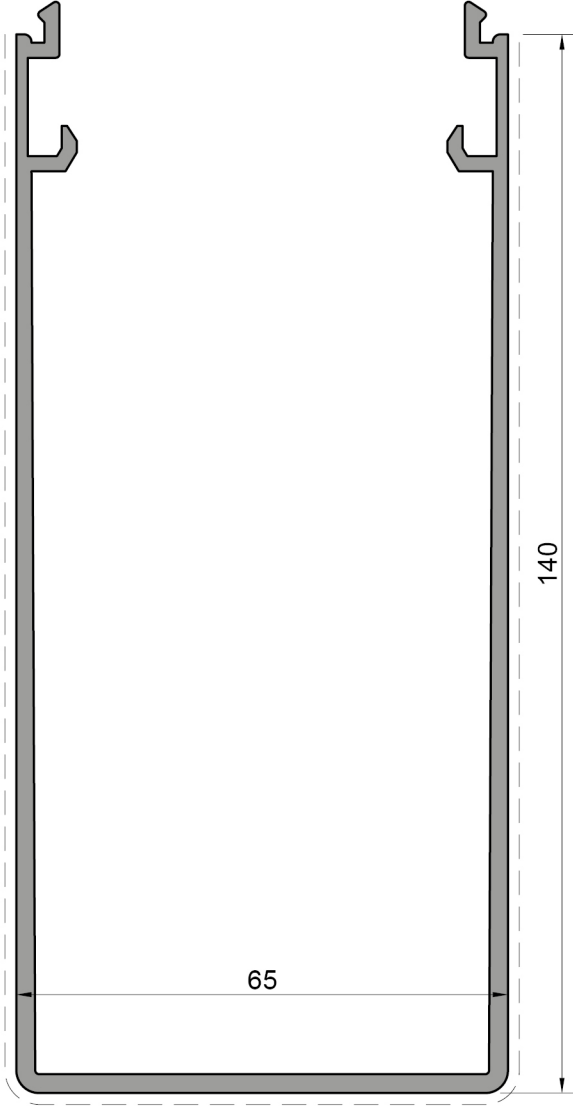

düşey profil <i>mullion profile</i>
SKY.72.401
Weight : 2,230 kg/m

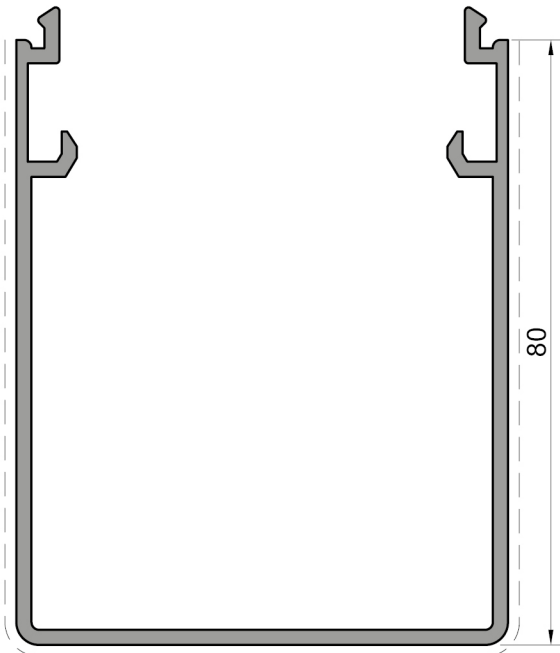

yatay profil <i>transom profile</i>
SKY.72.402
Weight : 1,339 kg/m

Profil değerleri teoriktir. Ağırlık olarak teslimde yapılan tartım geçerlidir. Profil imalatları TS EN 12020-02 ve TS EN 755-9 toleransı, Moment değerleri EN 14024'e göre hesaplanmıştır.
Profile values are theoretical pre-shipment weight will be valid. The tolerances of Profile manufacturing are calculated according to EN 12020-2 and TS EN 755-9; moment values are calculated according to EN 14024.

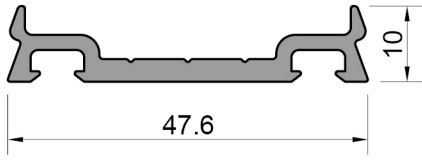
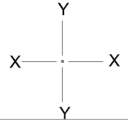

baskı profili <i>pressure profile</i>
FC.50.401
Weight : 0,443 kg/m

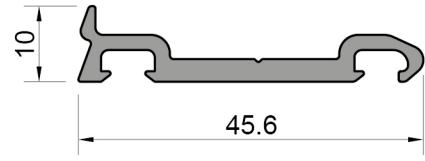

baskı profili <i>pressure profile</i>
SKY.72.401
Weight : 0,400 kg/m

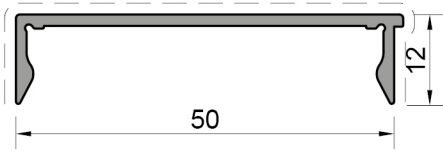

kapak profili <i>cover profile</i>
FC.50.410
Weight : 0,295 kg/m

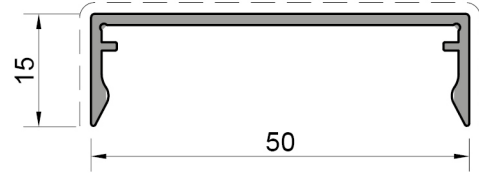

kapak profili <i>cover profile</i>
FC.50.411
Weight : 0,325 kg/m

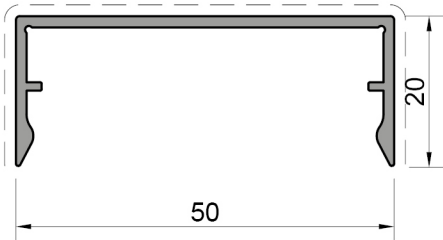

kapak profili <i>cover profile</i>
FC.50.412
Weight : 0,360 kg/m

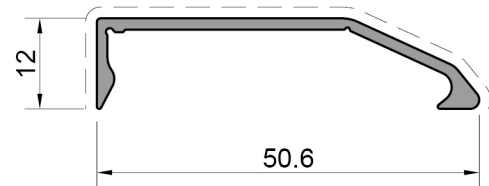

kapak profili <i>cover profile</i>
SKY.72.402
Weight : 0,284 kg/m

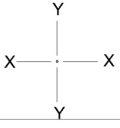

SKY72 IŞIKLIK SİSTEM / SKYLIGHT SYSTEM

ÜRÜN TEKNİK ÖZELLİKLERİ / PRODUCTS TECHNICAL FEATURES

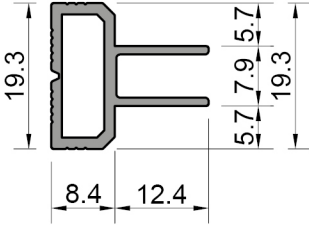

çift cam bonding pr.
double glass bonding pr.

FC.50.310

Weight : 0,260 kg/m

sadece 20 mikron mat siyah eloksal kullanılır
only used 20 micron mat black anodized

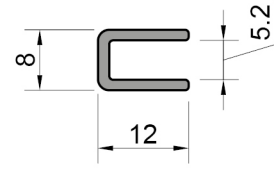

çift cam bonding pr.
double glass bonding pr.

FC.50.311

Weight : 0,109 kg/m

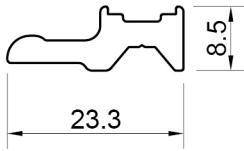

bağlantı profili
connection profile

FC.50.540

Weight : 0,298 kg/m

FS.50.540-1 50mm

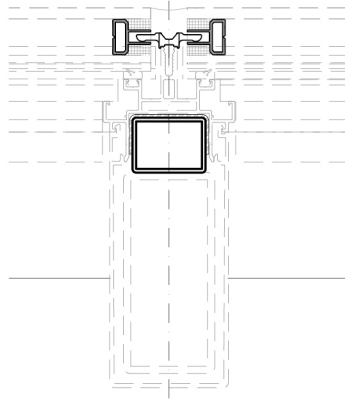

bağlantı profili
connection profile

FC.50.541

Weight : 0,433 kg/m

FS.50.541-1 50mm

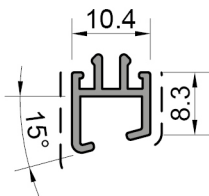

köşe adaptör profili
corner adapter profile

FC.50.510

Weight : 0,113 kg/m

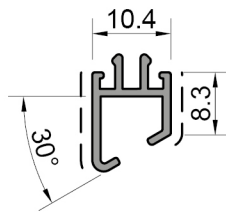

köşe adaptör profili
corner adapter profile

FC.50.511

Weight : 0,124 kg/m

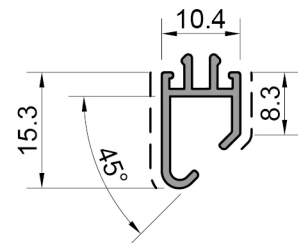

köşe adaptör profili
corner adapter profile

FC.50.512

Weight : 0,135 kg/m

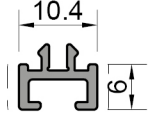
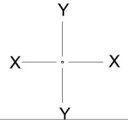

tek cam adaptör profili <i>single glazing adapter profile</i>
FC.50.515
Weight: 0,094 kg/m

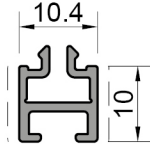

tek cam adaptör profili <i>single glazing adapter profile</i>
FC.50.516
Weight: 0,129 kg/m

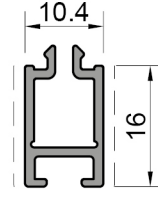

tek cam adaptör profili <i>single glazing adapter profile</i>
FC.50.517
Weight: 0,173 kg/m

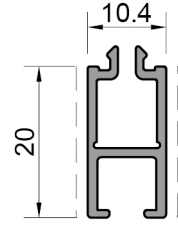

tek cam adaptör profili <i>single glazing adapter profile</i>
FC.50.518
Weight: 0,203 kg/m

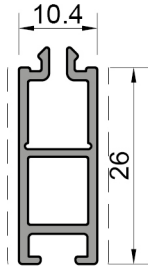

tek cam adaptör profili <i>single glazing adapter profile</i>
FC.50.519
Weight : 0,259 kg/m

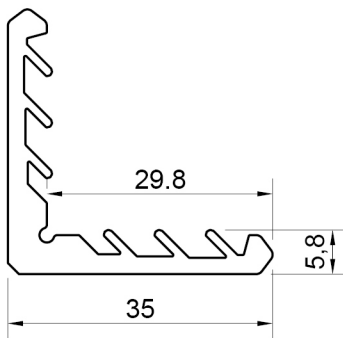
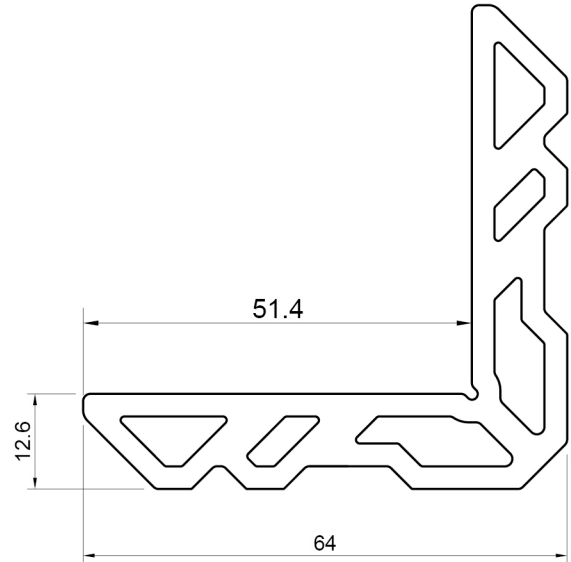

köşe takoz profili <i>corner cleat profile</i>
FC.50.545
Weight : 0,650 kg/m

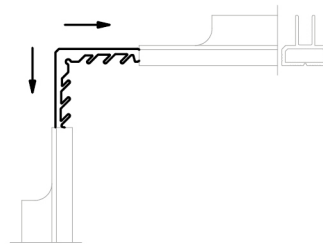

köşe takoz profili <i>corner cleat profile</i>	
W55.450	
Weight : 2,327 kg/m	
W55.450-7	8,4mm
W55.450-11	56,5mm
W55.450-12	51,7mm
W55.450-13	38mm

SKY 72 IŞIKLIK SİSTEM / SKYLIGHT SYSTEM
ÜRÜN TEKNİK ÖZELLİKLERİ / PRODUCTS TECHNICAL FEATURES

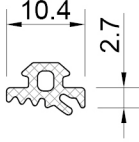
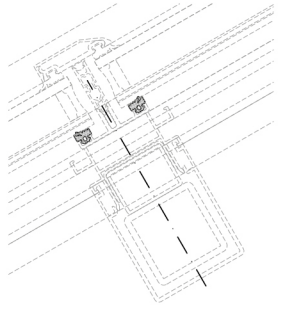
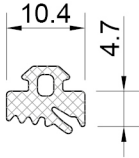
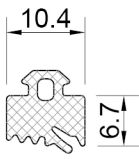
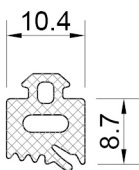
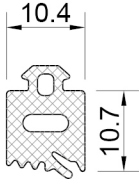
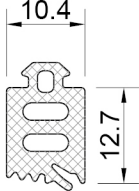
Kod Code	Şekil Drawing	Tanım Description	Teorik Ağırlık Theoretical Weight gr / m	Paket Ağırlığı Package Weight Kg / Package	Paket Metrajı In one Package Metre / Package	Kullanım Yeri Application
FC.50.601		taşıyıcı ve kaset iç fitili mullion-transom end panel gasket inside	42 gr/m	15 kg	350 m	
FC.50.602		taşıyıcı ve kaset iç fitili mullion-transom end panel gasket inside	66 gr/m	15 kg	223 m	
FC.50.603		taşıyıcı ve kaset iç fitili mullion-transom end panel gasket inside	97 gr/m	15 kg	152 m	
FC.50.604		taşıyıcı ve kaset iç fitili mullion-transom end panel gasket inside	104 gr/m	15 kg	142 m	
FC.50.605		taşıyıcı ve kaset iç fitili mullion-transom end panel gasket inside	136 gr/m	15 kg	108 m	
FC.50.606		taşıyıcı ve kaset iç fitili mullion-transom end panel gasket inside	146 gr/m	15 kg	101 m	

Profil değerleri teoriktir. Ağırlık olarak teslimde yapılan tartım geçerlidir. Profil imalatları TS EN 12020-02 ve TS EN 755-9 toleransı, Moment değerleri EN 14024'e göre hesaplanmıştır.
 Profile values are theoretical pre-shipment weight will be valid. The tolerances of Profile manufacturing are calculated according to EN 12020-2 and TS EN 755-9; moment values are calculated according to EN 14024.

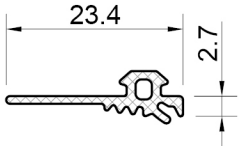
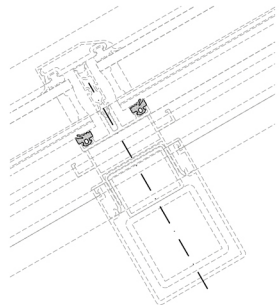
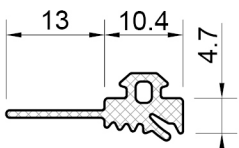
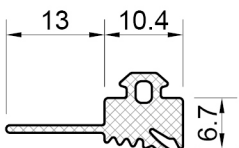
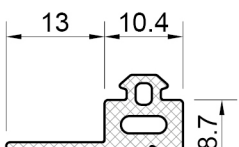
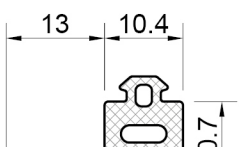
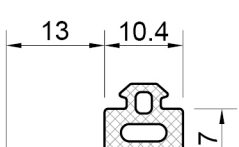
Kod Code	Şekil Drawing	Tanım Description	Teorik Ağırlık Theoretical Weight gr / m	Paket Ağırlığı Package Weight Kg / Package	Paket Metrajı In one Package Metre / Package	Kullanım Yeri Application
FC.50.610		taşıyıcı ve kaset iç fitili <i>mullion-transom end panel gasket inside</i>	61 gr/m	15 kg	242 m	
FC.50.611		taşıyıcı ve kaset iç fitili <i>mullion-transom end panel gasket inside</i>	86 gr/m	15 kg	172 m	
FC.50.612		taşıyıcı ve kaset iç fitili <i>mullion-transom end panel gasket inside</i>	115 gr/m	15 kg	128 m	
FC.50.613		taşıyıcı ve kaset iç fitili <i>mullion-transom end panel gasket inside</i>	126 gr/m	15 kg	117 m	
FC.50.614		taşıyıcı ve kaset iç fitili <i>mullion-transom end panel gasket inside</i>	153 gr/m	15 kg	96 m	
FC.50.615		taşıyıcı ve kaset iç fitili <i>mullion-transom end panel gasket inside</i>	164 gr/m	15 kg	90 m	

Profil değerleri teoriktir. Ağırlık olarak teslimde yapılan tartım geçerlidir. Profil imatları TS EN 12020-02 ve TS EN 755-9 toleransı, Moment değerleri EN 14024'e göre hesaplanmıştır.

Profile values are theoretical pre-shipment weight will be valid. The tolerances of Profile manufacturing are calculated according to EN 12020-2 and TS EN 755-9; moment values are calculated according to EN 14024.

SKY72 IŞIKLIK SİSTEM / SKYLIGHT SYSTEM
ÜRÜN TEKNİK ÖZELLİKLERİ / PRODUCTS TECHNICAL FEATURES

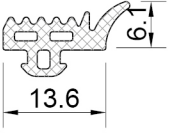
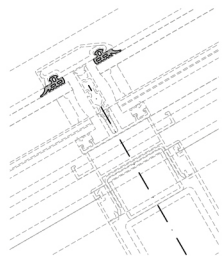
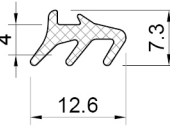
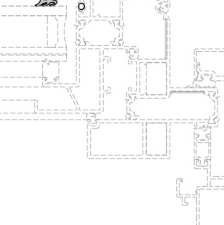
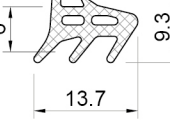
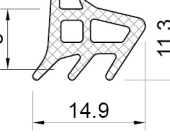
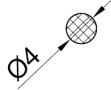
Kod Code	Şekil Drawing	Tanım Description	Teorik Ağırlık Theoretical Weight gr / m	Paket Ağırlığı Package Weight Kg / Package	Paket Metrajı In one Package Metre / Package	Kullanım Yeri Application
FC.50.620		baskı profil fitili Glazing gasket	85 gr/m	15 kg	173 m	
LS55502		epdm cam iç fitil glazing gasket inside	50 gr/m	15 kg	300 m	
LS55503		epdm cam iç fitil glazing gasket inside	70 gr/m	15 kg	210 m	
LS55504		epdm cam iç fitil glazing gasket inside	86 gr/m	15 kg	171 m	
W55.511		epdm fitil epdm gasket	16 gr/m	10 kg	609 m	

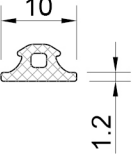
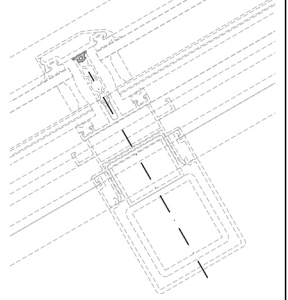
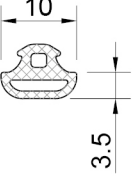
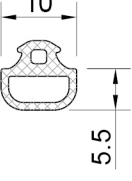
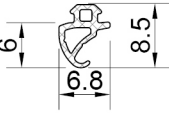
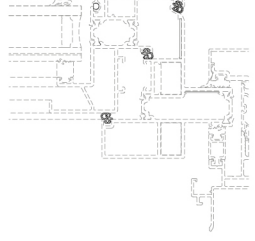
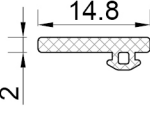
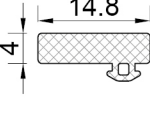
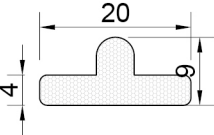
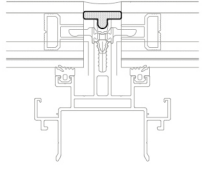

Profil değerleri teoriktir. Ağırlık olarak teslimde yapılan tartım geçerlidir. Profil imalatları TS EN 12020-02 ve TS EN 755-9 toleransı, Moment değerleri EN 14024'e göre hesaplanmıştır.
 Profile values are theoretical pre-shipment weight will be valid. The tolerances of Profile manufacturing are calculated according to EN 12020-2 and TS EN 755-9; moment values are calculated according to EN 14024.

Kod Code	Şekil Drawing	Tanım Description	Teorik Ağırlık Theoretical Weight gr / m	Paket Ağırlığı Package Weight Kg / Package	Paket Metrajı In one Package Metre / Package	Kullanım Yeri Application
FC.50.630		taşıyıcı ön fitili Mullion-transom gasket front	36 gr/m	15 kg	409 m	
FC.50.631		taşıyıcı ön fitili Mullion-transom gasket front	49 gr/m	15 kg	301 m	
FC.50.632		taşıyıcı ön fitili Mullion-transom gasket front	54 gr/m	15 kg	273 m	
W55.501		epdm cam iç fitil glazing gasket inside	25 gr/m	15 kg	590 m	
W55.512		kaset iç fitil frame gasket inside	47 gr/m	15 kg	313 m	
W55.513		kaset iç fitil frame gasket inside	88 gr/m	15 kg	168 m	
FC.50.633		polietilen dolgu	--	--	--	

Profil değerleri teoriktir. Ağırlık olarak teslimde yapılan tartım geçerlidir. Profil imalatları TS EN 12020-02 ve TS EN 755-9 toleransı, Moment değerleri EN 14024'e göre hesaplanmıştır.

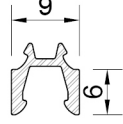
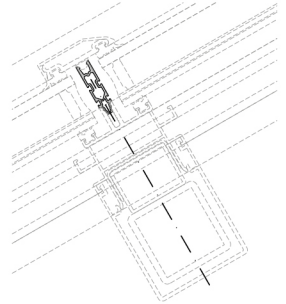
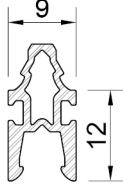
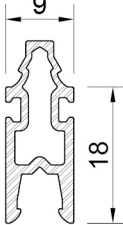
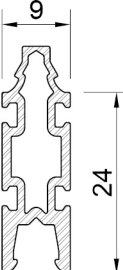
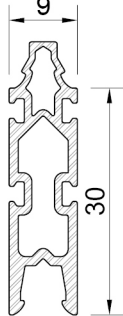
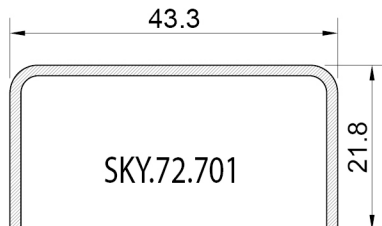
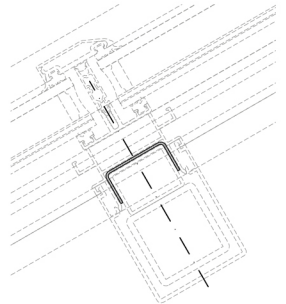
Profile values are theoretical pre-shipment weight will be valid. The tolerances of Profile manufacturing are calculated according to EN 12020-2 and TS EN 755-9; moment values are calculated according to EN 14024.

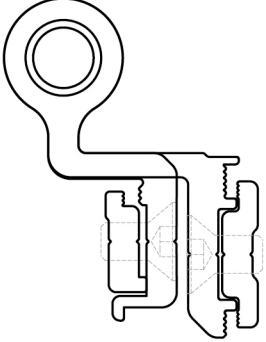
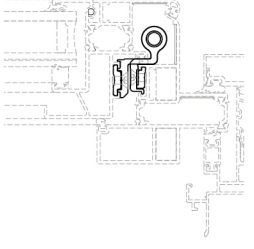
Kod Code	Şekil Drawing	Tanım Description	Paket Metraji In one Package Metre / Package	Kullanım Yeri Application
FC.50.701		taşıyıcı ön izolasyon (pvc) <i>mullion or transom front insulation (pvc)</i>	6.0 m	
FC.50.702		taşıyıcı ön izolasyon (pvc) <i>mullion or transom front insulation (pvc)</i>	6.0 m	
FC.50.703		taşıyıcı ön izolasyon (pvc) <i>mullion or transom front insulation (pvc)</i>	6.0 m	
FC.50.704		taşıyıcı ön izolasyon (pvc) <i>mullion or transom front insulation (pvc)</i>	6.0 m	
FC.50.705		taşıyıcı ön izolasyon (pvc) <i>mullion or transom front insulation (pvc)</i>	6.0 m	
	 SKY.72.701	çelik üzeri izolasyon (pvc) <i>steel insulation (pvc)</i>		

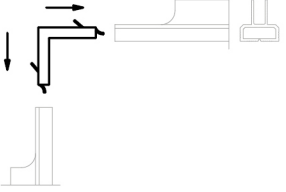
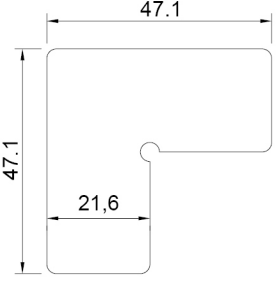
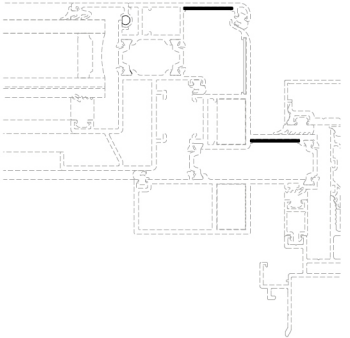
Kod Code	Şekil Drawing	Tanım Description	Paket Metrajı In one Package Metre / Package	Kullanım Yeri Application
W55.770-1	 <p>naturel eloksallı (mat anodized)</p>		50 pcs/pk	
FC.50.770		profil köşe bağlantı corner connect profile	40 pcs/pk	
LS55617		köşe onbaşı corner cleat	200 pcs/pk	

SKY72 IŞIKLIK SİSTEM / SKYLIGHT SYSTEM

YATAY DETAY / HORIZONTAL DETAIL

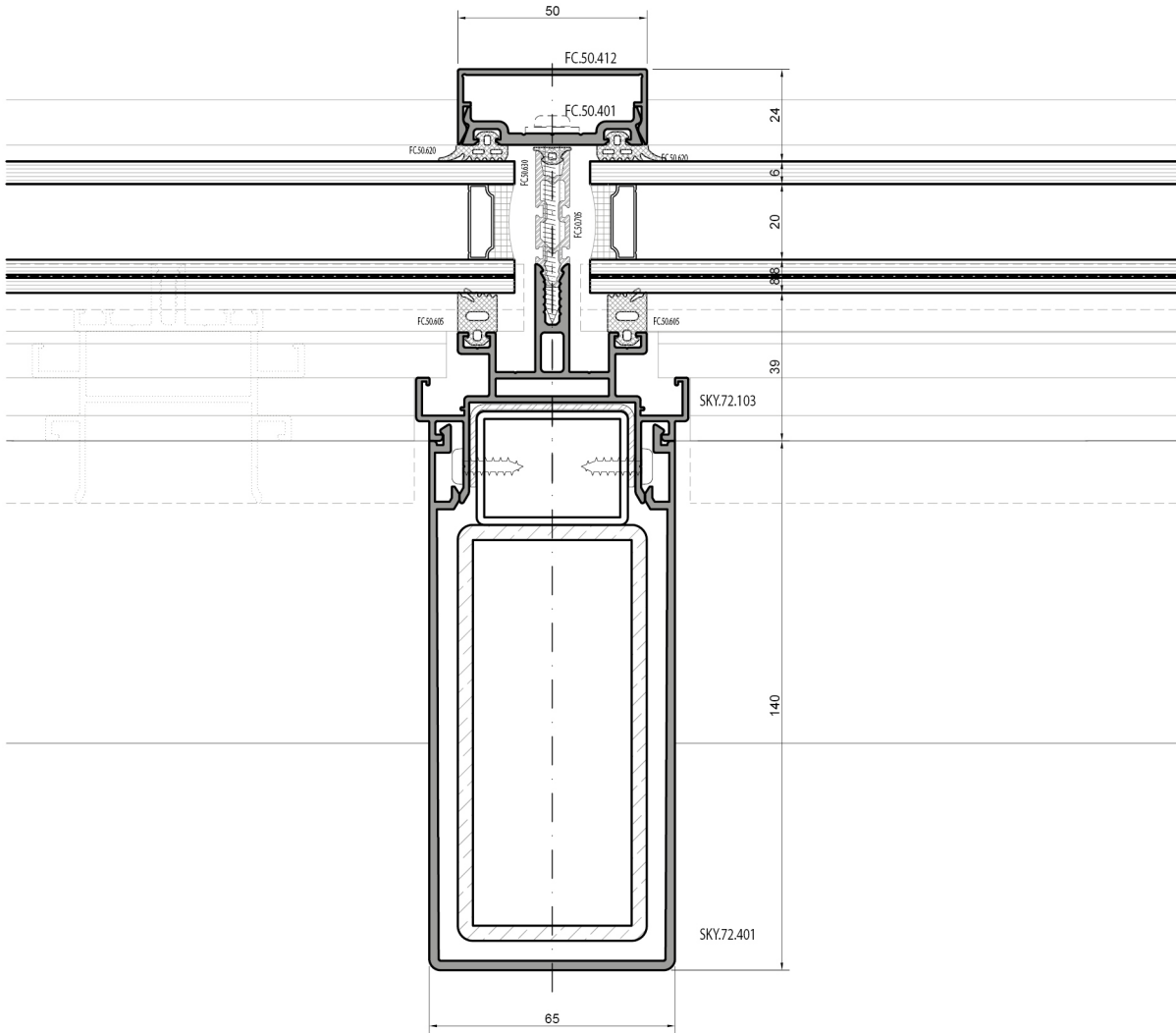
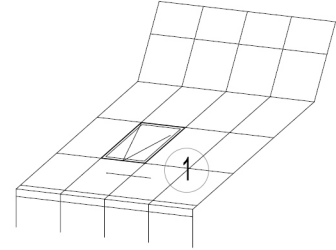

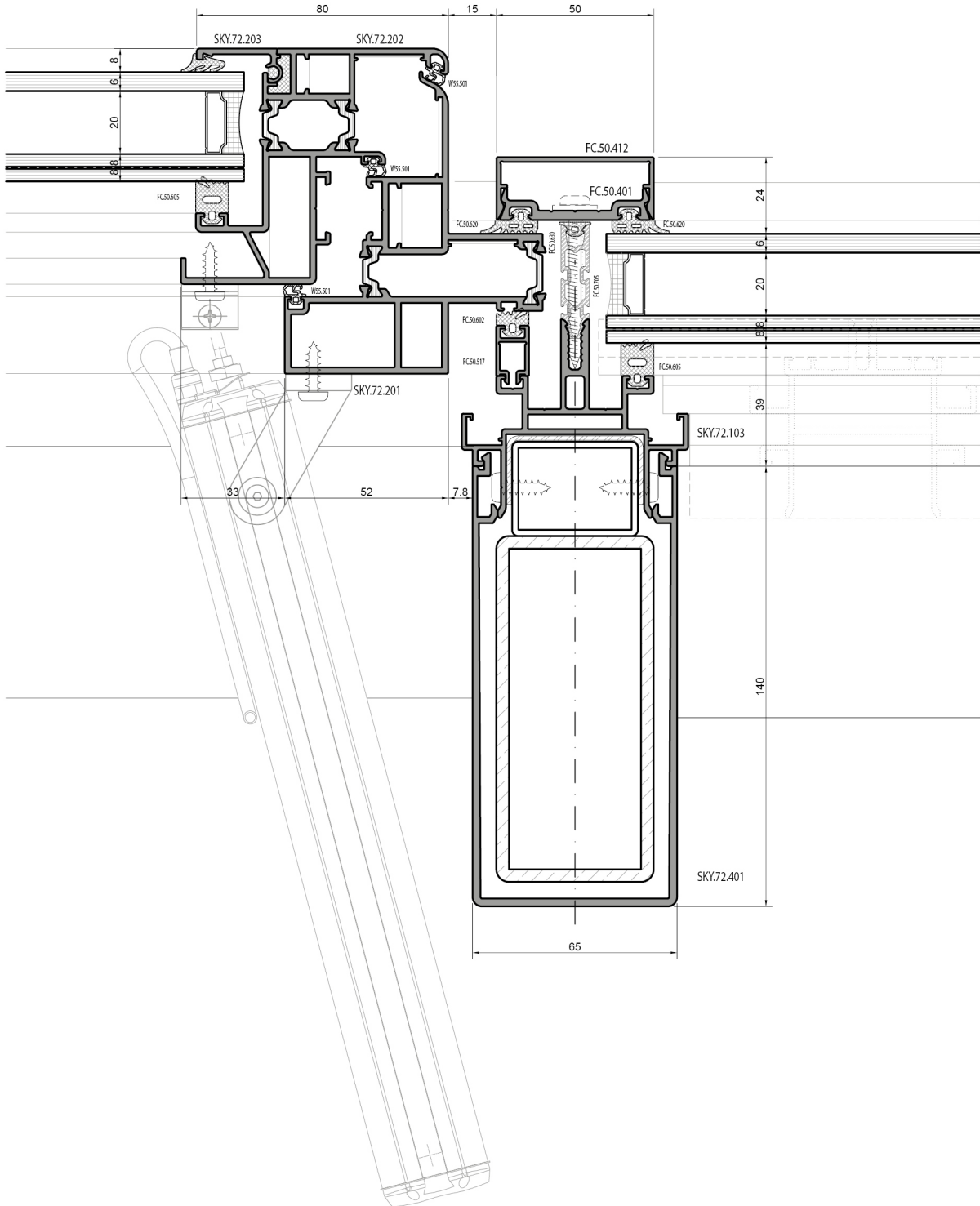
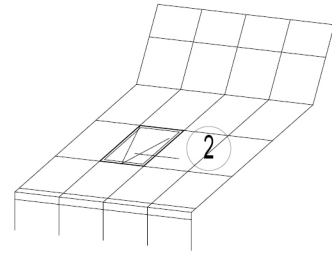

SKY72 IŞIKLIK SİSTEM / SKYLIGHT SYSTEM

DÜŞEY DETAY / VERTICAL DETAIL

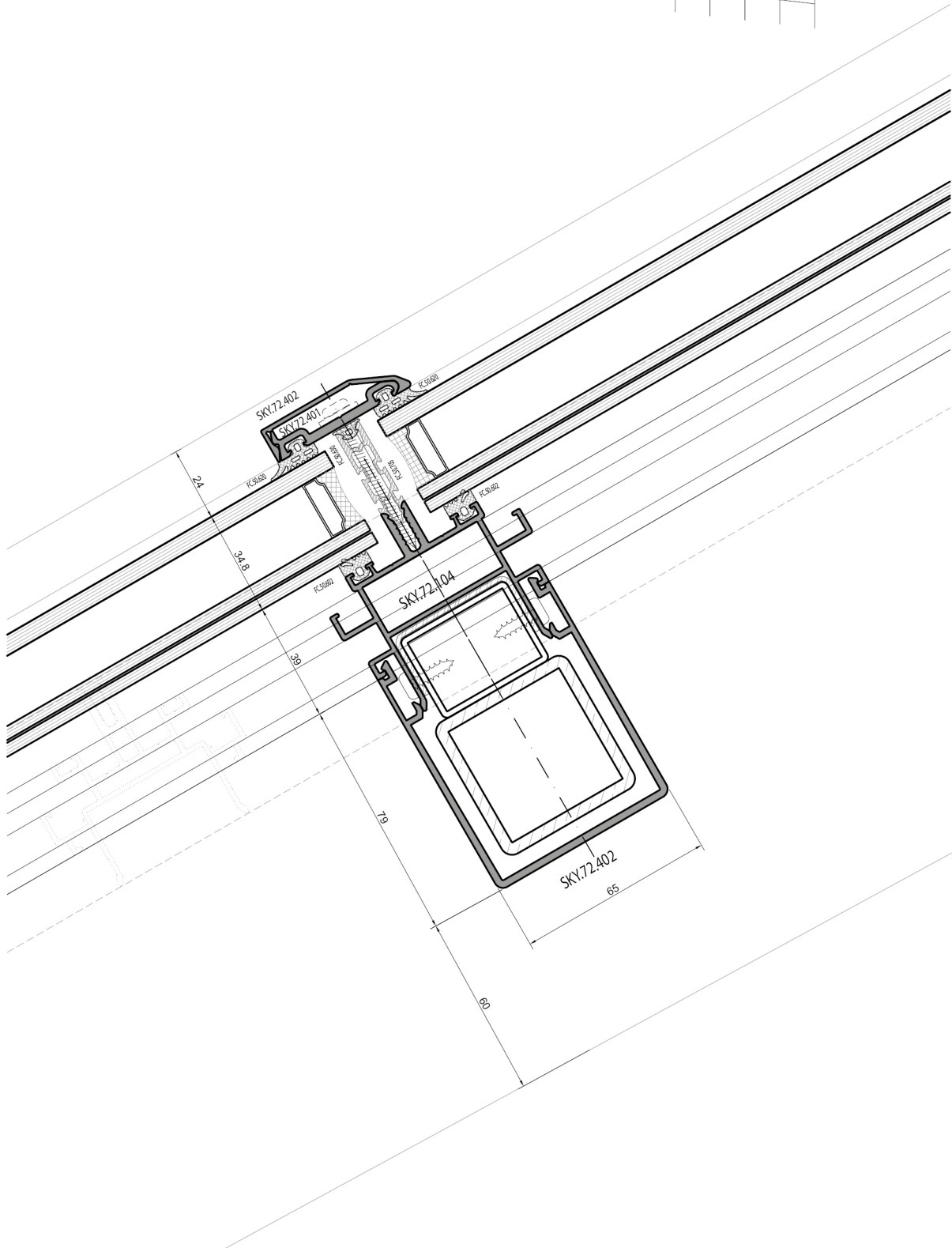
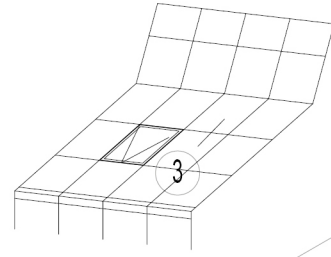

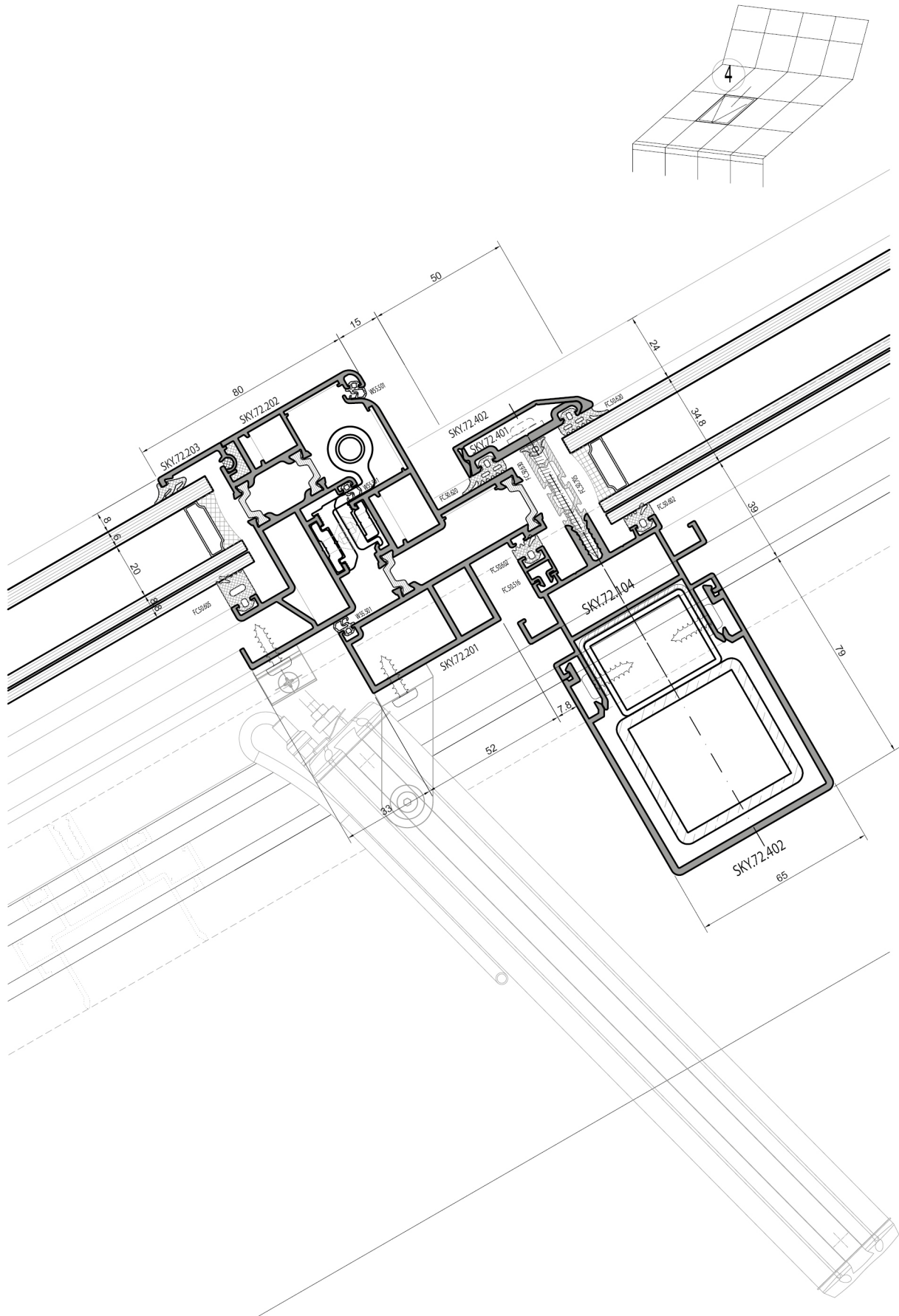

SKY72 IŞIKLIK SİSTEM / SKYLIGHT SYSTEM

YATAY DETAY / HORIZONTAL DETAIL

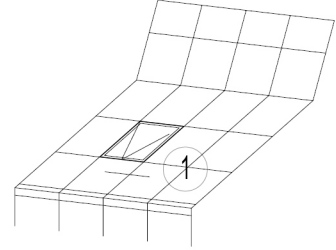

ALTERNATIF

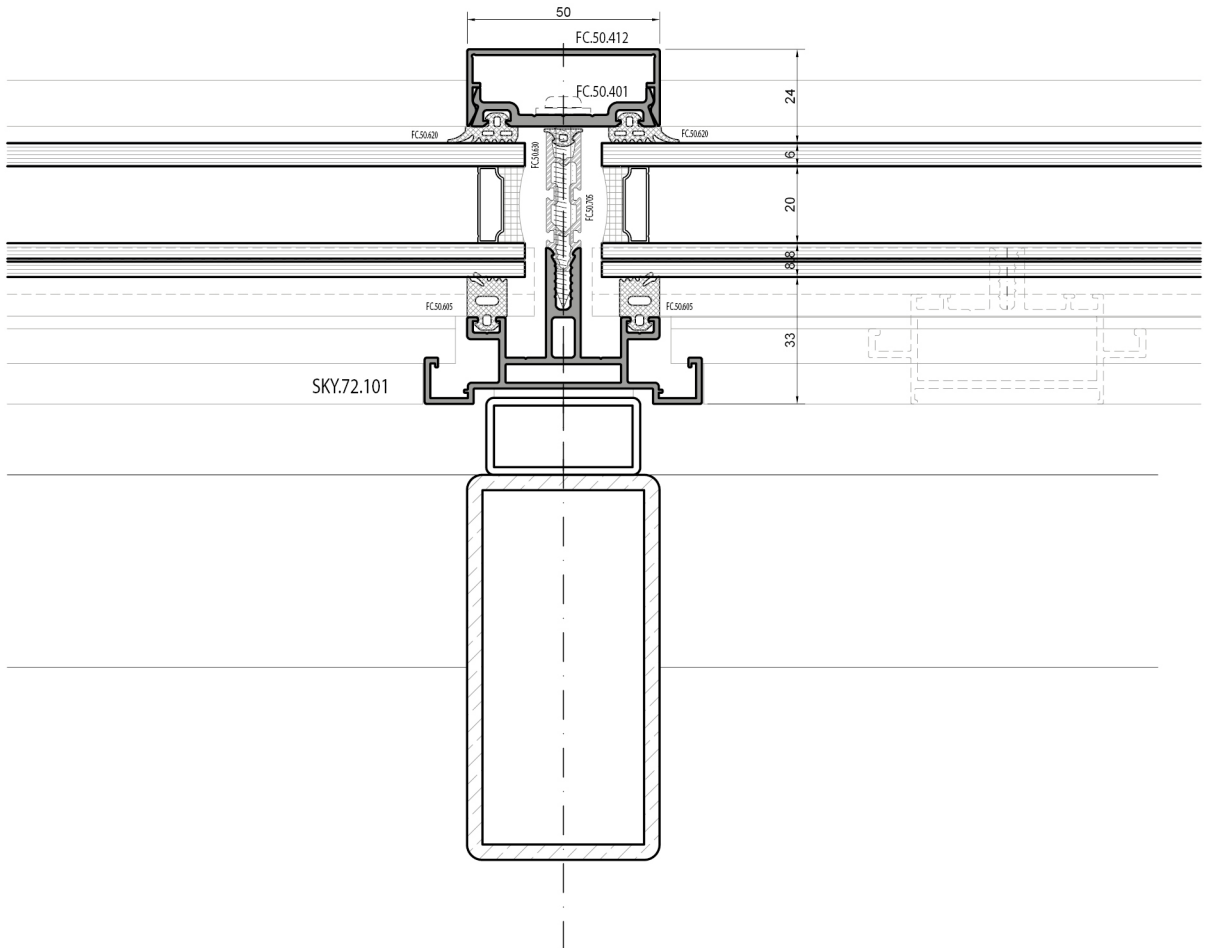

ALTERNATIF

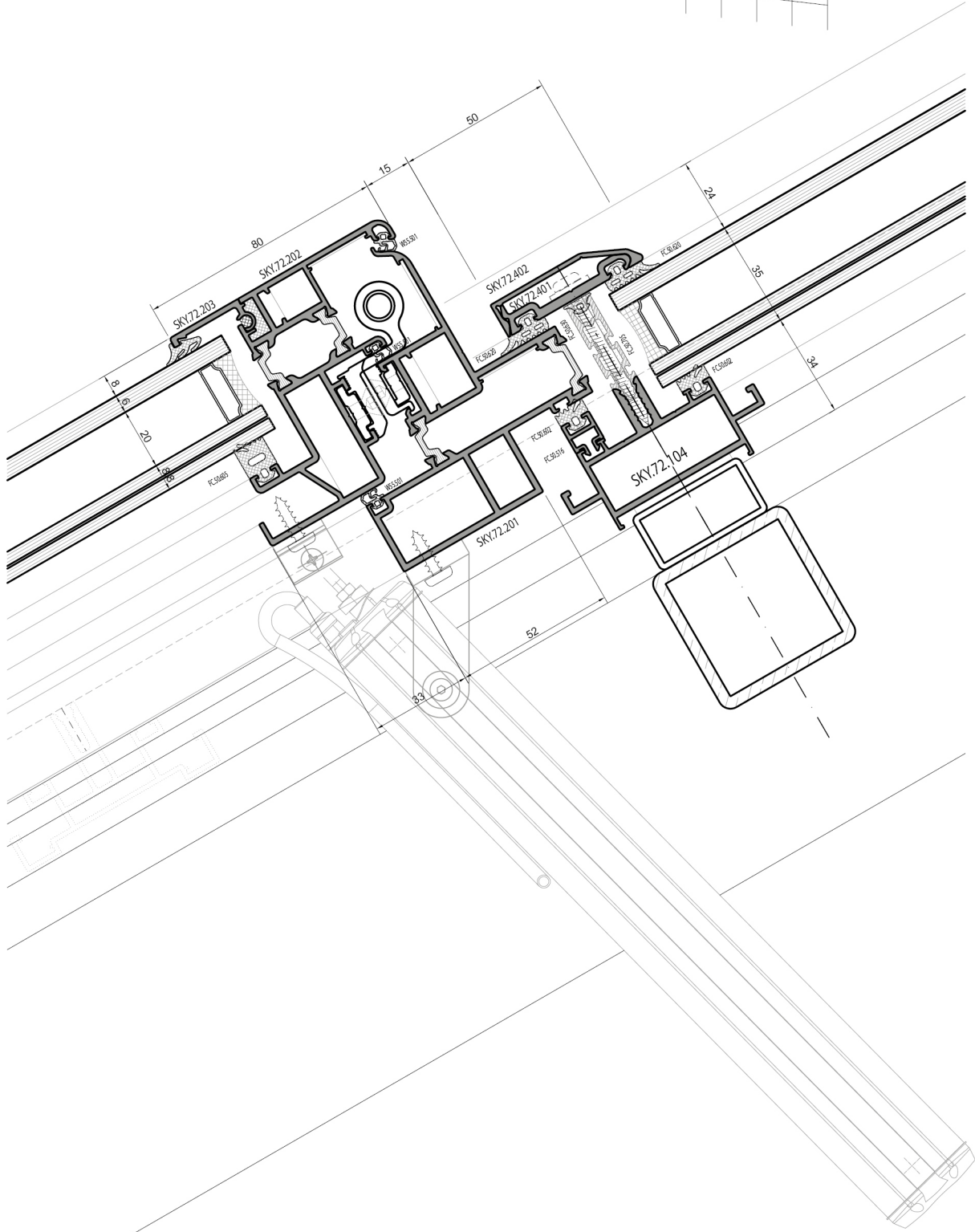
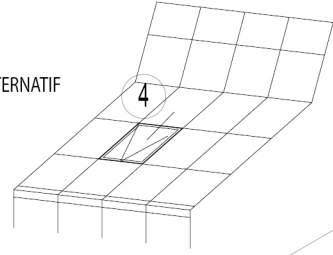

SKY72 IŞIKLIK SİSTEM / SKYLIGHT SYSTEM

YATAY DETAY / HORIZONTAL DETAIL

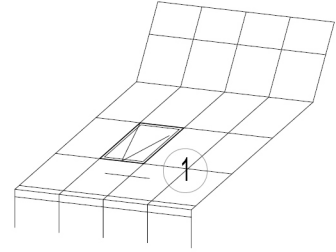

ALTERNATIF

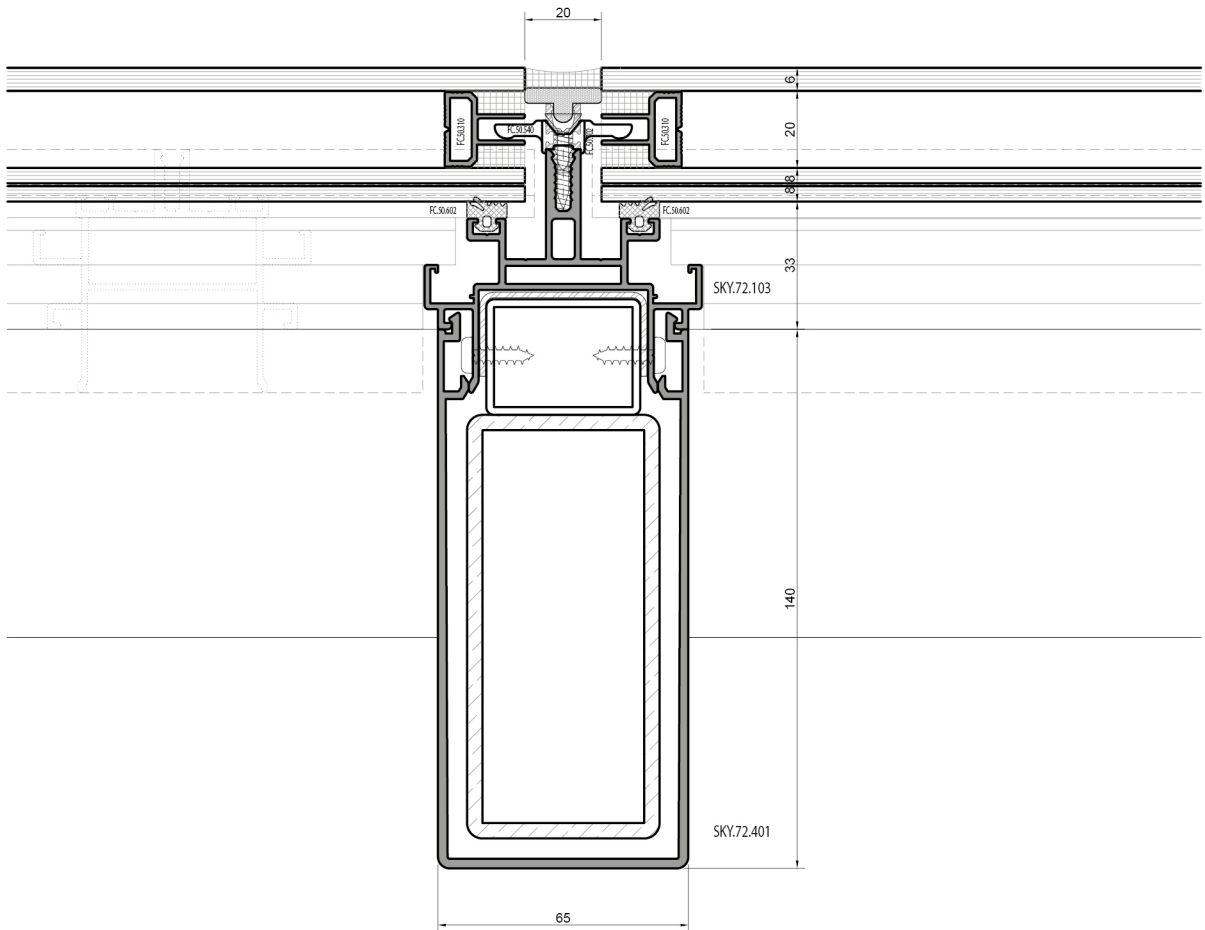

ALTERNATIF

