

# ASR 65

**Çelik Takviyeli Cephe Sistemi**  
Facade System With Reinforcement

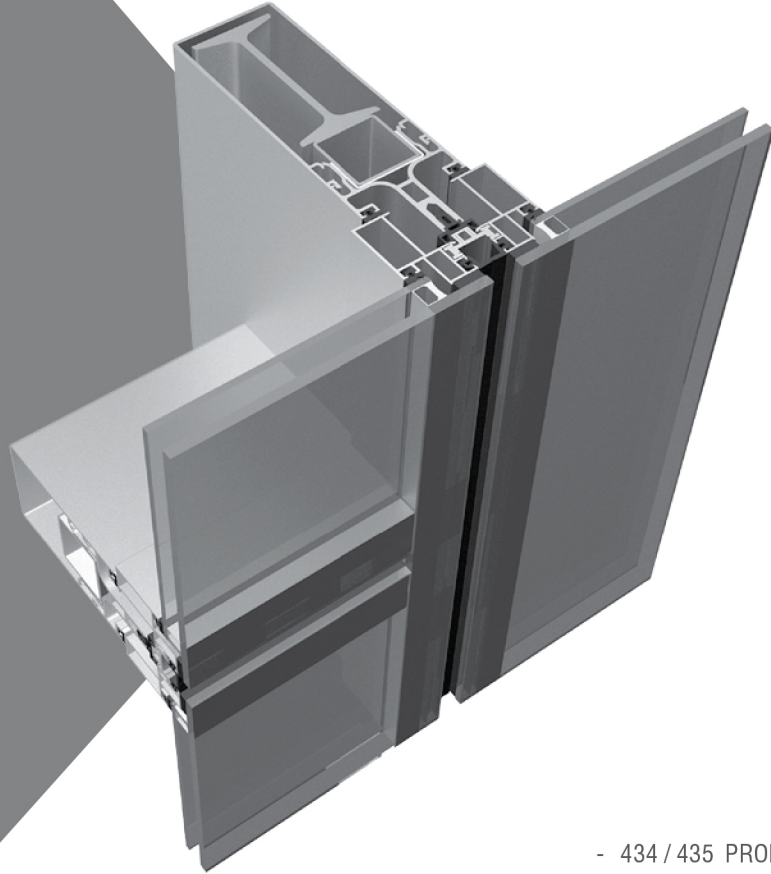

- 434 / 435 PROFİL KESİT DETAYLARI  
*PROFILE DETAIL DRAWINGS*
- 436 FİTİLLER  
*GASKETS*
- 437 / 438 AKSESUARLAR  
*ACCESSORIES*
- 439 / 442 SİSTEM DETAYLARI  
*SYSTEM DETAILS*

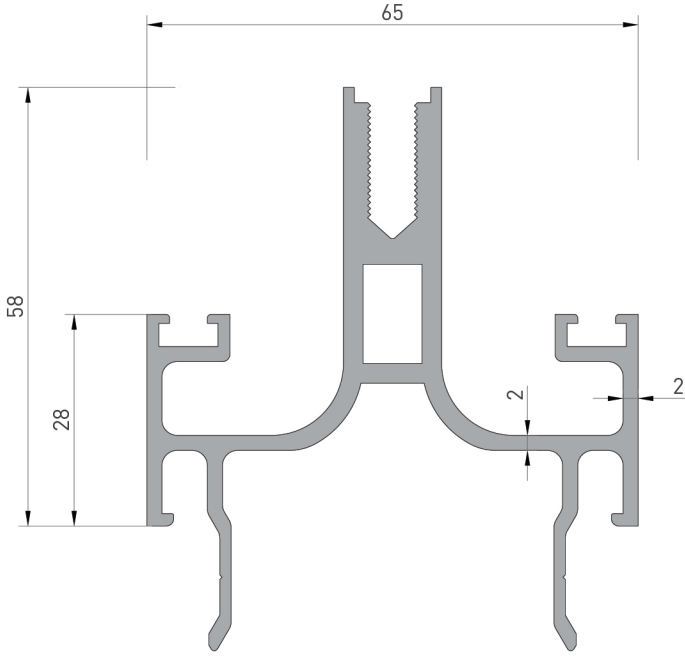

**2481**  
DÜŞEY TAŞIYICI  
MONTAJ PROFİLİ  
1.855 kg/mt  
Jx : 24.95 cm<sup>4</sup>  
Jy : 19.48 cm<sup>4</sup>

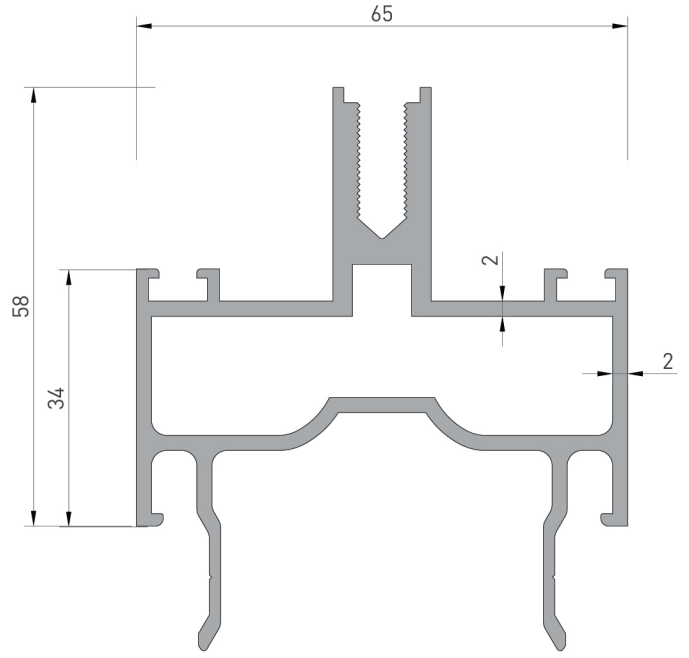

**2482**  
YATAY TAŞIYICI  
MONTAJ PROFİLİ  
1.900 kg/mt  
Jx : 28.22 cm<sup>4</sup>  
Jy : 20.14 cm<sup>4</sup>

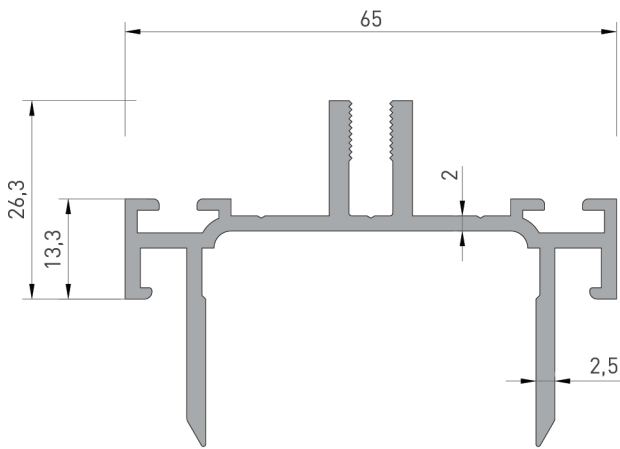

**2477**  
MONTAJ PROFİLİ  
1.095 kg/mt  
Jx : 18.00 cm<sup>4</sup>  
Jy : 4.16 cm<sup>4</sup>

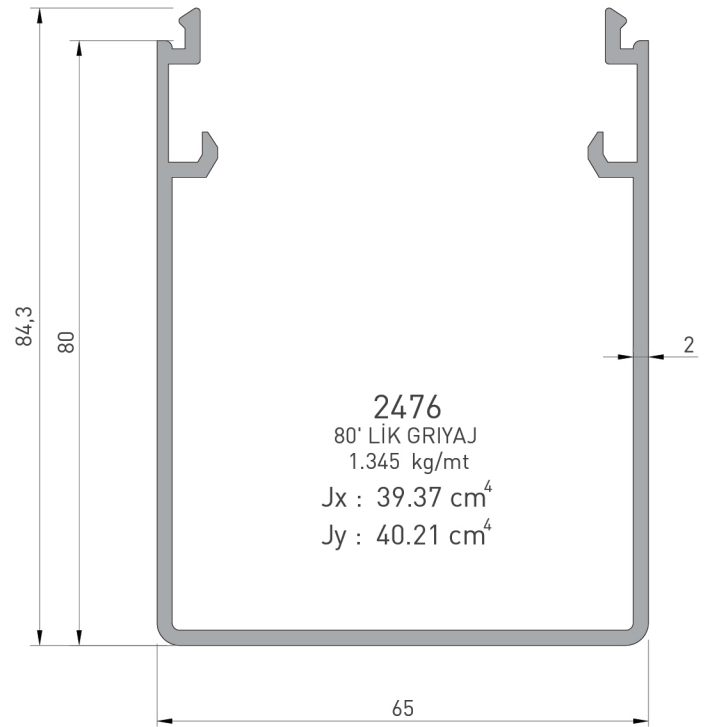

**2476**  
80° LİK GRIYAJ  
1.345 kg/mt  
Jx : 39.37 cm<sup>4</sup>  
Jy : 40.21 cm<sup>4</sup>

\* Belirtilen ağırlıklar Pres Profil için teorik kilogramlardır.  
\* Boyalı Profillerde ağırlığa % 5 ilave edilmesi gereklidir.

# ASR 65 ÇELİK TAKVİYELİ CEPHE SİSTEMİ

FACADE SYSTEM WITH STEEL REINFORCEMENT

PROFİL KESİT DETAYLARI / PROFILE DETAIL DRAWINGS

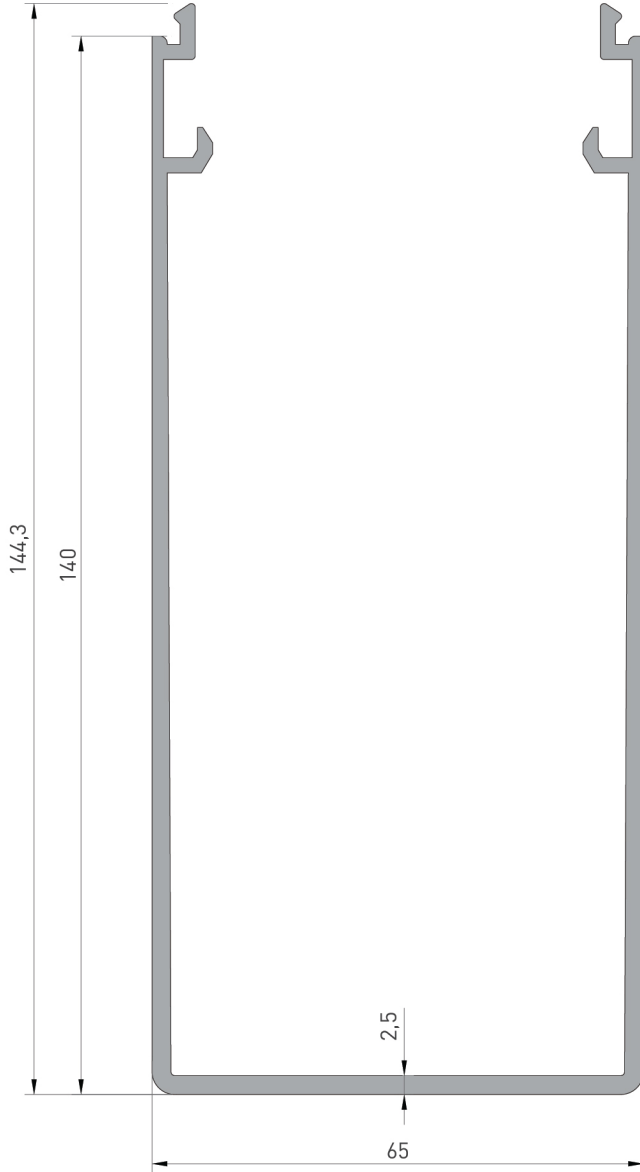
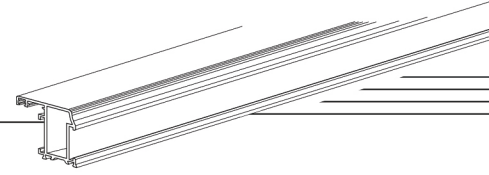

**2475**  
140' LİK GRİYAJ  
2.240 kg/mt  
Jx : 69.62 cm<sup>4</sup>  
Jy : 185.97 cm<sup>4</sup>

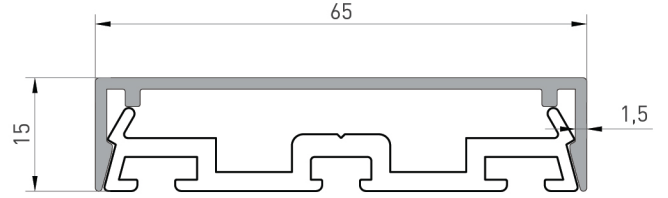

**2480**  
KAPAK PROFİL  
0.405 kg/mt

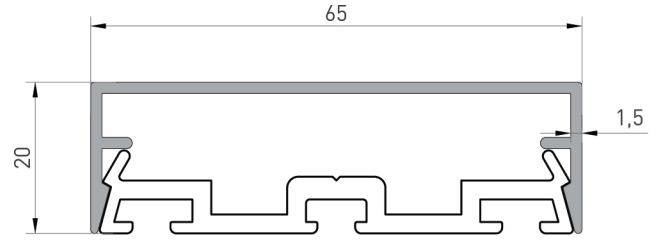

**2479**  
KAPAK PROFİL  
0.455 kg/mt

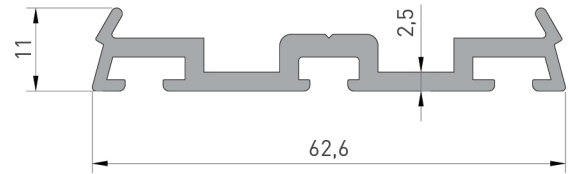





**2478**  
KAPAK PROFİL ALTI  
0.675 kg/mt



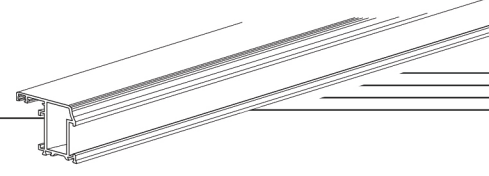

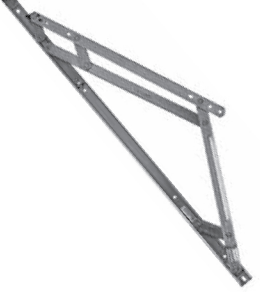
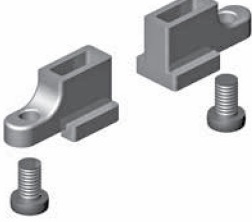

\* Belirtilen ağırlıklar Pres Profil için teorik kilogramlardır.  
\* Boyalı Profillerde ağırlığa % 5 ilave edilmesi gereklidir.

PROFİL ŞEKLİ DRAWING	PROFİL NO PROFILE NO	TANIMI DESCRIPTION	TEORİK AĞIRLIK THEORETICAL WEIGHT ( kg/mt )	SAYFA NUMARASI PAGE NUMBER	STATİK DEĞER STATICS	
					Jxx ( cm <sup>4</sup> )	Jyy ( cm <sup>4</sup> )
	Z-16	CEPHE KAPAK FİTİL GASKET	165 mt 75 gr/mt			
	Z-17	CEPHE FİTİL GASKET	220 mt 60 gr/mt			
	Z-37	CEPHE FİTİL GASKET	190 mt 63 gr/mt			
	Z-40	CEPHE FİTİL GASKET	125 mt 95 gr/mt			
	Z-32	KULAKLI FİTİL GASKET	185 mt 65 gr/mt			
	Z-52	CEPHE CAM FİTİL GASKET	200 mt 60 gr/mt			
	Z-28	CEPHE FİTİL GASKET	205 mt 59 gr/mt			
	Z-29	CEPHE FİTİL GASKET	80 mt 127 gr/mt			
	Z-30	CEPHE FİTİL GASKET	125 mt 98 gr/mt			
	Z-18	CEPHE CAM DIŞ FİTİL GASKET	170 mt 70 gr/mt			
	Z-19	CEPHE ORTA FİTİL GASKET	60 mt 175 gr/mt			





AKSESUAR ACCESSORY	SİPARİŞ KODU ORDER CODE	PAKET ADEDİ UNITS	AKSESUAR ACCESSORY	SİPARİŞ KODU ORDER CODE	PAKET ADEDİ UNITS
	GI12-5			GI03-27	
PARALEL MAKAS			KIVRIK KOL (ÇİFT MAÇA)		
	GI12	GS HD-10" P TİPİ 08534000N GS HD-12" P TİPİ 08535000N GS HD-14" P TİPİ 08536000N GS HD-16" P TİPİ 08537000N GS HD-18" P TİPİ 08538000N GS HD-20" P TİPİ 08539000N GS HD-22" P TİPİ 08540000N GS HD-24" P TİPİ 08541000N GS HD-28" P TİPİ 08542000N		GI30-3	
TERS VAŞİSTAS MAKAS			BAGLANTI ELEMANI		
	GI03-20				
KIVRIK KOL					
	GI03-21				
KIVRIK KOL (KEY ANAHTARLI)					

AKSESUAR ACCESSORY	SİPARİŞ KODU ORDER CODE	PAKET ADEDİ UNITS	AKSESUAR ACCESSORY	SİPARİŞ KODU ORDER CODE	PAKET ADEDİ UNITS
 <p>AYARLI PİM</p>	Gl34-2		 <p>ÜST KİLİTLEME ELEMANI</p>	Gl33-3	
 <p>KÖŞE DÖNME</p>	Gl23-1		 <p>KİLİT PİMİ</p>	Gl33-2	
 <p>LİMİTLEME MAKASI</p>	Gl13		 <p>KASET SABİTLEME TAKOZU</p>	CP03	
			 <p>SABİT KARŞILIK</p>	Z435	

# ASR 65 ÇELİK TAKVİYELİ CEPHE SİSTEMİ

## FACADE SYSTEM WITH STEEL REINFORCEMENT

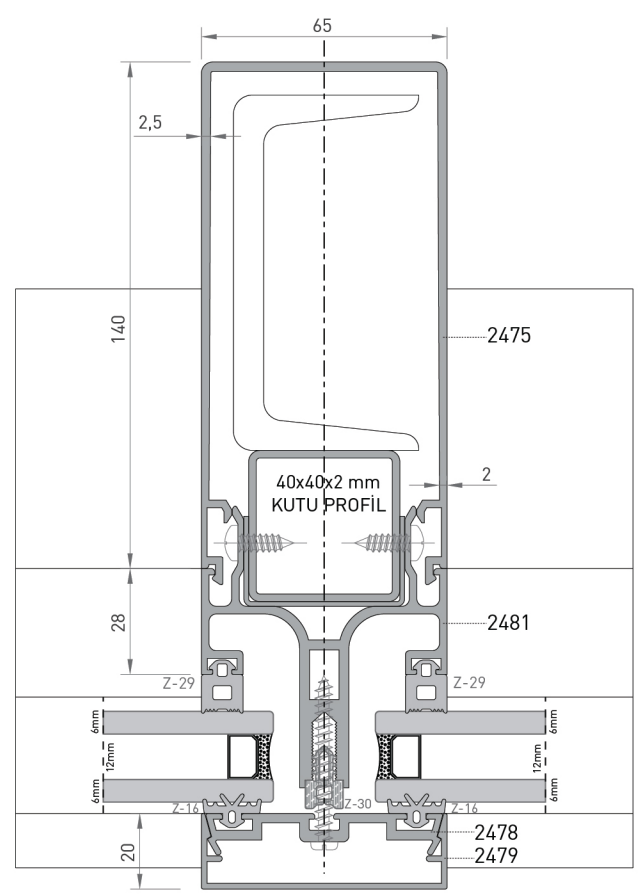
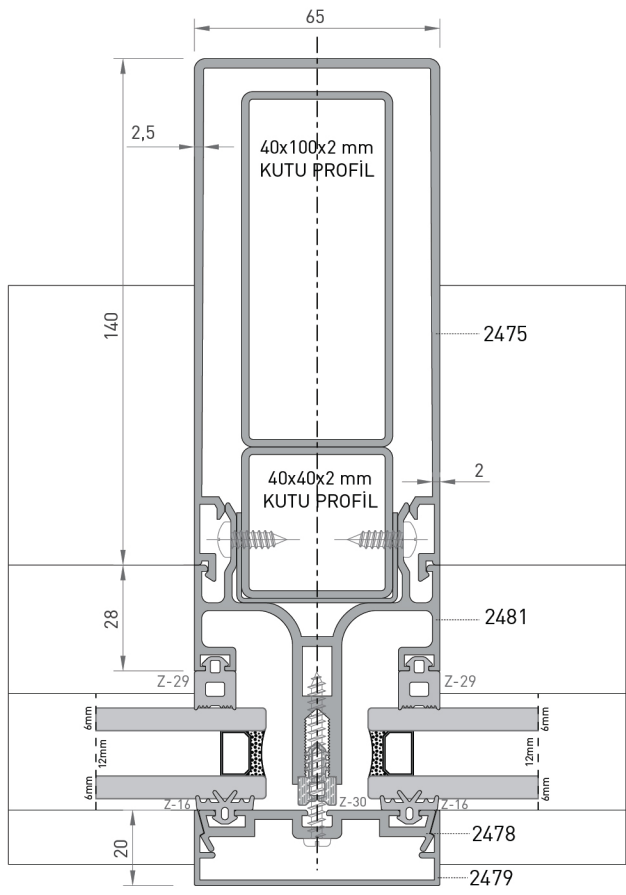
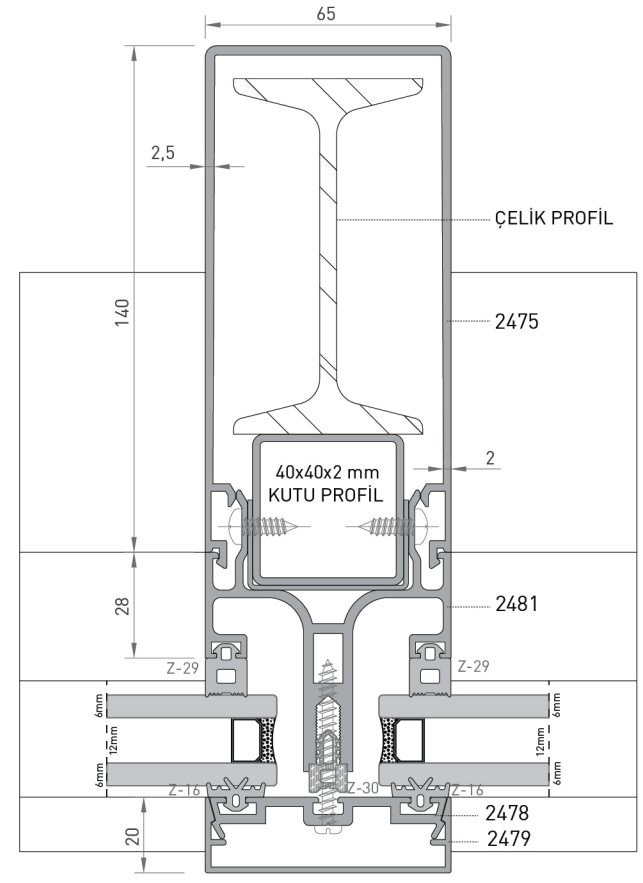
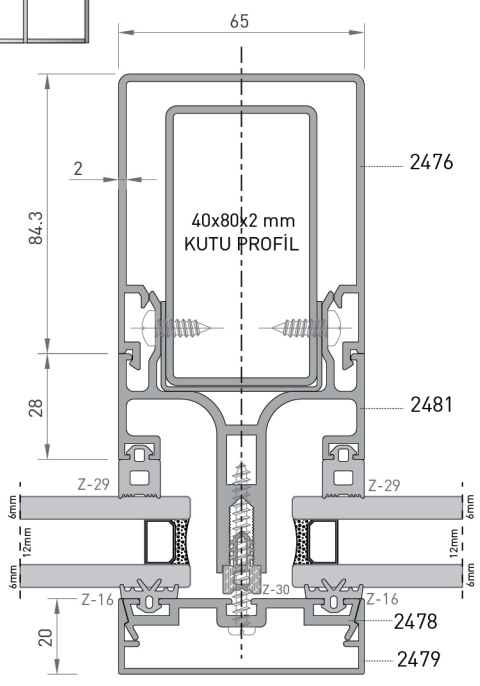
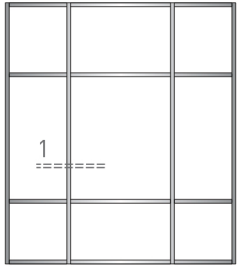
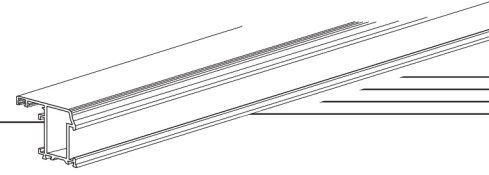

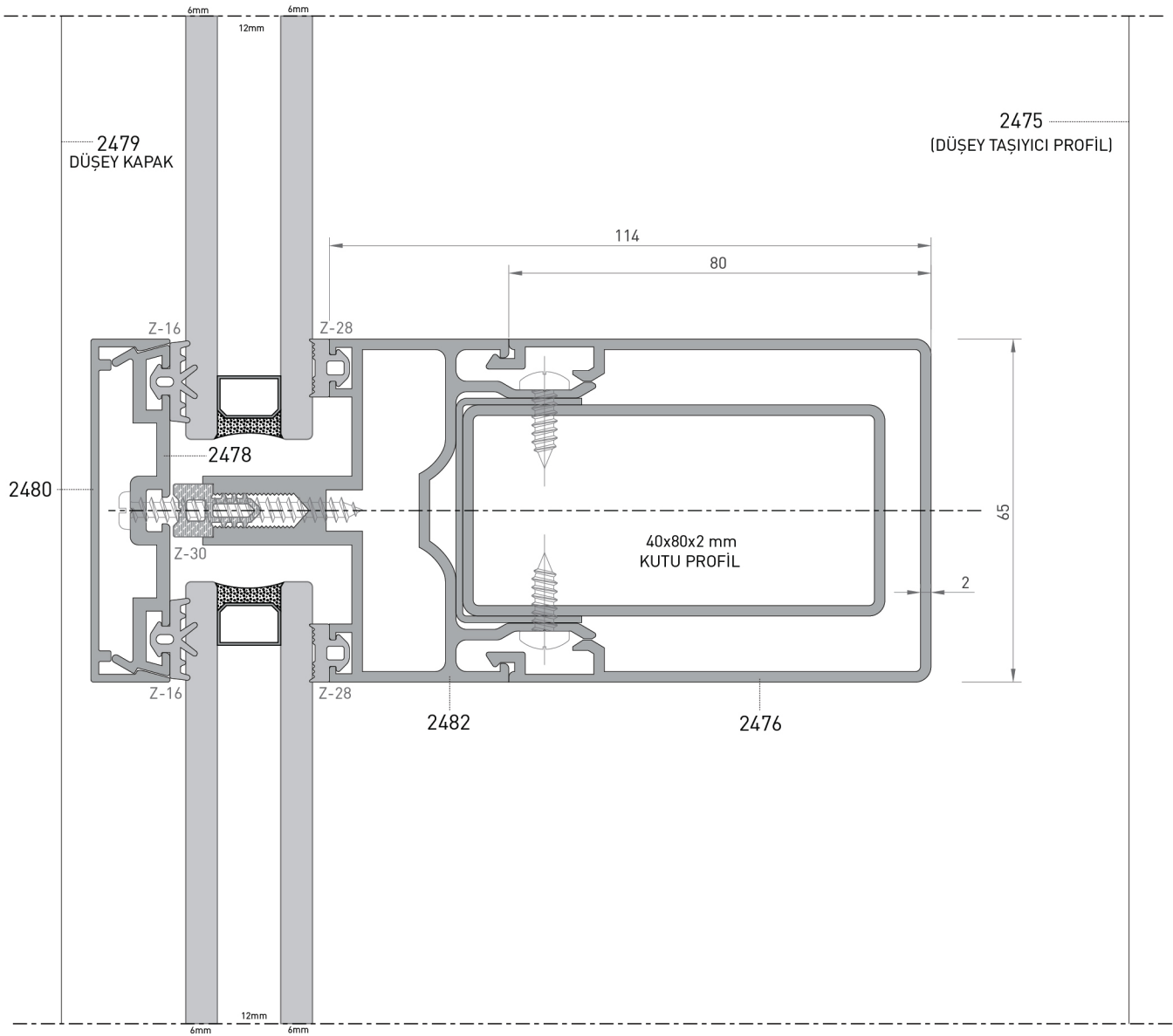
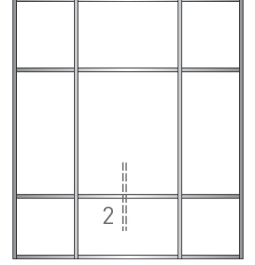

# ASR 65 ÇELİK TAKVİYELİ CEPHE SİSTEMİ

FACADE SYSTEM WITH STEEL REINFORCEMENT

SİSTEM DETAYI / SYSTEM DETAILS

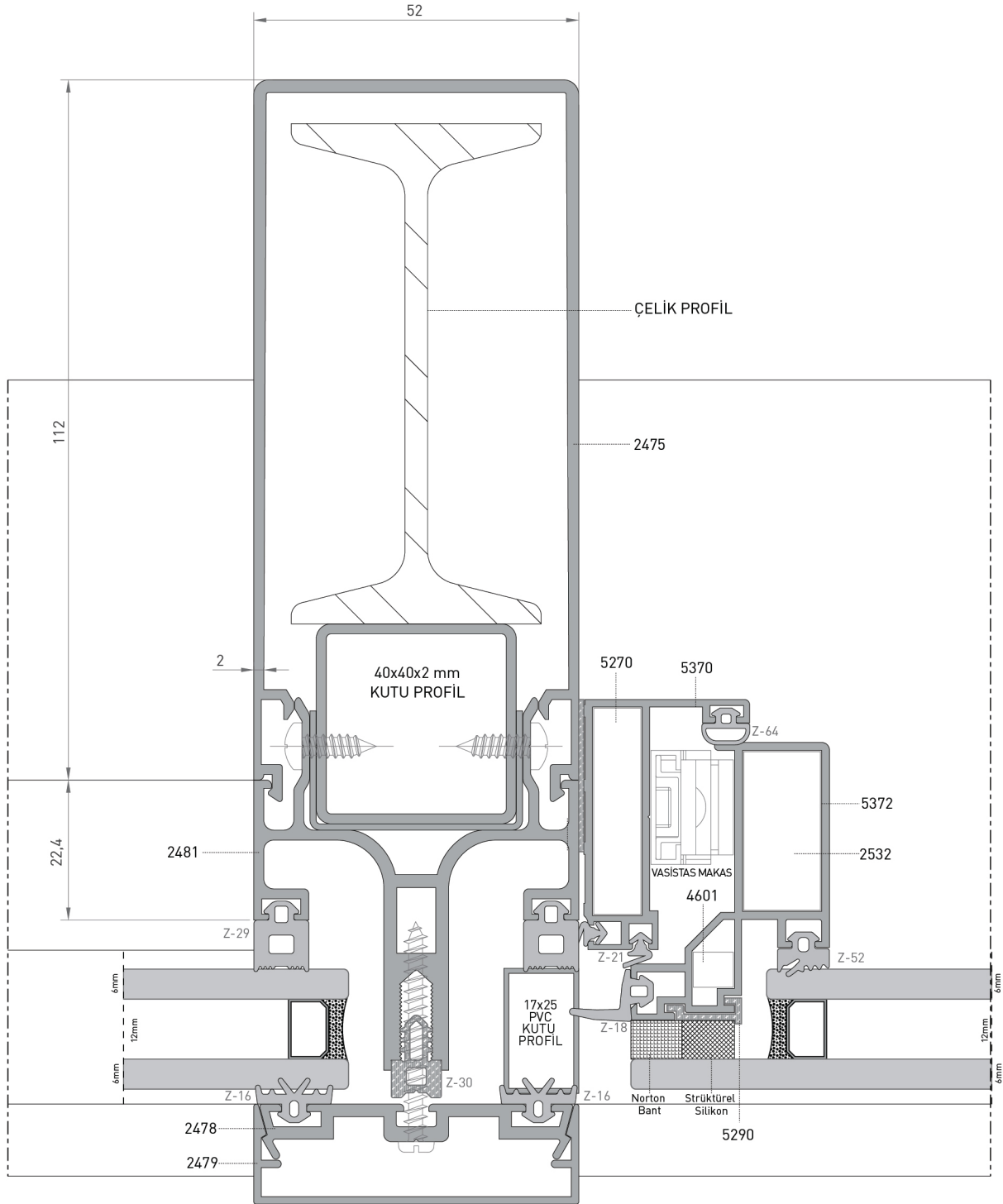
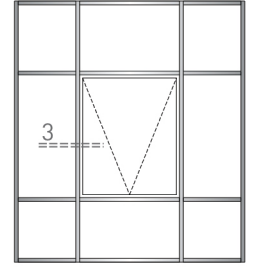
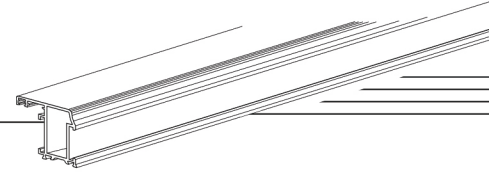

4/5 ORANINDA KÜÇÜLTÜLMÜŞTÜR.

