

* Belirtilen ağırlıklar Pres Profil için teorik kilogramlardır.
* Boyalı Profillerde ağırlığa % 5 ilave edilmesi gereklidir.

KUTU PROFİLLERİ

BOX PROFILES

PROFİL KESİT DETAYLARI / PROFILE DETAIL DRAWINGS

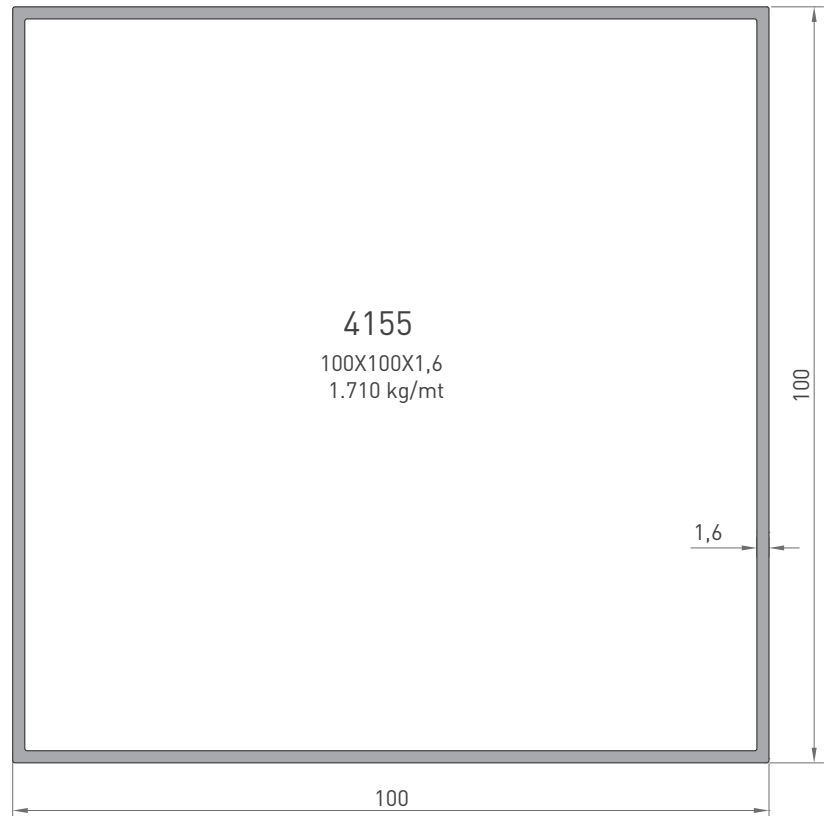
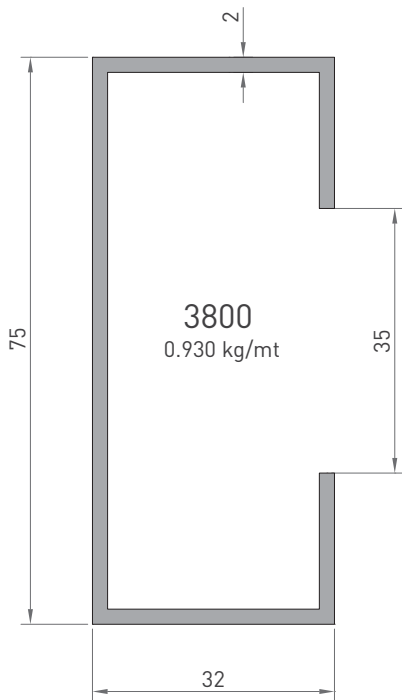
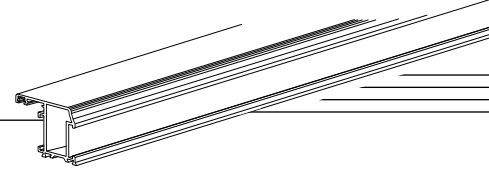

* Belirtilen ağırlıklar Pres Profil için teorik kilogramlardır.
* Boyalı Profillerde ağırlığa % 5 ilave edilmesi gereklidir.

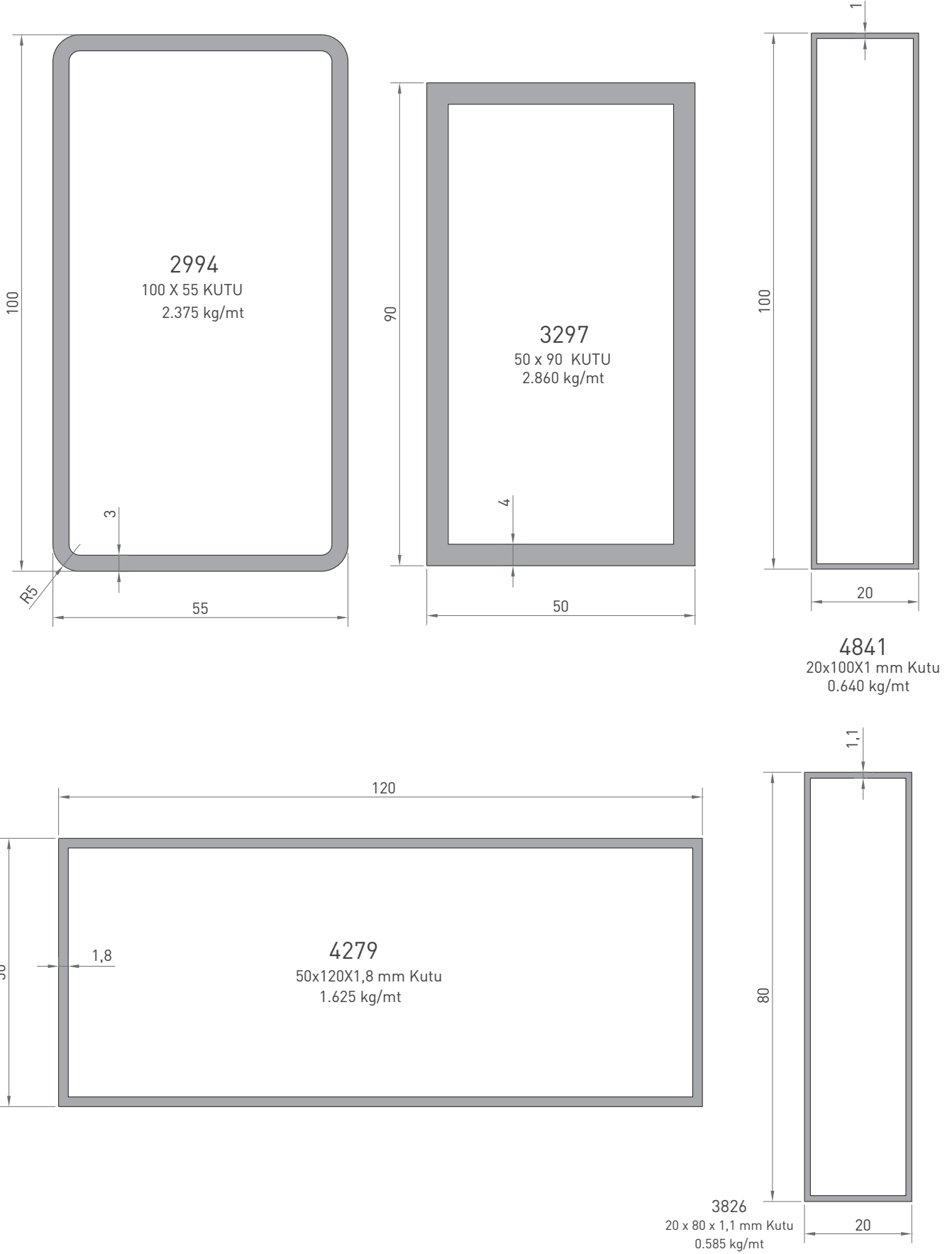

* Belirtilen ağırlıklar Pres Profil için teorik kilogramlardır.
* Boyalı Profillerde ağırlığa % 5 ilave edilmesi gereklidir.

KUTU PROFİLLERİ

BOX PROFILES

PROFİL KESİT DETAYLARI / PROFILE DETAIL DRAWINGS

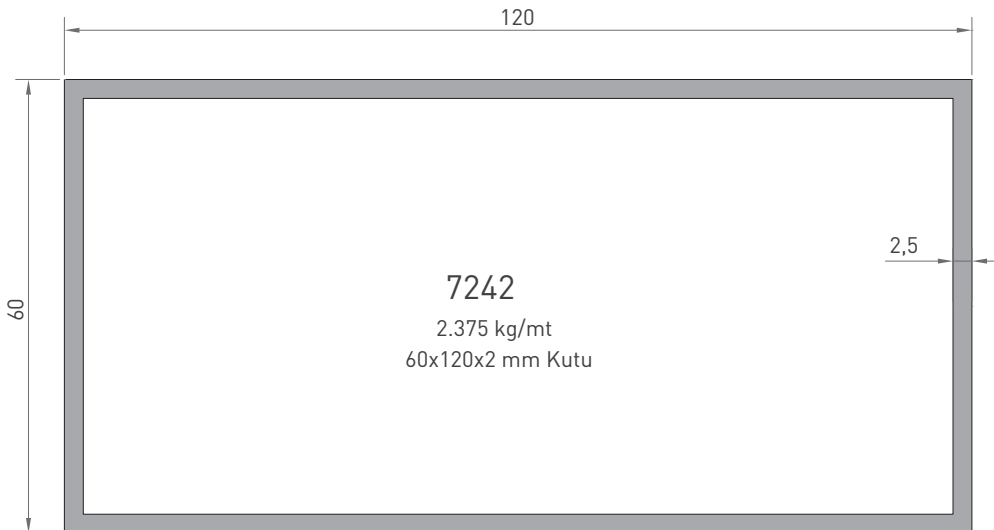
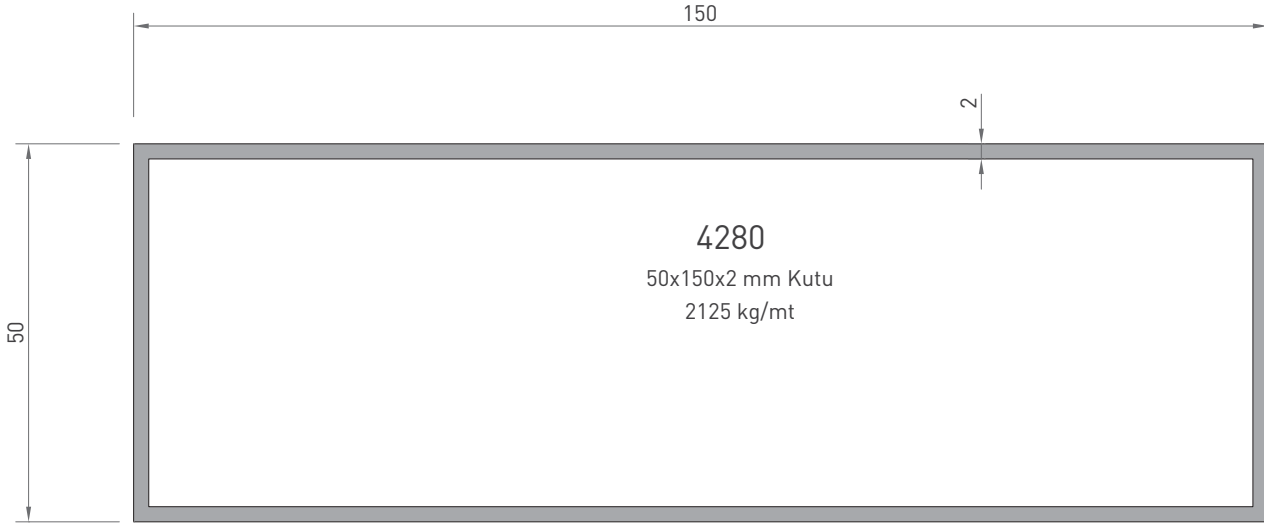
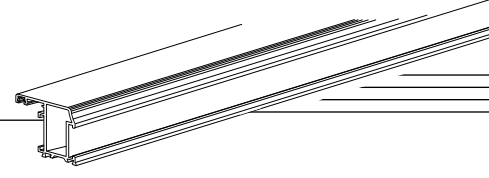

* Belirtilen ağırlıklar Pres Profil için teorik kilogramlardır.
* Boyalı Profillerde ağırlığa % 5 ilave edilmesi gereklidir.

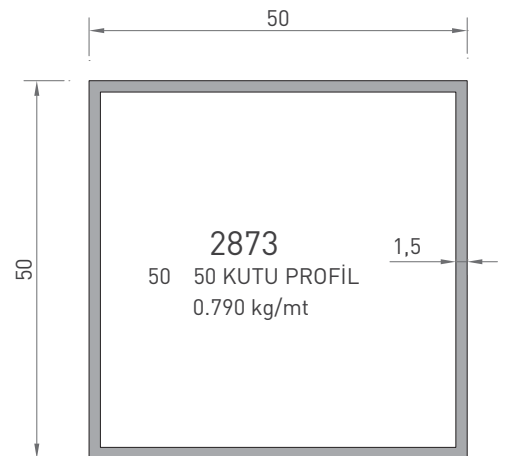
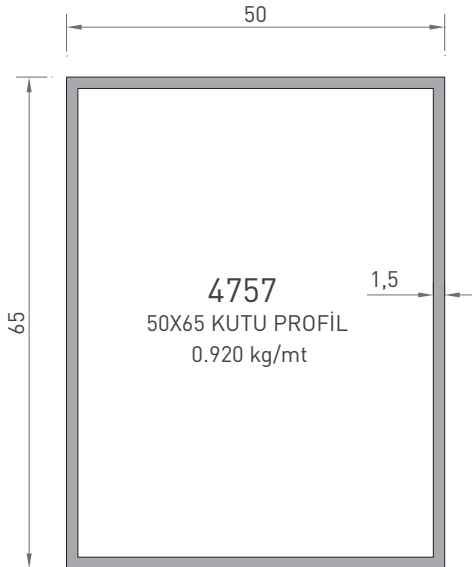
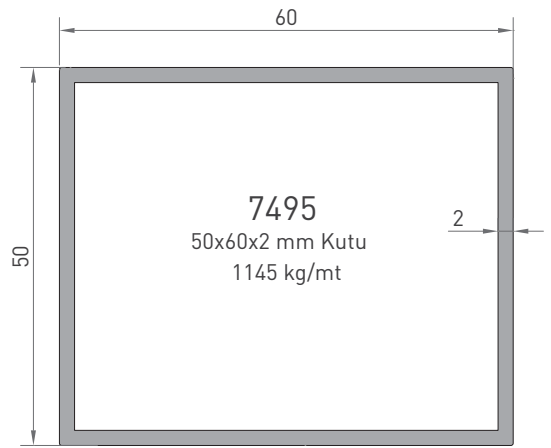
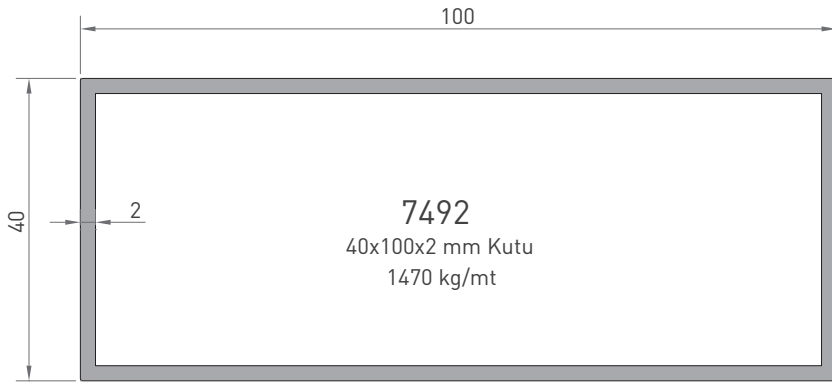
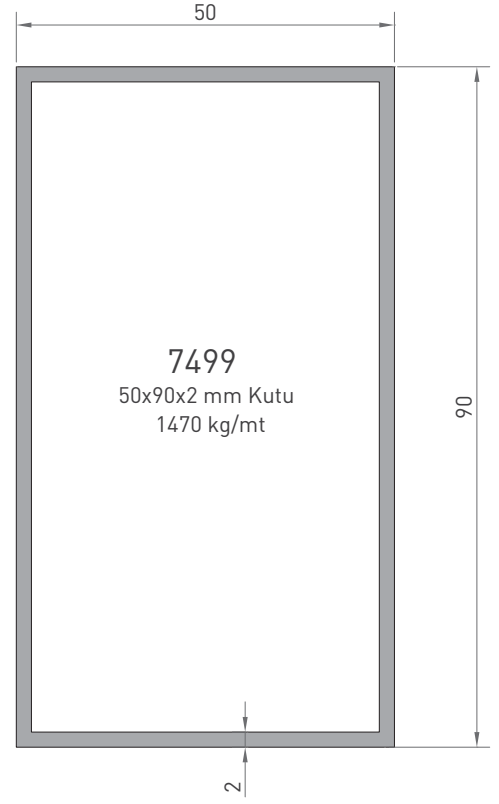

* Belirtilen ağırlıklar Pres Profil için teorik kilogramlardır.
* Boyalı Profillerde ağırlığa % 5 ilave edilmesi gereklidir.

KUTU PROFİLLERİ

BOX PROFILES

PROFİL KESİT DETAYLARI / PROFILE DETAIL DRAWINGS

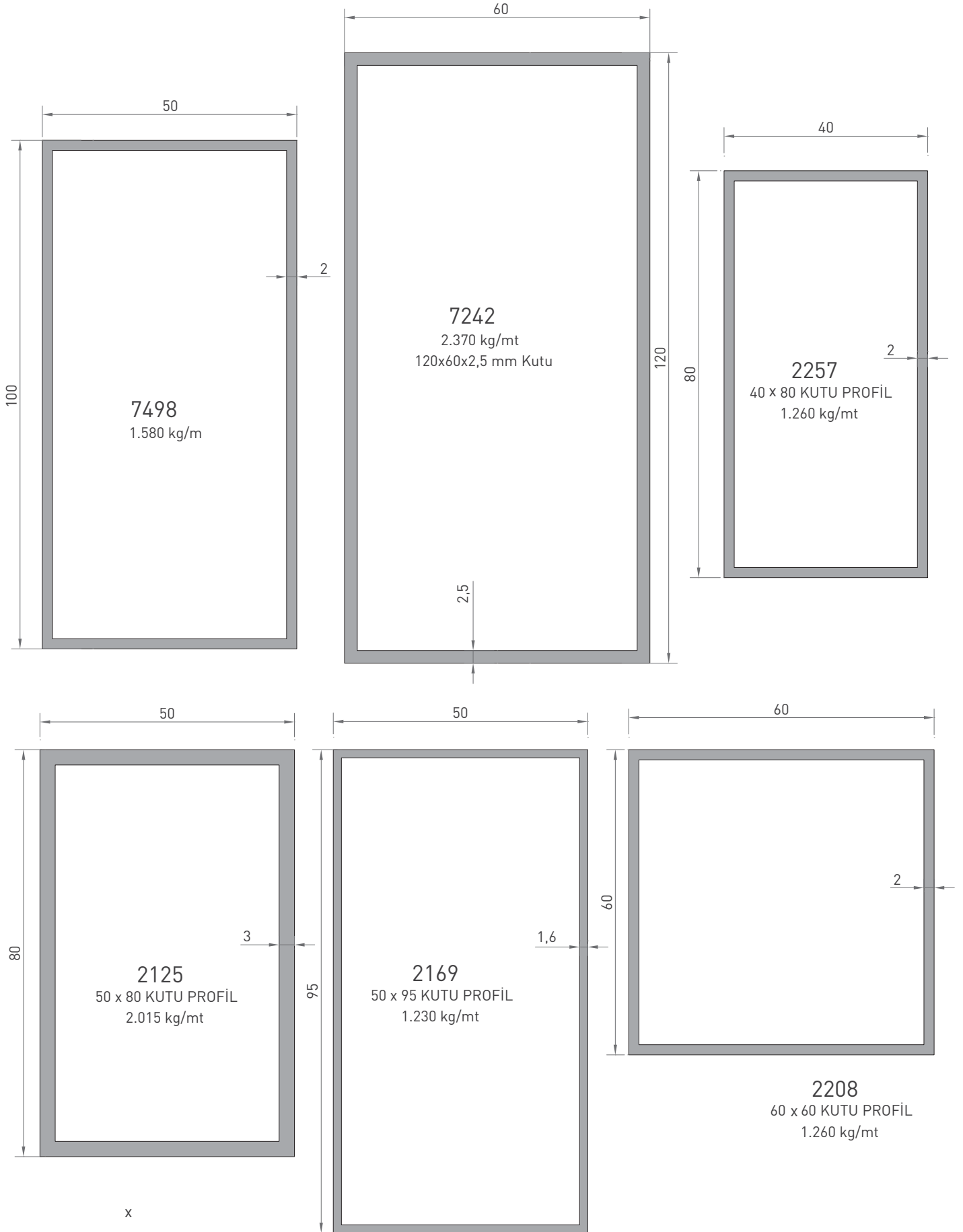
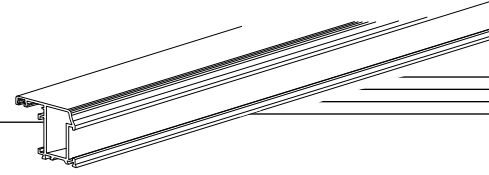

* Belirtilen ağırlıklar Pres Profil için teorik kilogramlardır.
* Boyalı Profillerde ağırlığa % 5 ilave edilmesi gereklidir.

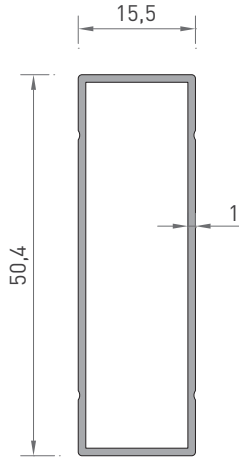

2409
15 x 50 KUTU PROFİL
0.345 kg/mt

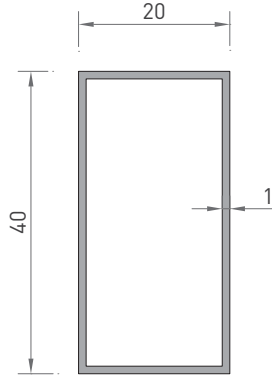

2230
20 x 40 KUTU PROFİL
0.315 kg/mt

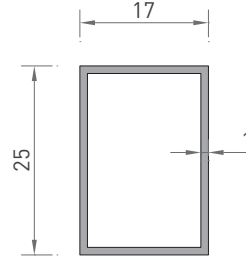

2167
17 x 25 KUTU PROFİL
0.215 kg/mt

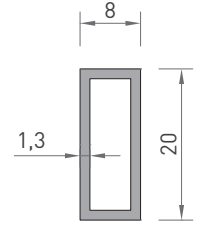

4398
8 x 20 KUTU PROFİL
0.180 kg/mt

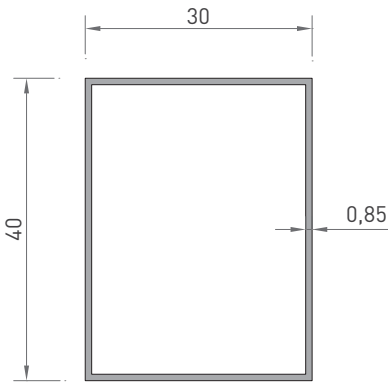

2173
30 x 40 KUTU PROFİL
0.315 kg/mt

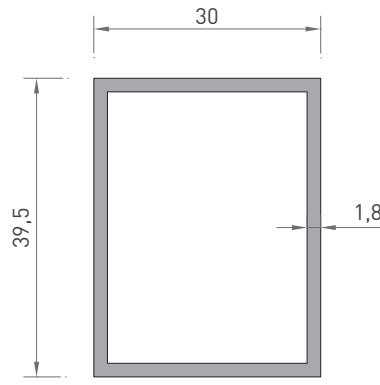

2408
30 x 40 KUTU PROFİL
0.650 kg/mt

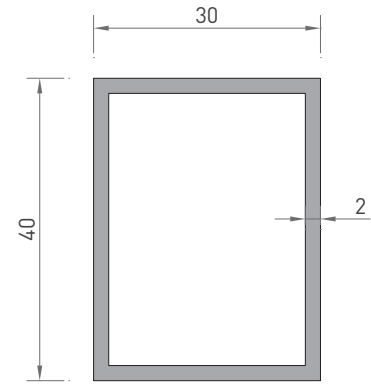

2396
30 x 40 KUTU PROFİL
0.720 kg/mt

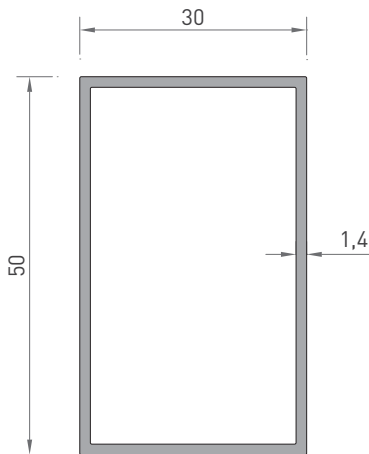

4700
30 x 50 KUTU PROFİL
0.590 kg/mt

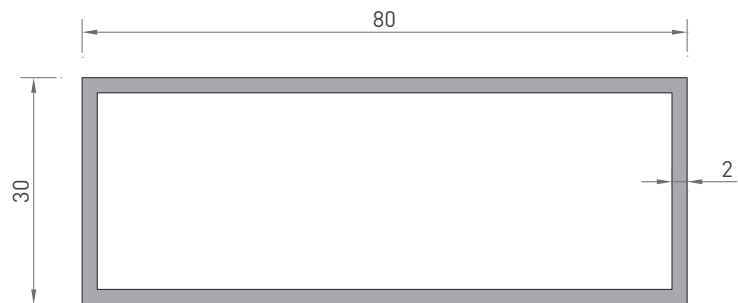

2211
30 x 80 KUTU PROFİL
1.150 kg/mt

* Belirtilen ağırlıklar Pres Profil için teorik kilogramlardır.
* Boyalı Profillerde ağırlığa % 5 ilave edilmesi gereklidir.

KUTU PROFİLLERİ

BOX PROFILES

PROFİL KESİT DETAYLARI / PROFILE DETAIL DRAWINGS

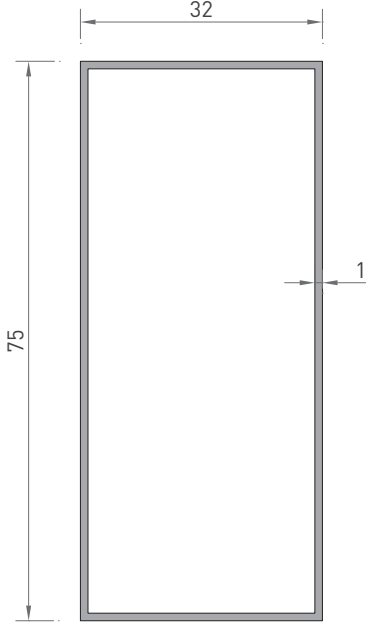
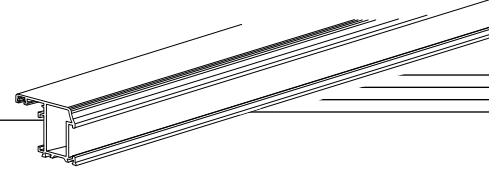

2168
32 x 75 KUTU PROFİL
0.565 kg/mt

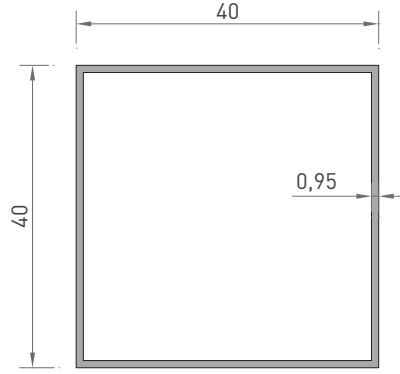

2116
40 x 40 KUTU PROFİL
0.405 kg/mt

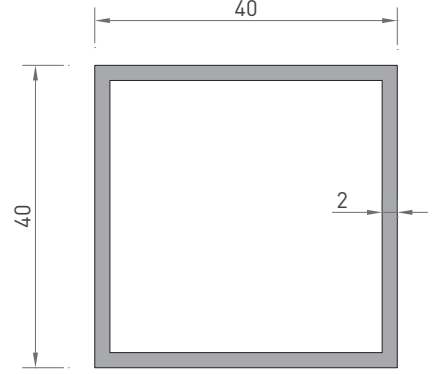

2209
40 x 40 KUTU PROFİL
0.825 kg/mt

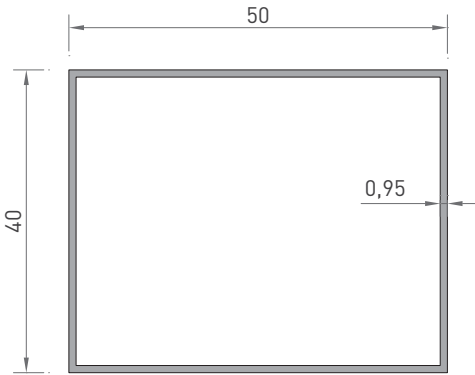

2129
40 x 50 KUTU PROFİL
0.460 kg/mt

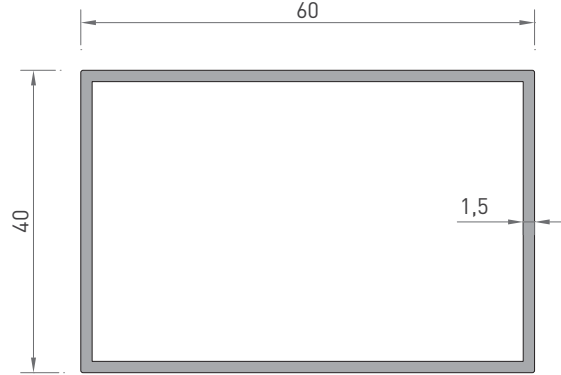

4716
40 x 60 KUTU PROFİL
0.795 kg/mt

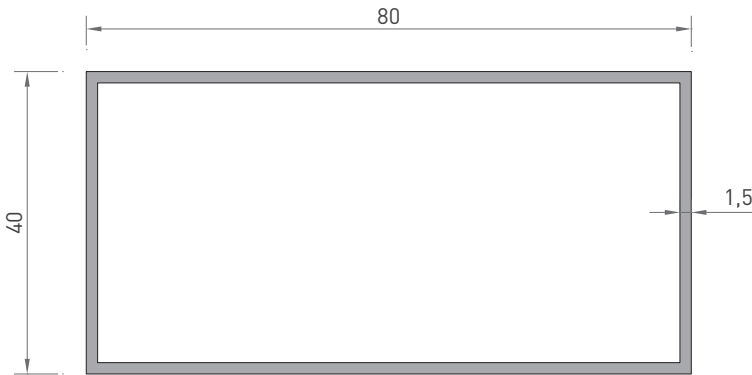

2220
40 x 80 KUTU PROFİL
0.950 kg/mt

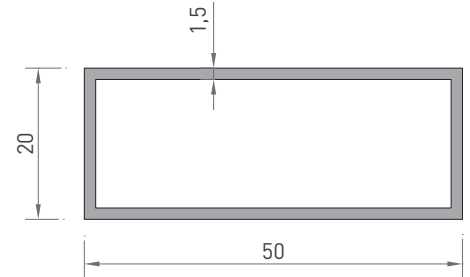

4717
20 x 50 KUTU PROFİL
0.550 kg/mt

* Belirtilen ağırlıklar Pres Profil için teorik kilogramlardır.
* Boyalı Profillerde ağırlığa % 5 ilave edilmesi gereklidir.

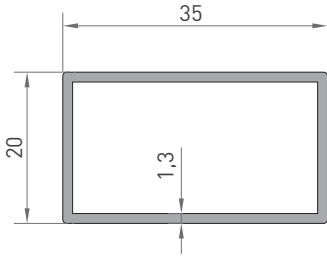

3661
KUTU PROFİLİ
0.370 kg/mt

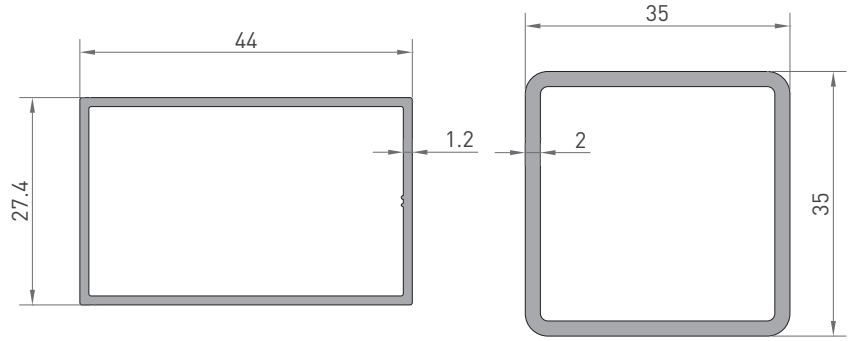

3708
27.5 X 44 KUTU
0.445 kg/mt

2972
35 X 35 KUTU
0.700 kg/mt

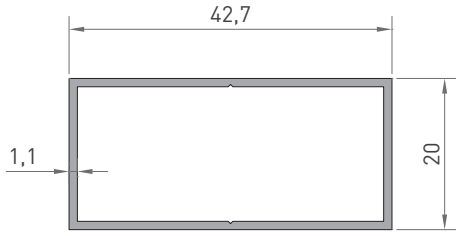

4302
KUTU PROFİLİ
0.365 kg / mt

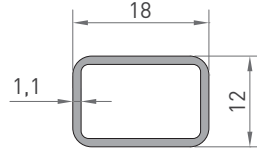

2984
18 X 12 KUTU
0.155 kg/mt

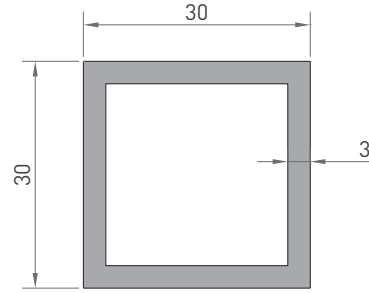

7818
KUTU PROFİLİ
0.878 kg/mt

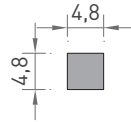

2887
PERDE ÇUBUK
0.065 kg/mt

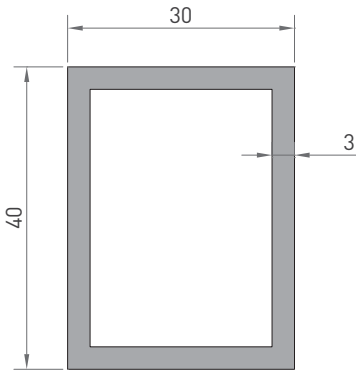

7817
KUTU PROFİLİ
1.041 kg/mt

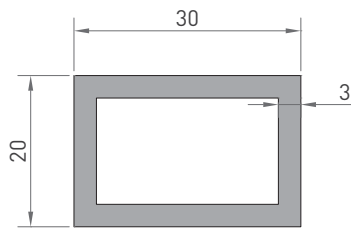

7819
KUTU PROFİLİ
0.715 kg/mt

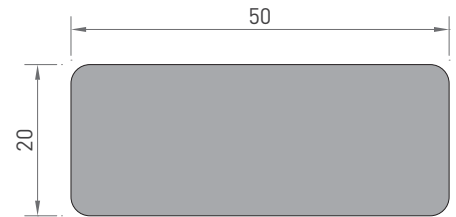

2815
50 x 20 DOLU KUTU
PROFİL
2.695 kg/mt

* Belirtilen ağırlıklar Pres Profil için teorik kilogramlardır.
* Boyalı Profillerde ağırlığa % 5 ilave edilmesi gereklidir.

KUTU PROFİLLERİ

BOX PROFILES

PROFİL KESİT DETAYLARI / PROFILE DETAIL DRAWINGS

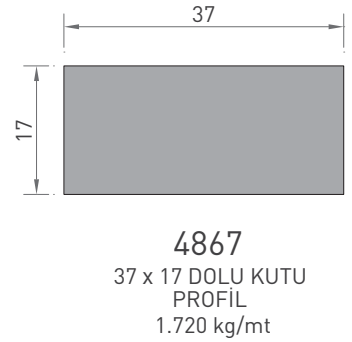
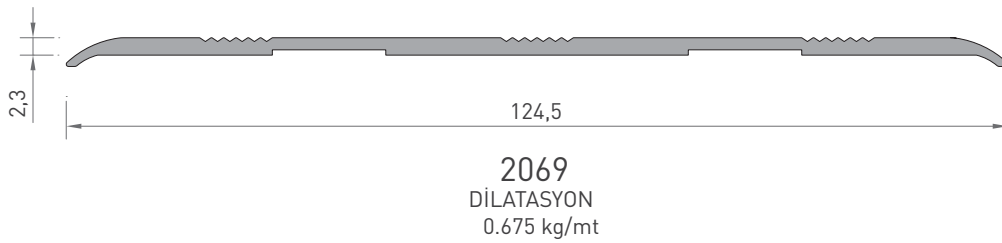
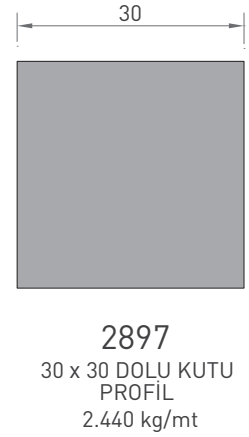
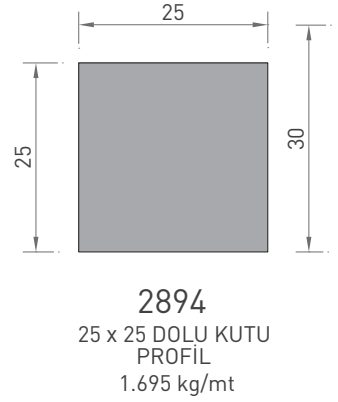
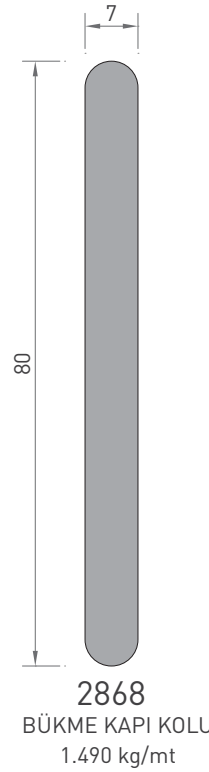
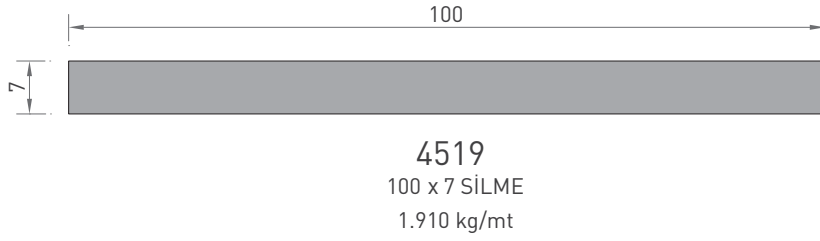
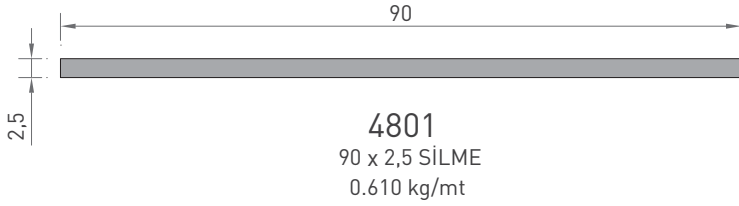
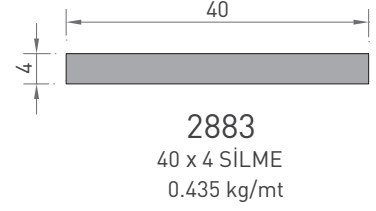
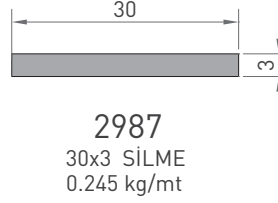
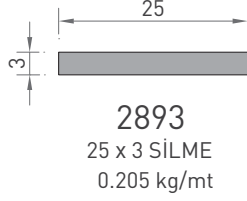
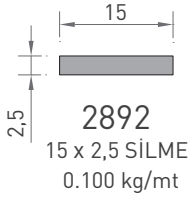
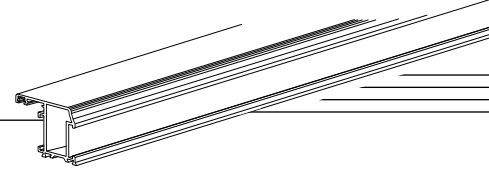

* Belirtilen ağırlıklar Pres Profil için teorik kilogramlardır.
* Boyalı Profillerde ağırlığa % 5 ilave edilmesi gereklidir.

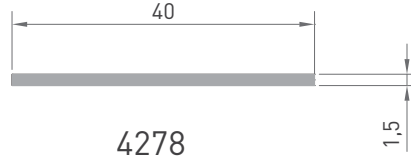

4278
40x1,5 SİLME
0.160 kg/mt

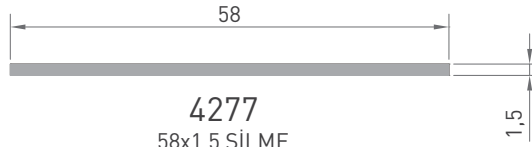

4277
58x1,5 SİLME
0.235 kg/mt

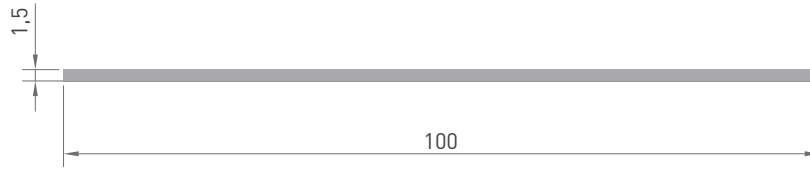

4276
100x1,5 SİLME
0.410 kg/mt

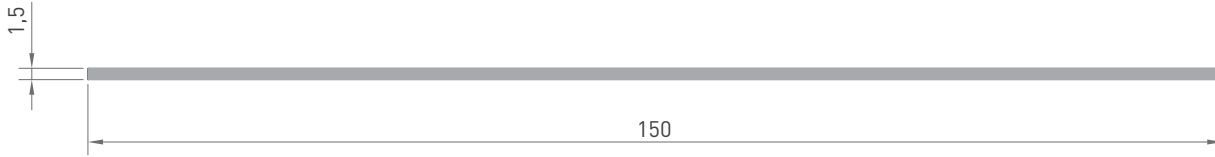

4275
150x1,5 SİLME
0.610 kg/mt

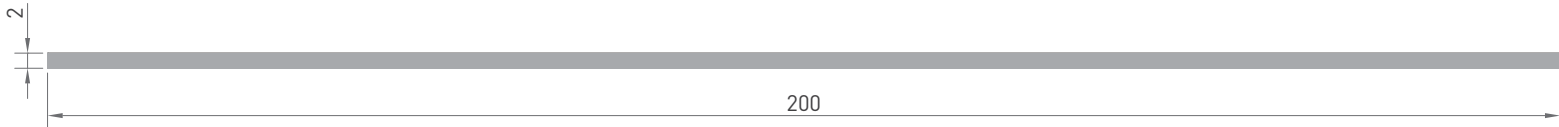

4274
200x1,5 SİLME
1.084 kg/mt