

Giyotin Sistem

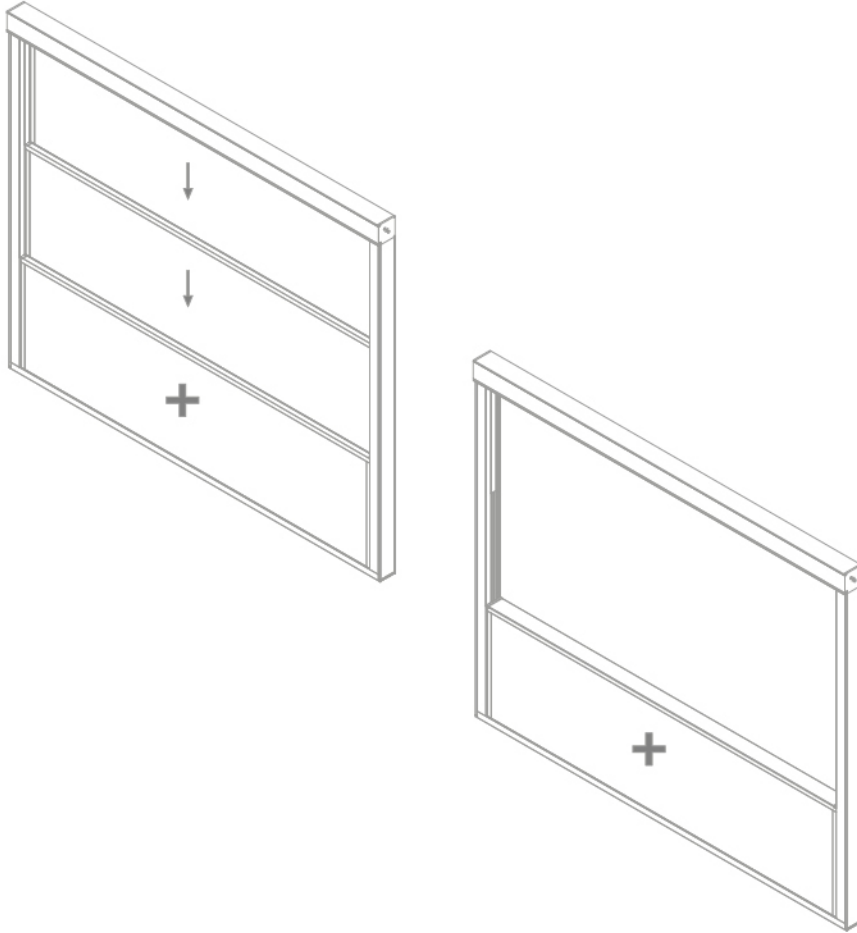

KLASİK GİYOTİN SİSTEM	KLASİK GİYOTİN SİSTEM	V.GY.	V.GY.	201
	<ul style="list-style-type: none">✓ Zincirli ve Kayışlı Mekanizma Alternatifi✓ Cam Özelliği; 8 mm, 10 mm tek cam ve 20 mm ısıcam✓ Max. En : 350 cm / Boy: 300 cm		SİSTEM	PR NO

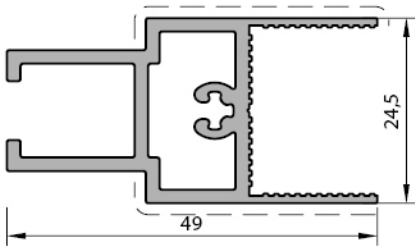
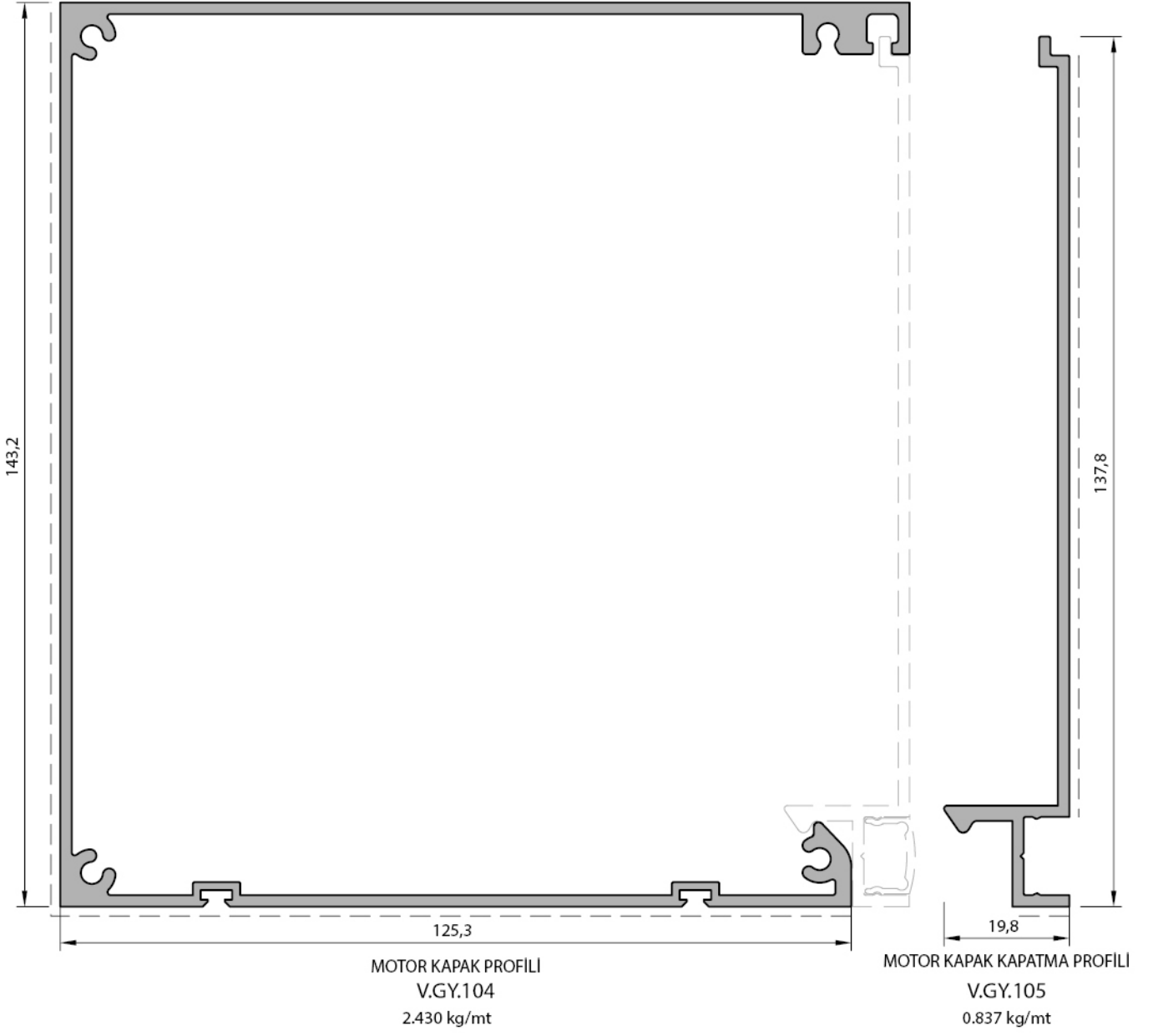

DIKEY BAZA PROFİLİ
V.GY.103
0.706 kg/mt

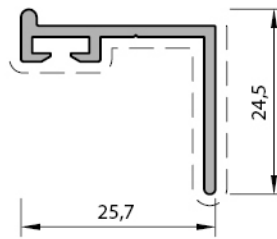

DAMLALIK PROFİLİ
V.GY.111
0.237 kg/mt

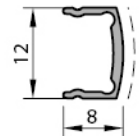

MOTOR KAPAK PROFİLİ
2458
0.065 kg/mt

* Profil ağırlıkları teoriktir. Ağırlık olarak teslimde yapılan tartım geçerlidir.

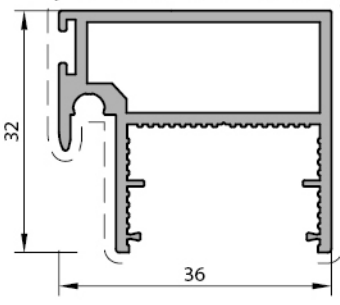

KENET PROFILI
V.ES.109
0.606 kg/mt

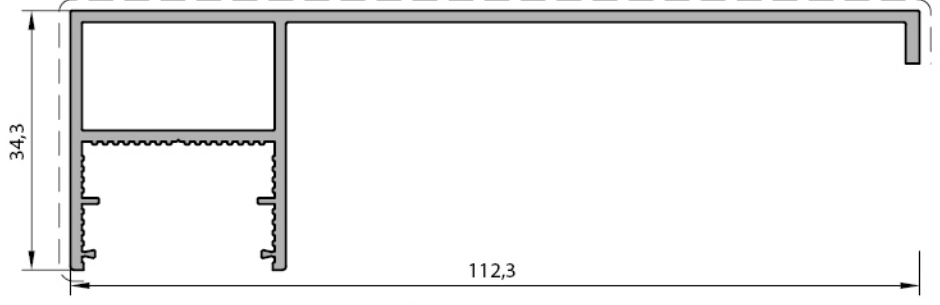

SABIT KÜPEŞTE PROFİL
V.GY.108
0.880 kg/mt

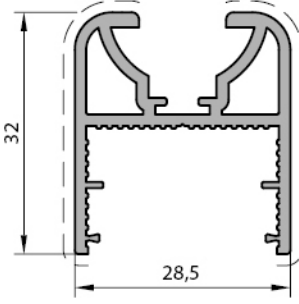

KÜPEŞTE BAZA PROFİL
V.GY.207
0.575 kg/mt

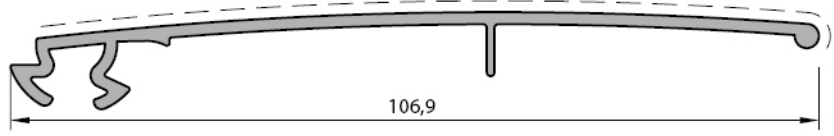

HAREKETLİ KÜPEŞTE PROFİL
V.GY.208
0.573 kg/mt

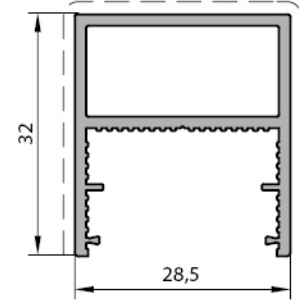

ALT BAZA PROFİL
V.GY.107
0.494 kg/mt

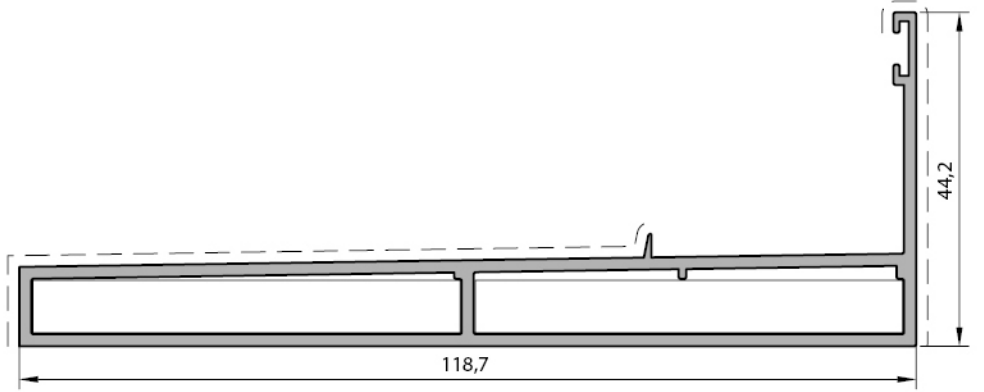

ALT KASA PROFİL
V.GY.106
1.295 kg/mt

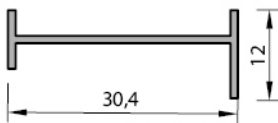

KENET DESTEK PROFİL
V.ES.112
0.130 kg/mt

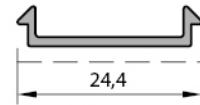

YAN KAPAMA PROFİL
V.GY.110
0.100 kg/mt

* Profil ağırlıkları teoriktir. Ağırlık olarak teslimde yapılan tartım geçerlidir.

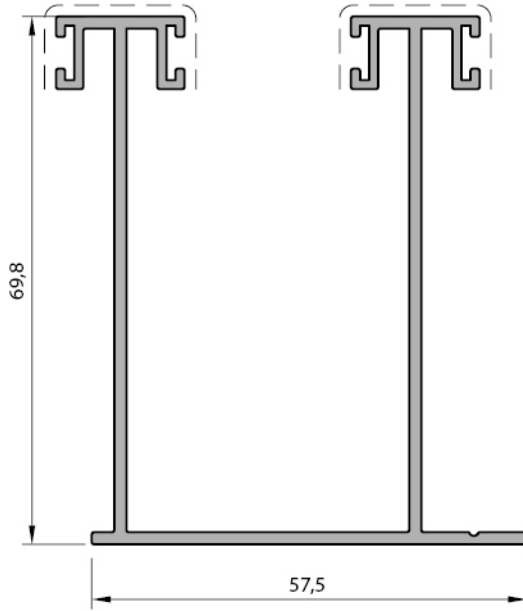

ORTA DİKME PROFILI
V.GY.102
1.136 kg/mt

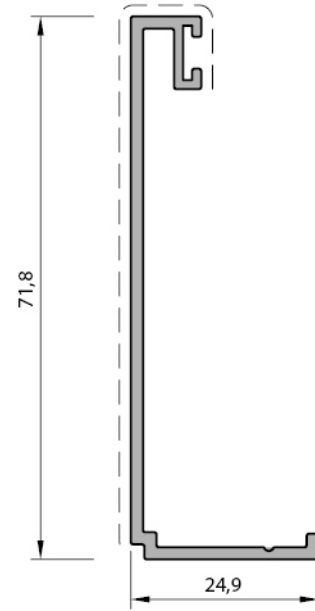

BİTİŞ DİKME PROFILI
V.GY.100
0.492 kg/mt

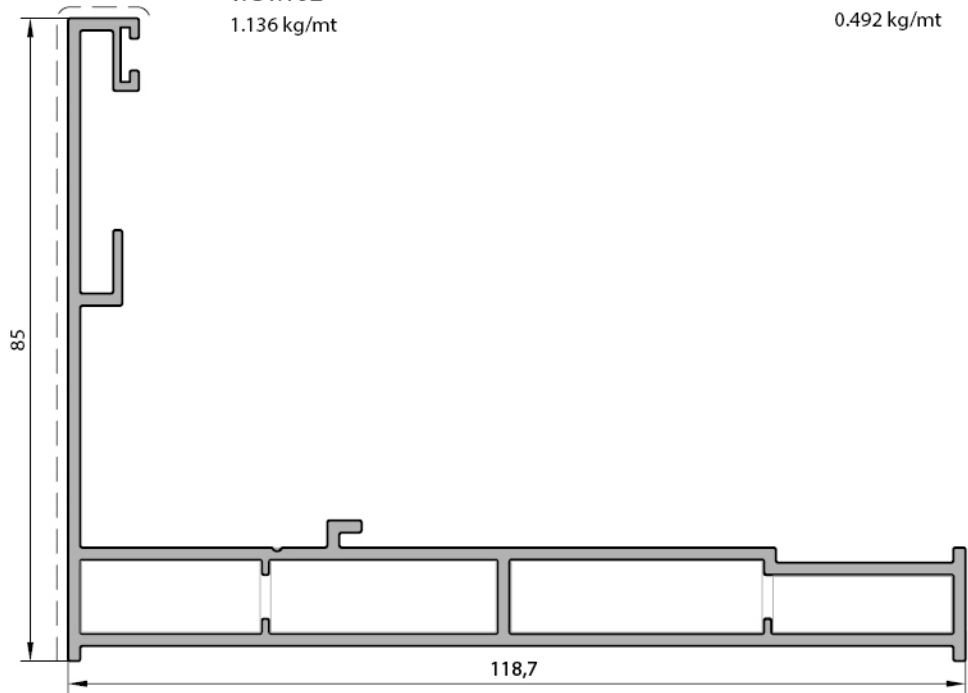

ANA DİKME PROFILI
V.GY.101
1.650 kg/mt

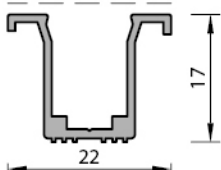

10 MM CAM ÇİTA PROFİL
V.ES.103
0.174 kg/mt

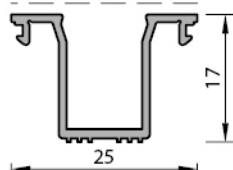

10 MM CAM ÇİTA PROFİL
V.ES.104
0.176 kg/mt

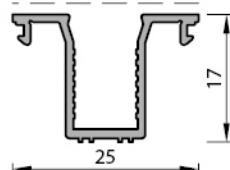



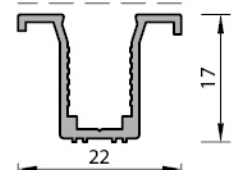





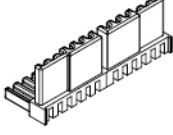
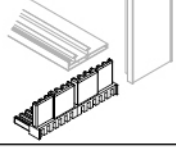

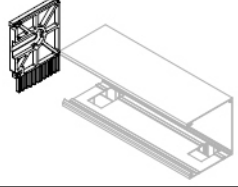

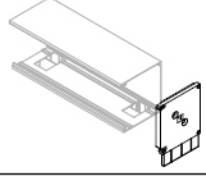

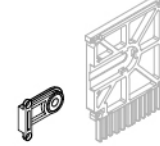
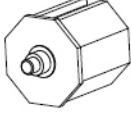
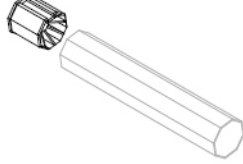

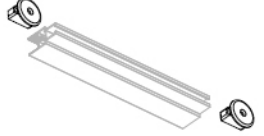
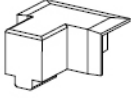
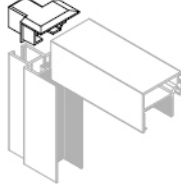

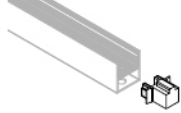
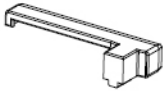

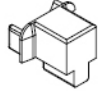
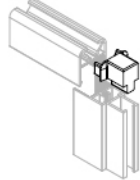

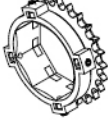
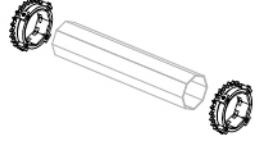
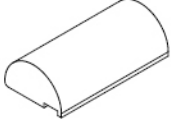
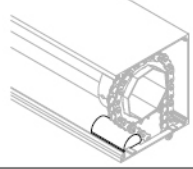



8 MM CAM ÇİTA PROFİL
V.ES.115
0.178 kg/mt

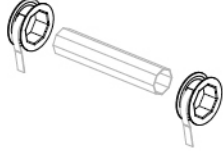

8 MM CAM ÇİTA PROFİL
V.ES.116
0.169 kg/mt

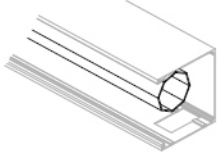
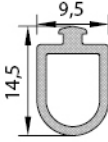
* Profil ağırlıkları teoriktir. Ağırlık olarak teslimde yapılan tartım geçerlidir.

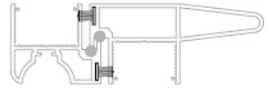
KOD	ŞEKİL	TANIM	PAKET METRAJİ	KULLANIM YERİ
GY-01		Kasa Köşe Birleştirme Takoğu	2	
GY-02		Motor Tarafı Kapak	1	
GY-03		Boru Başı Kapak	1	
GY-04		Rulman Yatağı	1	
GY-05		Boru Başı Alüminyum	1	
GY-07		Merkezleme Takoğu	8	
GY-08		Kenetli Baza Kapak	2L+2R	
GY-9		Düz Baza Kapak	2	
GY-10		Küpeşte Kapak	1L+1R	
GY-24		Küpeşte Takoğu	2	

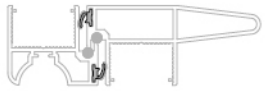
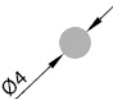
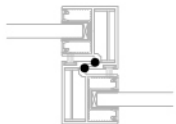
KOD	ŞEKİL	TANIM	PAKET METRAJİ	KULLANIM YERİ
GY-11		Zincir Dişlisi	2	
GY-13		Zincir Yönlendirici	2	
GY-14		Zincir 2,5 m	2	
GY-15		Zincir ve Kayış Tutucu	2	
GY-16		Kayış Kasmağı	2	
GY-17		Kayış 2,5 m	2	
GY-18		Motor Borusu	1	
Z-94		Epdm Kapak Baskı Fitili	65 gr/m 153 m	
LS55520		Fırça Fitol	400 m/pk	
ZF-1		Flock Fitol	200 m/pk	
W55.511		Epdm Kenet Fitili	16 gr/m 609 m	

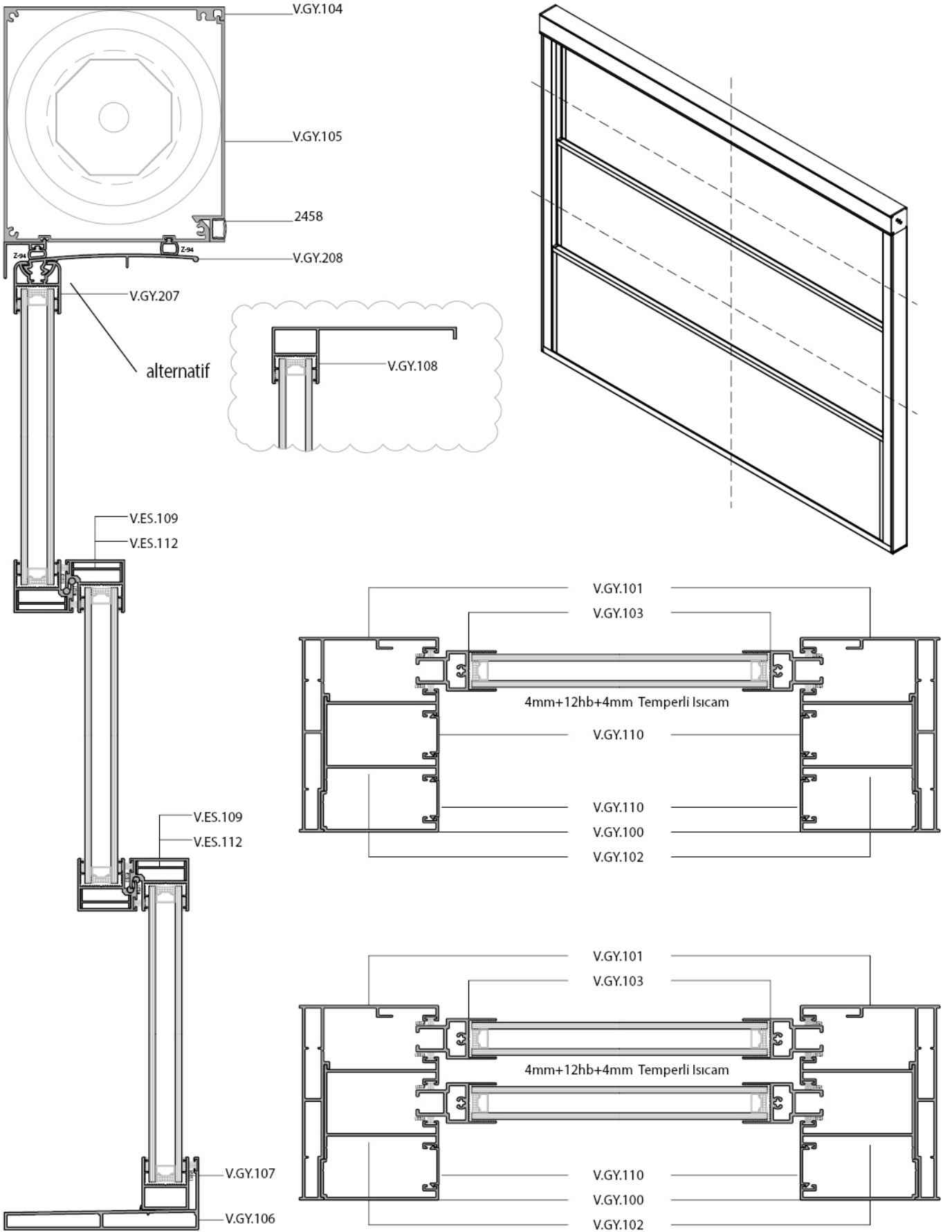

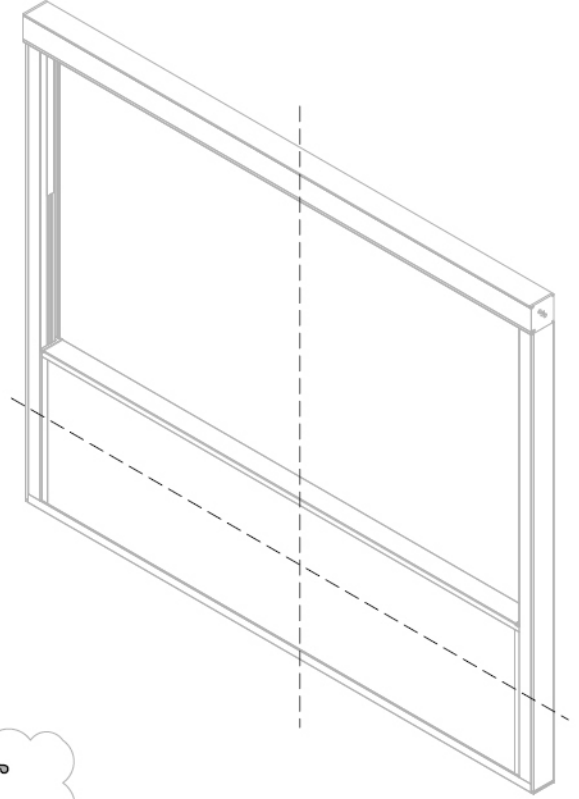
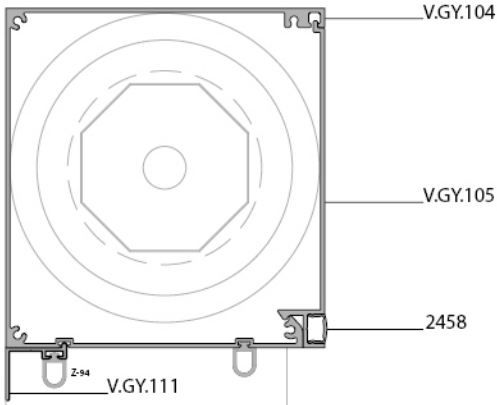

alternatif

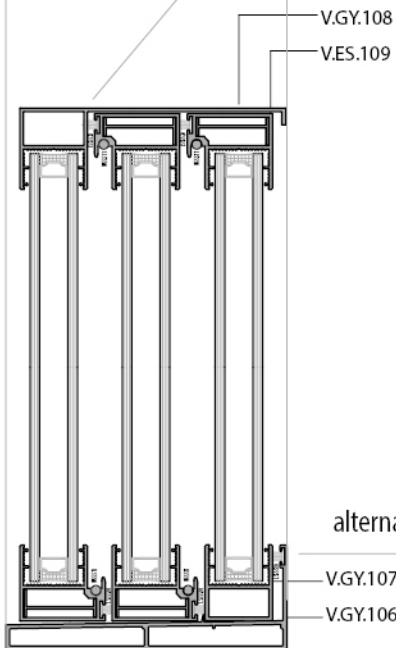
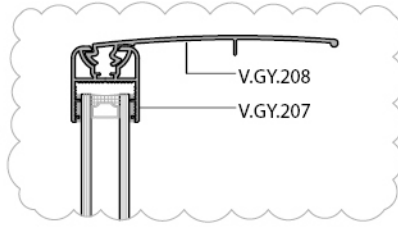

alternatif(flock fitil)

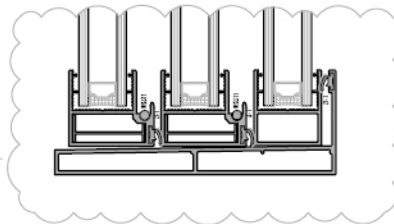
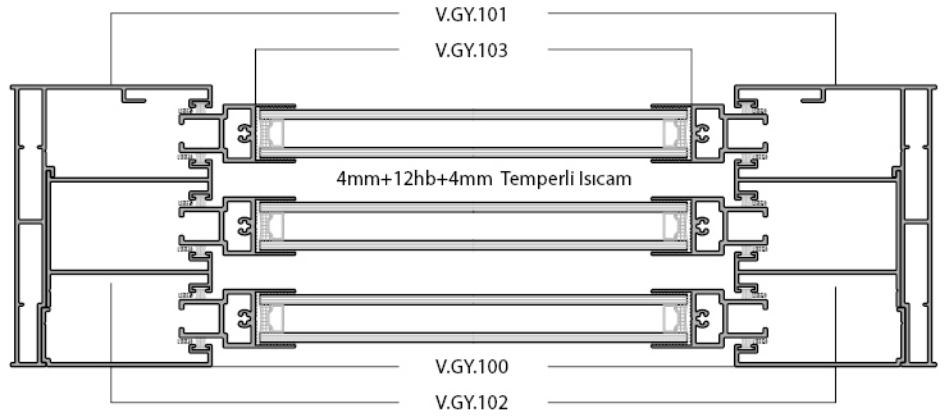

İÇ PANEL MONTAJ

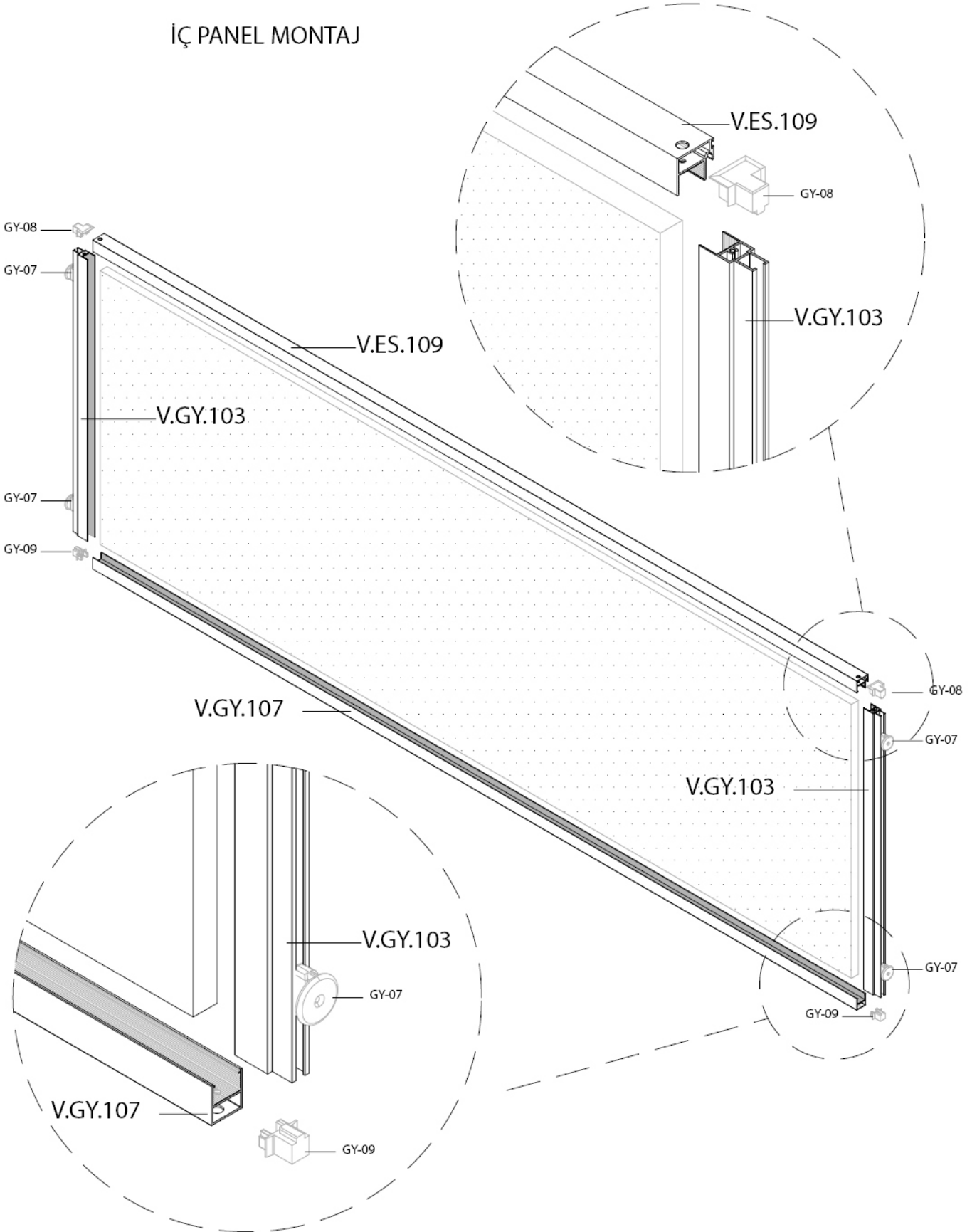

ORTA PANEL MONTAJ

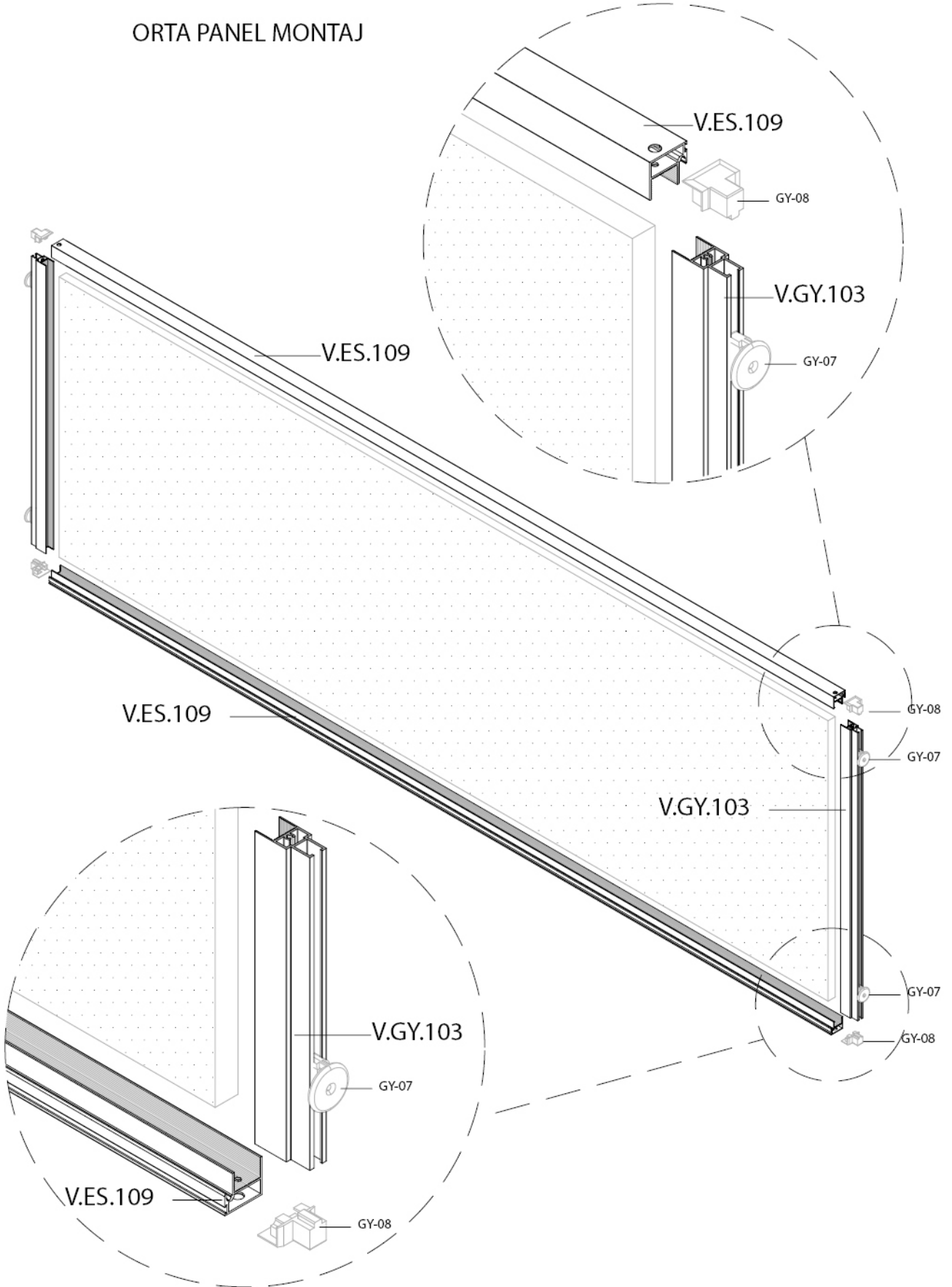

DIŞ PANEL MONTAJ

