

PANJUR PROFİLLERİ

SHOWER CABIN PROFILES

PROFİL KESİT DETAYLARI / PROFILE DETAIL DRAWINGS

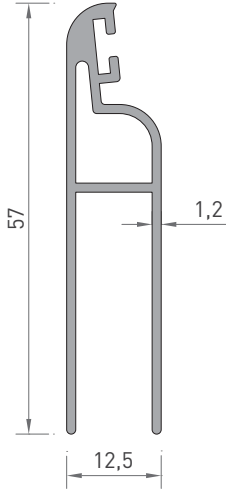
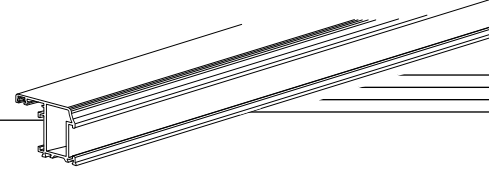

4741
PANJUR PROFİL
0.475 kg/mt

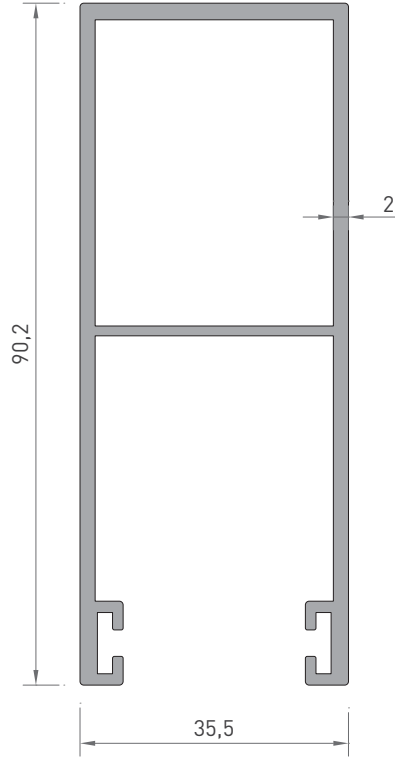

4489
YAN " U " PROFİL
1.395 kg/mt

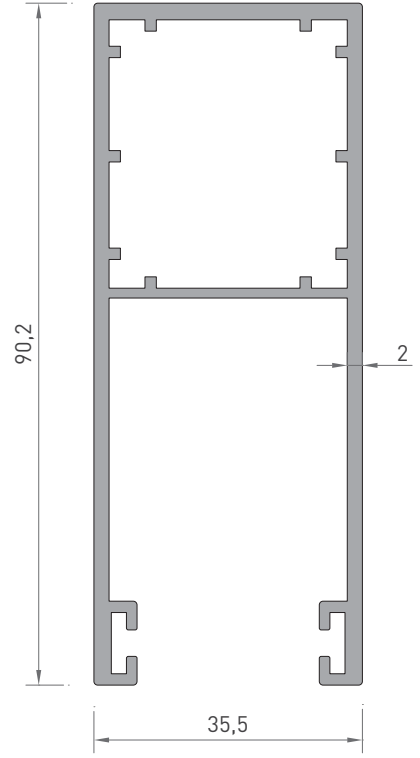

2216
YAN " U " PROFİL
1.445 kg/mt

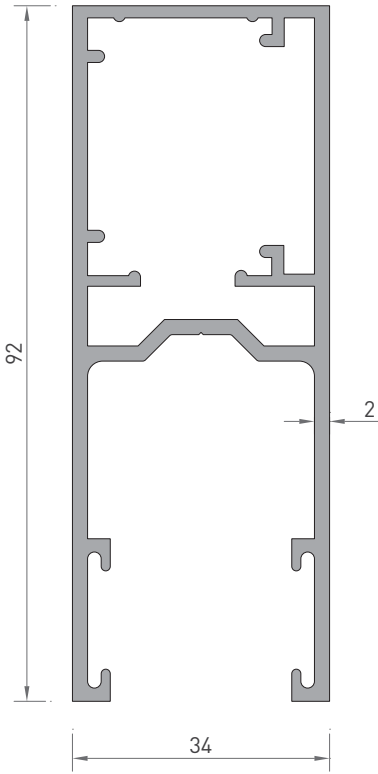

3094
YAN " U " PROFİL
1.540 kg/mt

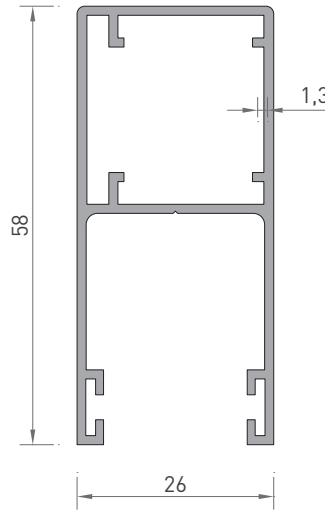

2872
YAN " U " PROFİL
0.640 kg/mt

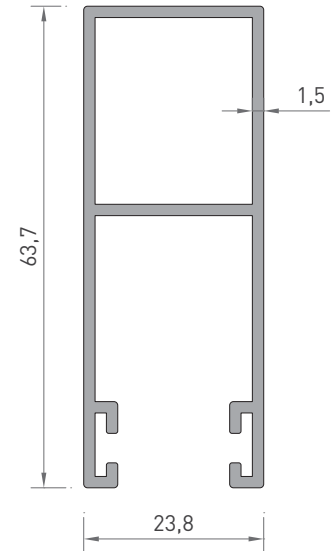

2215
YAN " U " PROFİL
0.770 kg/mt

* Belirtilen ağırlıklar Pres Profil için teorik kilogramlardır.
* Boyalı Profillerde ağırlığa % 5 ilave edilmesi gereklidir.

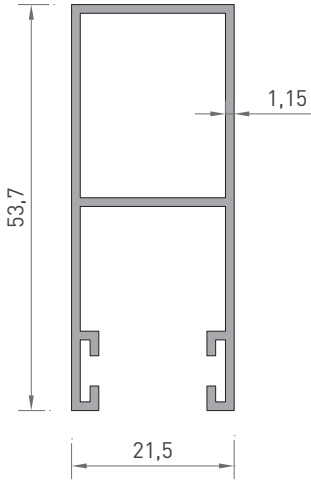

2850
YAN " U " PROFİL
0.510 kg/mt

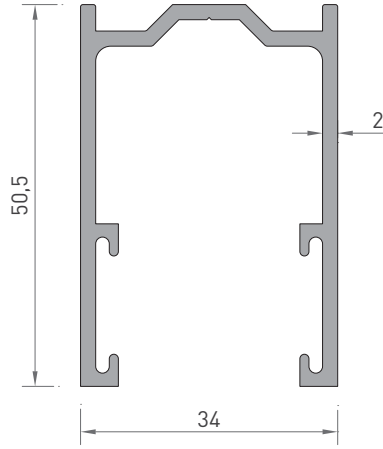

3093
YAN " U " PROFİL
0.820 kg/mt

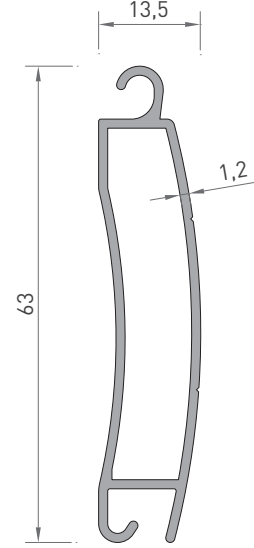

2212
PALET PROFİL
0.475 kg/mt

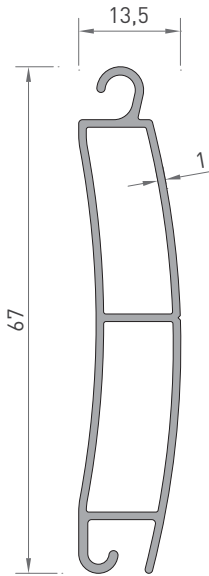

3088
PALET PROFİL
0.455 kg/mt

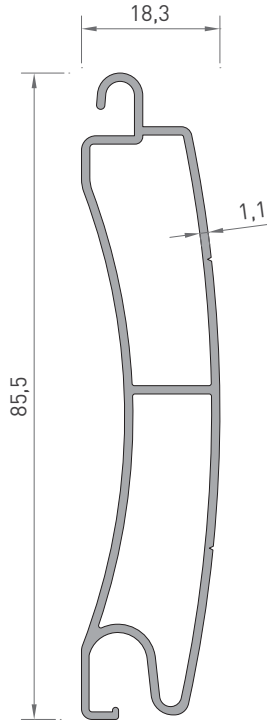

4488
PALET PROFİL
0.650 kg/mt

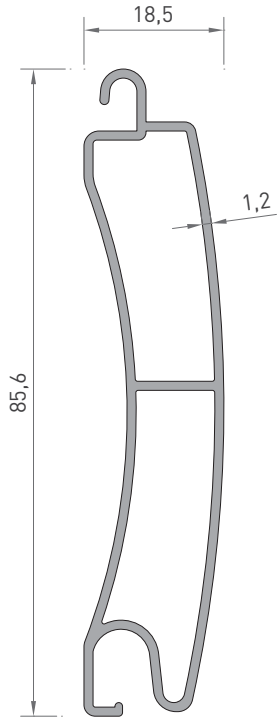

2213
PALET PROFİL
0.705 kg/mt

* Belirtilen ağırlıklar Pres Profil için teorik kilogramlardır.
* Boyalı Profillerde ağırlığa % 5 ilave edilmesi gereklidir.

PANJUR PROFİLLERİ

SHOWER CABIN PROFILES

PROFİL KESİT DETAYLARI / PROFILE DETAIL DRAWINGS

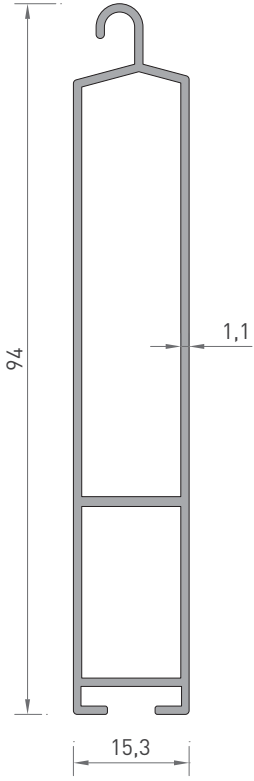
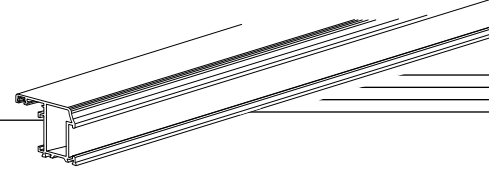

4493
ALT ETEK PROFİL
0.695 kg/mt

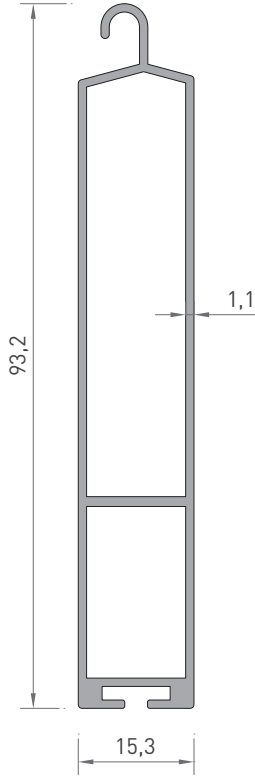

2214
ALT ETEK PROFİL
0.715 kg/mt

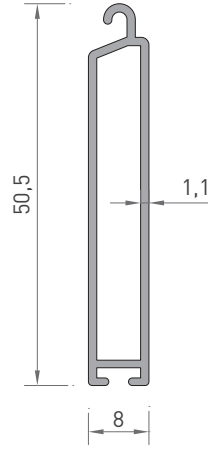

2849
ALT ETEK PROFİL
0.335 kg/mt

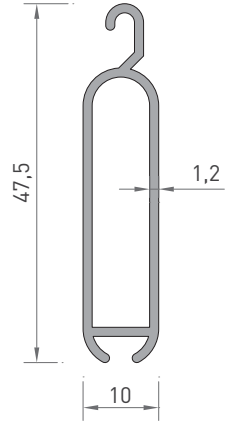

2217
FİTİLLİ ALT PARÇA
0.340 kg/mt

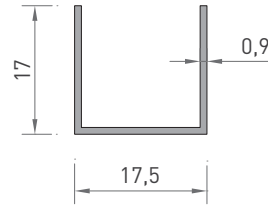

2221
DAR " U " PROFİL
0.120 kg/mt

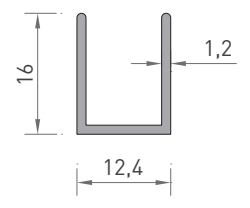

2222
TAVAN " U " PROFİL
0.135 kg/mt

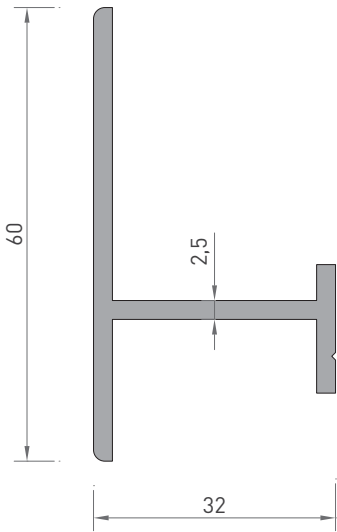

2063
PANJUR KASA
0.700 kg/mt

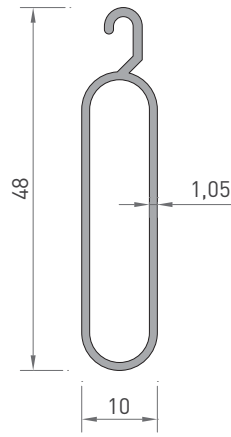

2218
ALT PARÇA
0.295 kg/mt

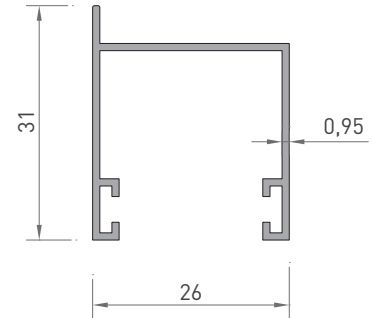

2219
FİTİLLİ " U " PROFİL
0.250 kg/mt

* Belirtilen ağırlıklar Pres Profil için teorik kilogramlardır.
* Boyalı Profillerde ağırlığa % 5 ilave edilmesi gereklidir.