

S
3
2

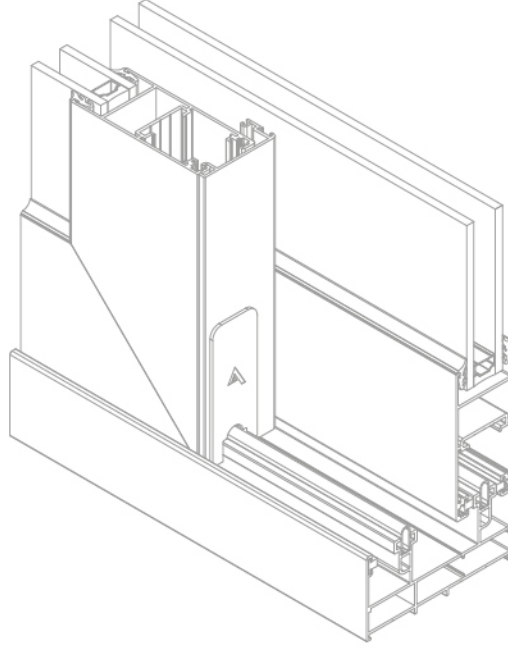

KLASİK SÜRME SİSTEM 100 KG SERİ (32) CLASSICAL SLIDING SYSTEM 100 KG SERIES (32)	S32	KASA	FRAME	100	S32 SİSTEM	100 GRUP PR NO
		ORTA KAYIT	MULLION	200		
		KANAT	SASH	300		
		ADAPTÖR, BAGL. PR	ADAPTER	400		
		EPDM GRUP	EPDM GROUP	500		
		PVC GRUP	PVC GROUP	600		
		AÇILIM GRUP	OPENING GROUP	700		
		YALITIM GRUP	INSULATED GROUP	800		

PROFİL ET KALINLIĞI	PROFILE THICKNESS	1.3-1,4 mm
KASA YÜKSEKLİĞİ	FRAME HEIGTH	46 mm
KANAT YÜKSEKLİĞİ	SASH HEIGTH	32 mm
CAM KALINLIĞI	GLASS THICKNESS	4-24 mm

ALAŞIM ÖZELLİKLERİ
ALLOY PROPERTIES

ÜRETİM VE MEKANİK STANDARTLAR
PRODUCTION AND MECANICAL STANDARDS

EN AW 6060 (AlMgSi0,5 F22)
EN AW 6063 (AlMg0,7Si F22)

EN 12020-2 EN 755-9 EN 755-2



Köşe takoz profili
Corner cleat profile



Köşe bağlantı
Corner connection



Köşe onbaşı
Corner cleat



Yatay sayfa
Page horizontal

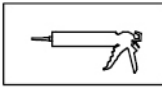

Silikon
Silicone



Dikkat
Attention

KLASİK SÜRME AÇILIM TİPLERİ CLASSICAL TYPES OF SLIDING OPENING

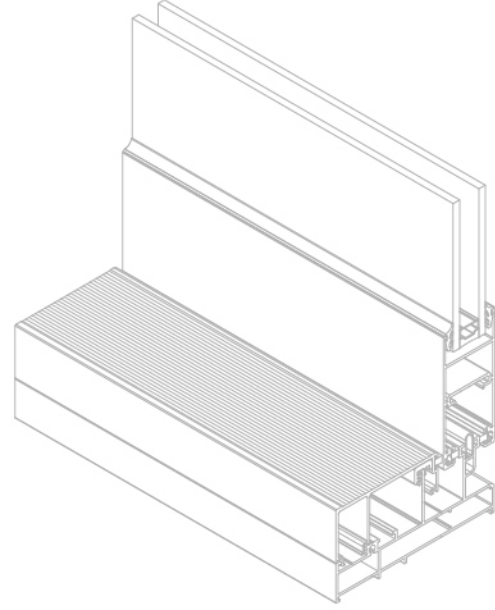

1 - ray 1 - rail



2 - ray 2 - rail



3 - ray 3 - rail

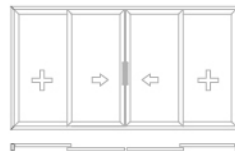
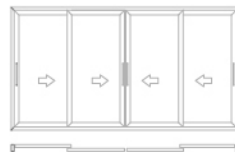
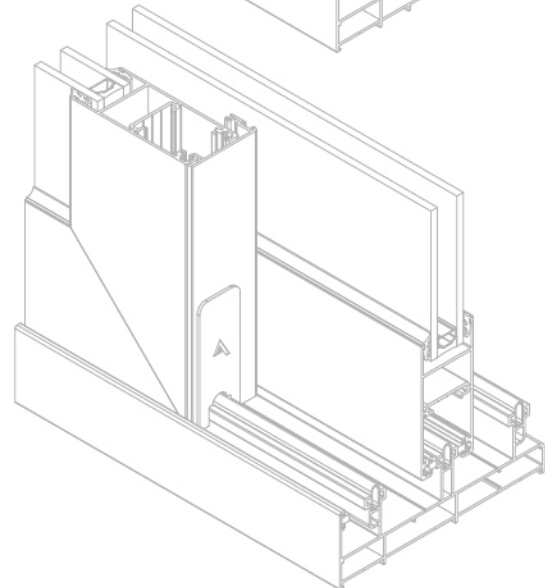
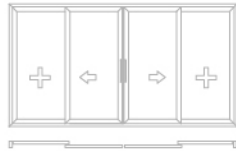
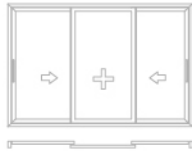
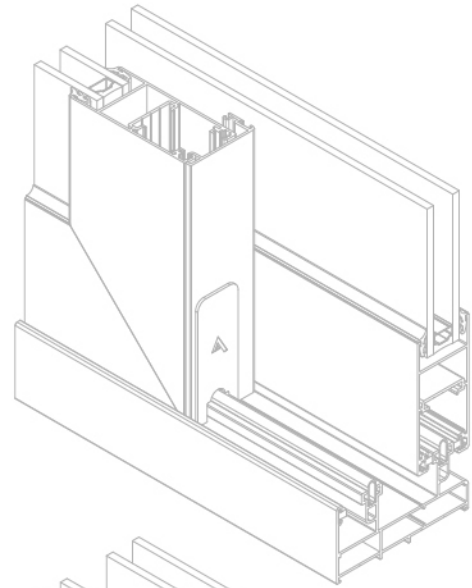
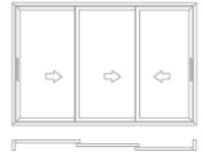

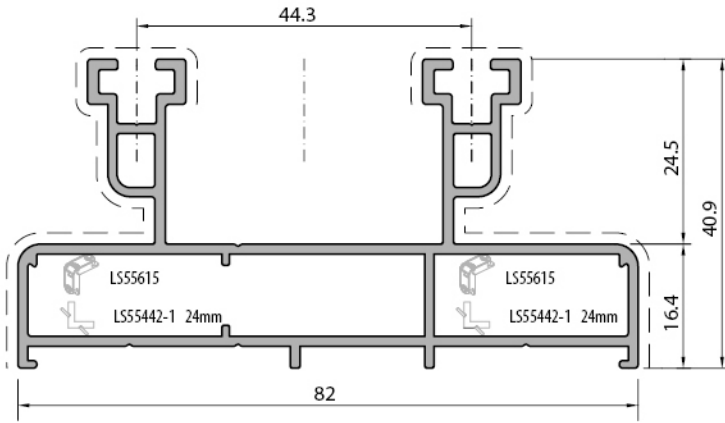
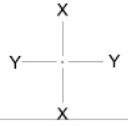

İki Raylı Profil Two rail profile	
S32101	
Weight :	1,185 kg/m
Ix :	26,59 cm ⁴
Iy :	6,63 cm ⁴
Wx :	6,36 cm ³
Wy :	2,78 cm ³

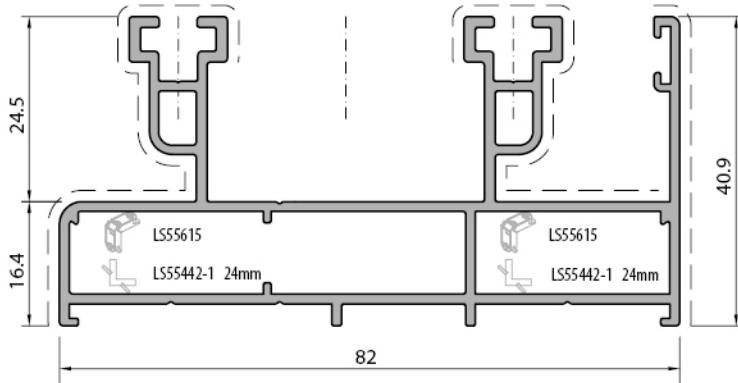

İki Raylı Profil Two rail profile	
S32102	
Weight :	1,298 kg/m
Ix :	32,71 cm ⁴
Iy :	7,40 cm ⁴
Wx :	7,50 cm ³
Wy :	3,28 cm ³

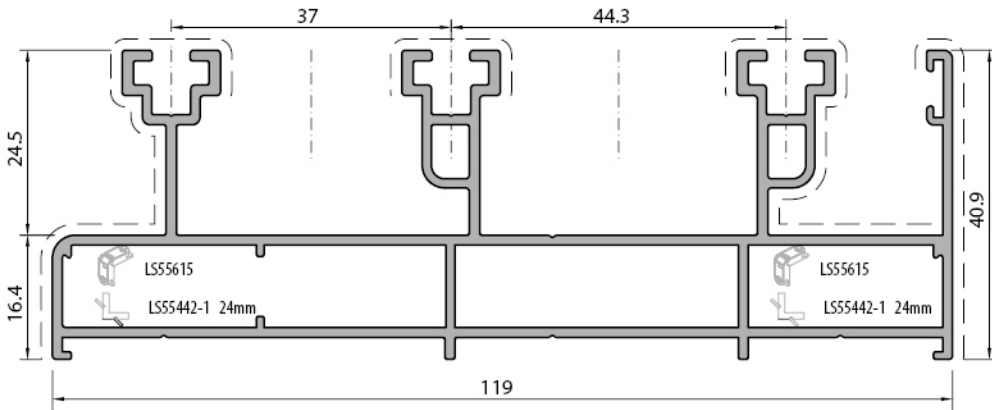

İki Raylı Sineklik Profil Two rail fly screen profile	
S32103	
Weight :	1,774 kg/m
Ix :	89,55 cm ⁴
Iy :	10,22 cm ⁴
Wx :	14,22 cm ³
Wy :	4,53 cm ³

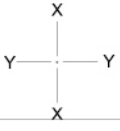

S32 KLASİK SÜRME SİSTEMİ / CLASSICAL SLIDE SYSTEM

ÜRÜN TEKNİK ÖZELLİKLERİ / PRODUCT TECHNICAL FEATURES

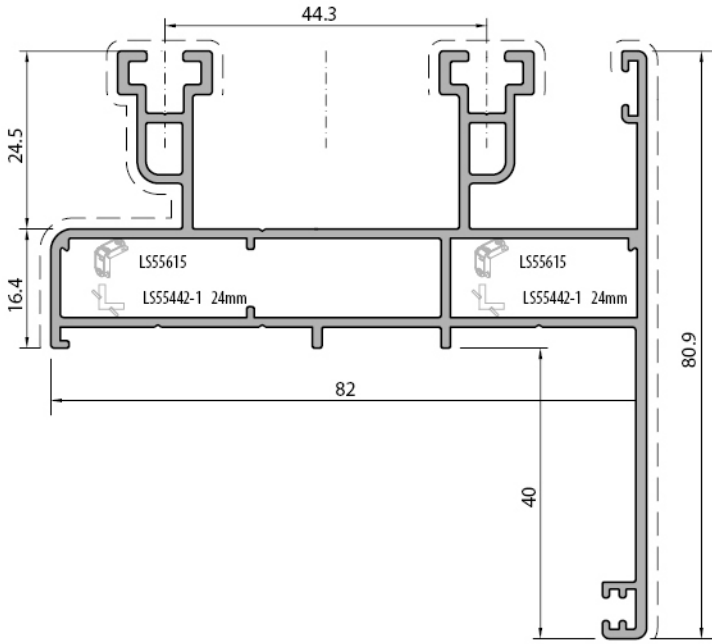

İki Raylı Profil Two rail profile
S32104
Weight : 1,497 kg/m
lx : 44,63 cm ⁴
ly : 16,41 cm ⁴
Wx : 9,19 cm ³
Wy : 5,85 cm ³

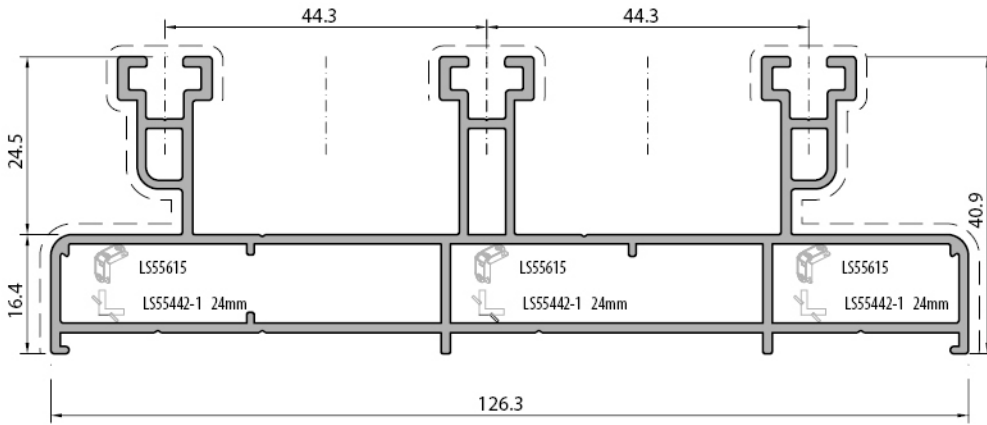

Üç Raylı Profil Three rail profile
S32105
Weight : 1,765 kg/m
lx : 93,52 cm ⁴
ly : 9,77 cm ⁴
Wx : 14,67 cm ³
Wy : 1,80 cm ³

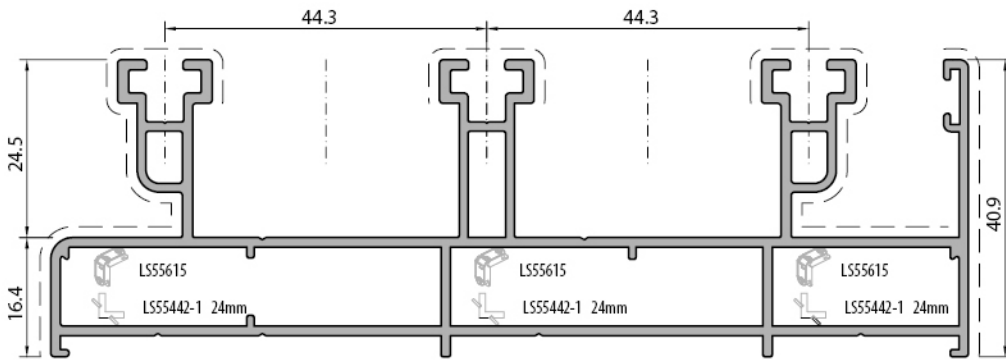

Üç Raylı Profil Three rail profile
S32106
Weight : 1,873 kg/m
lx : 108,30 cm ⁴
ly : 10,52 cm ⁴
Wx : 16,36 cm ³
Wy : 4,64 cm ³

Profil değerleri teoriktir. Ağırlık olarak teslimde yapılan tartım geçerlidir. Profil imalatları TS EN 12020-02 ve TS EN 755-9 toleransı, Moment değerleri EN 14024'e göre hesaplanmıştır.
Profile values are theoretical pre-shipment weight will be valid. The tolerances of Profile manufacturing are calculated according to EN 12020-2 and TS EN 755-9; moment values are calculated according to EN 14024.

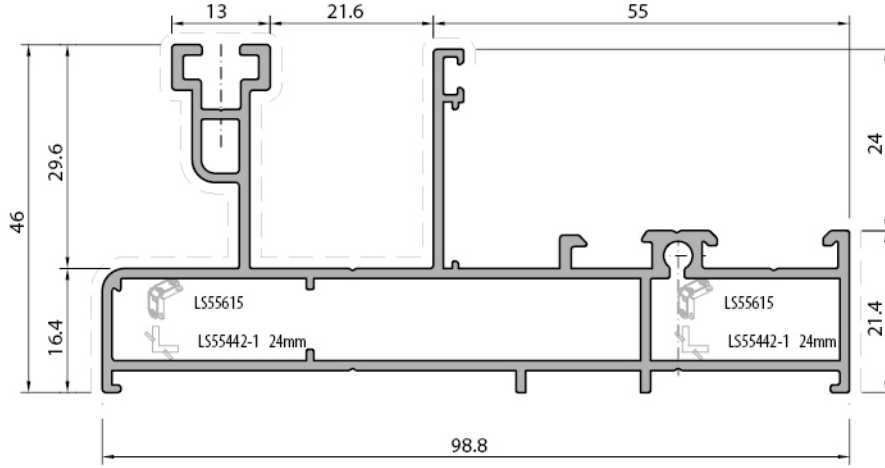

Tek Raylı Profil-Sabit <i>Mono rail profile-fix</i>	
S32107	
Weight :	1,346 kg/m
Ix :	45,69 cm ⁴
Iy :	7,11 cm ⁴
Wx :	8,70 cm ³
Wy :	2,44 cm ³

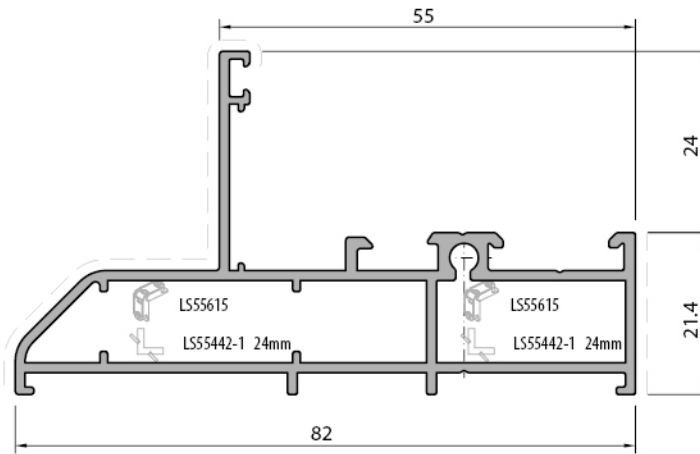

Pencere Geçit Profili <i>Window adapter profile</i>	
S32108	
Weight :	0,973 kg/m
Ix :	20,42 cm ⁴
Iy :	3,64 cm ⁴
Wx :	4,73 cm ³
Wy :	1,13 cm ³

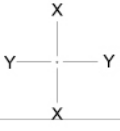

S32 KLASİK SÜRME SİSTEM / CLASSICAL SLIDE SYSTEM

ÜRÜN TEKNİK ÖZELLİKLERİ / PRODUCT TECHNICAL FEATURES

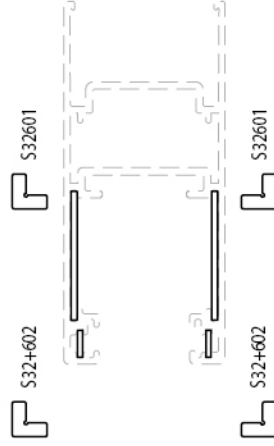
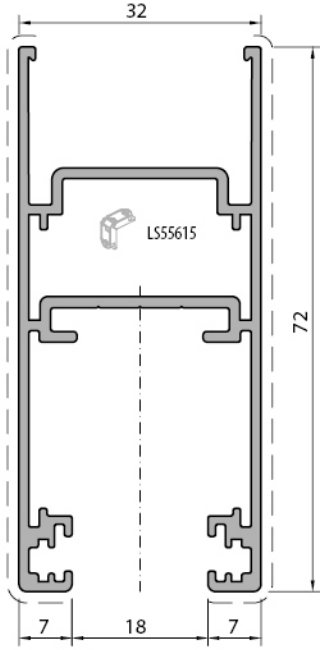

Kanat Profili Sash profile	
S32301	
Weight :	0,985 kg/m
Ix :	6,30 cm ⁴
Iy :	15,00 cm ⁴
Wx :	3,93 cm ³
Wy :	4,00 cm ³

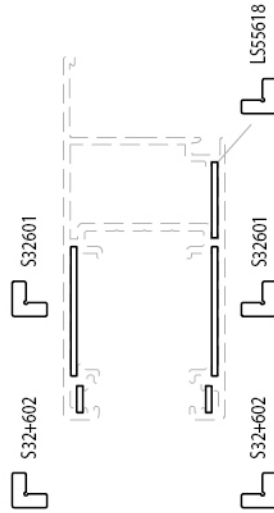
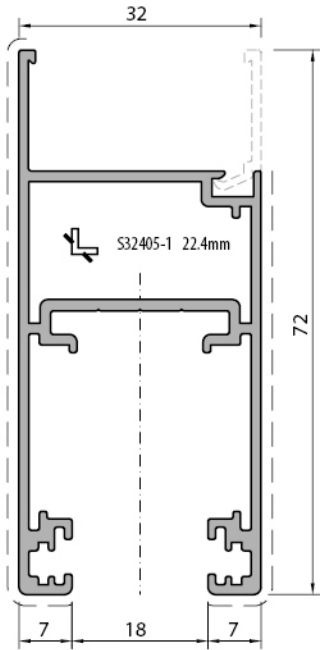

Kanat Profili Sash profile	
S32302	
Weight :	0,901 kg/m
Ix :	5,49 cm ⁴
Iy :	12,77 cm ⁴
Wx :	3,26 cm ³
Wy :	3,20 cm ³

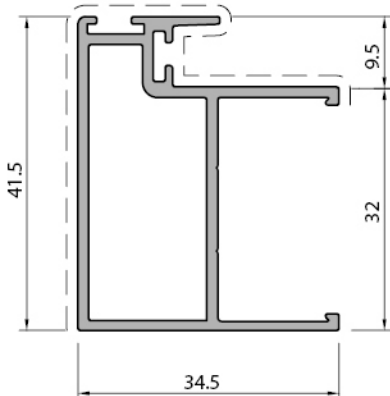

Kanat Profili Sash profile	
S32303	
Weight :	0,606 kg/m
Ix :	4,80 cm ⁴
Iy :	2,09 cm ⁴
Wx :	2,28 cm ³
Wy :	0,96 cm ³

Profil değerleri teoriktir. Ağırlık olarak teslimde yapılan tartım geçerlidir. Profil imalatları TS EN 12020-02 ve TS EN 755-9 toleransı, Moment değerleri EN 14024'e göre hesaplanmıştır.
Profile values are theoretical pre-shipment weight will be valid. The tolerances of Profile manufacturing are calculated according to EN 12020-2 and TS EN 755-9; moment values are calculated according to EN 14024.

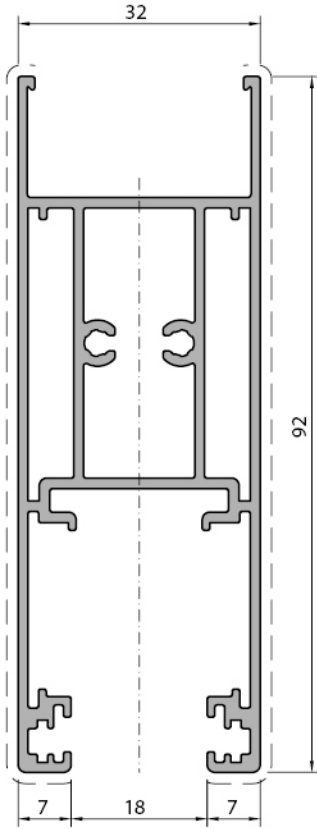

Baza Kanat Profili <i>Bottom sash profile</i>	
S32304	
Weight :	1,383 kg/m
Ix :	8,802 cm ⁴
Iy :	32,55 cm ⁴
Wx :	5,01 cm ³
Wy :	7,502 cm ³

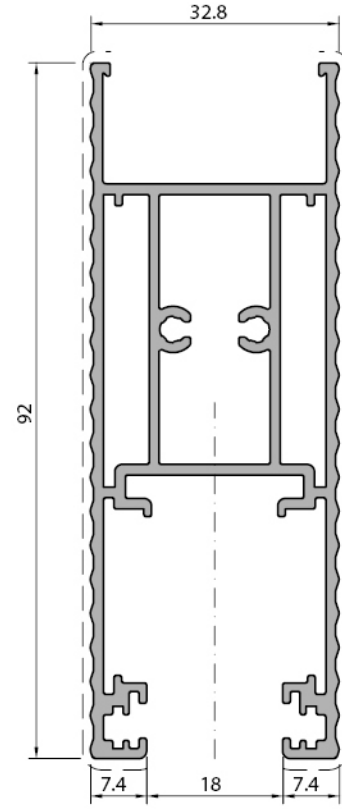

Baza Kanat Profili <i>Bottom sash profile</i>	
S32305	
Weight :	1,487 kg/m
Ix :	8,84 cm ⁴
Iy :	34,89 cm ⁴
Wx :	5,37 cm ³
Wy :	7,53 cm ³

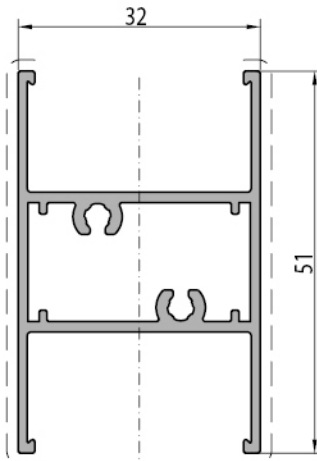

Kanat Orta Kayıt Profili <i>Sash mullion profile</i>	
S32306	
Weight :	1,487 kg/m
Ix :	3,92 cm ⁴
Iy :	3,66 cm ⁴
Wx :	2,45 cm ³
Wy :	1,45 cm ³

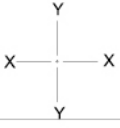

S32 KLASİK SÜRME SİSTEM / CLASSICAL SLIDE SYSTEM

ÜRÜN TEKNİK ÖZELLİKLERİ / PRODUCT TECHNICAL FEATURES

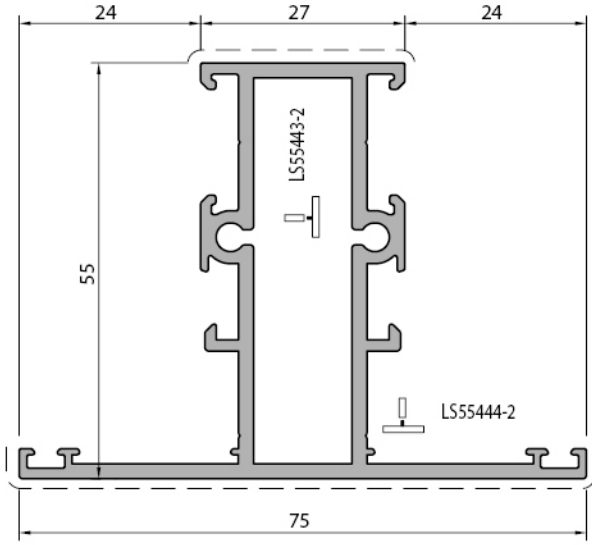

Orta Kayıt Profili <i>Mullion profile</i>
S32201
Weight : 1,298 kg/m
lx : 18,06 cm ⁴
ly : 10,16 cm ⁴
Wx : 5,47 cm ³
Wy : 2,70 cm ³

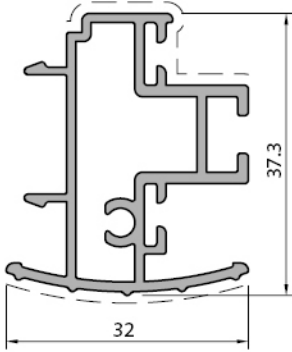
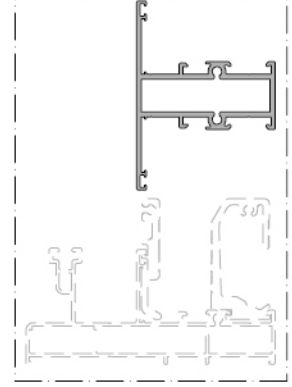

Kanat Adaptör Profili <i>Sash adapter profile</i>
S32401
Weight : 0,623 kg/m

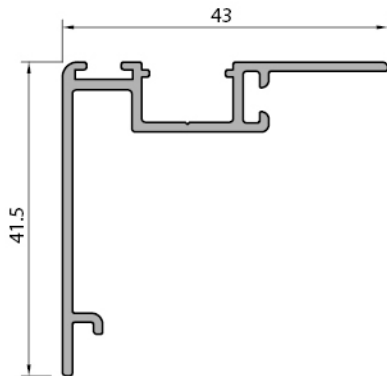
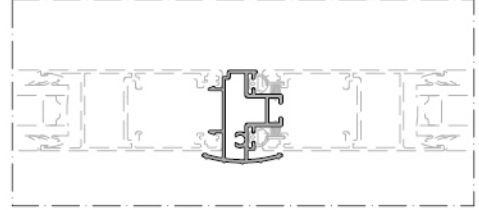

Kenet Profili <i>Clamp profile</i>
S32402
Weight : 0,395 kg/m

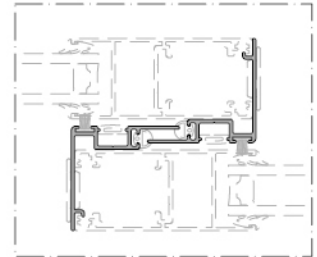

Profil değerleri teoriktir. Ağırlık olarak teslimde yapılan tartım geçerlidir. Profil imalatları TS EN 12020-02 ve TS EN 755-9 toleransı, Moment değerleri EN 14024'e göre hesaplanmıştır.
Profile values are theoretical pre-shipment weight will be valid. The tolerances of Profile manufacturing are calculated according to EN 12020-2 and TS EN 755-9; moment values are calculated according to EN 14024.

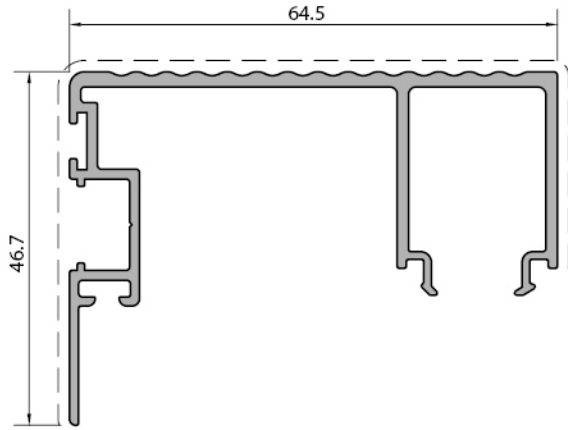

Kenet Profili Clamp profile
S32403
Weight : 0,802 kg/m

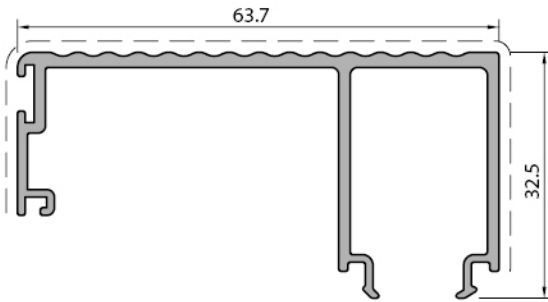
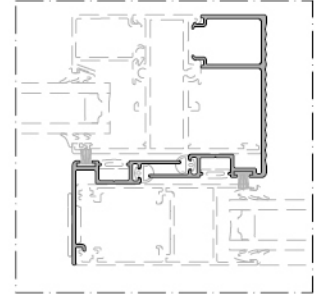

Kenet Profili Clamp profile
S32+402
Weight : 0,669 kg/m

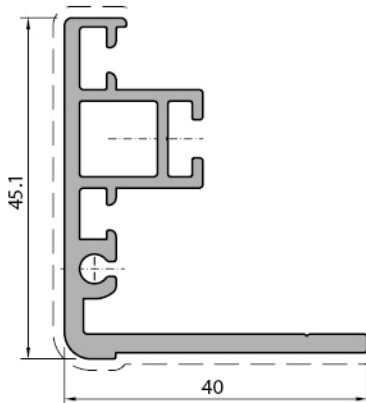
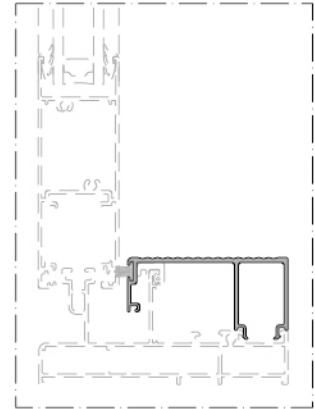

Sabit Kanat Kenet Profili Fixed sash clamp profile
S32+403
Weight : 0,805 kg/m

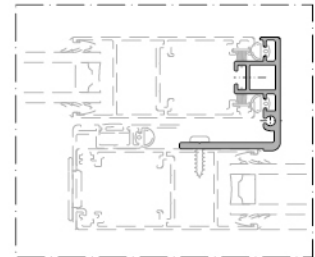

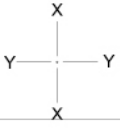

S32 KLASİK SÜRME SİSTEM / CLASSICAL SLIDE SYSTEM

ÜRÜN TEKNİK ÖZELLİKLERİ / PRODUCT TECHNICAL FEATURES

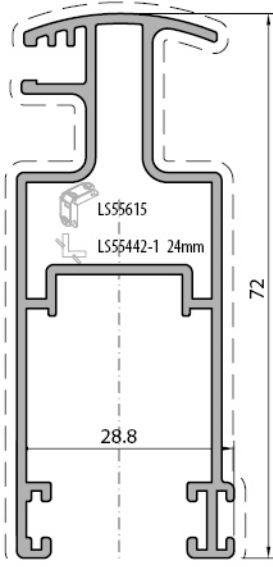

Sineklik Kanat Profili
flyscreen sash profile

LS55401

Weight : 0,894 kg/m

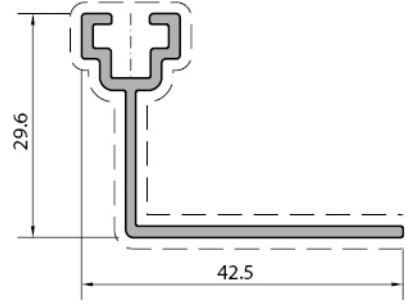
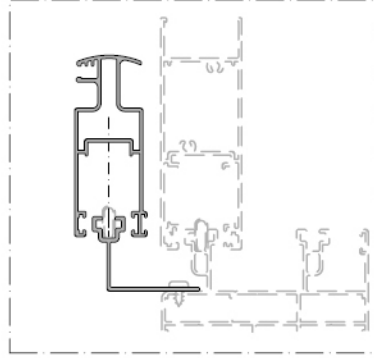

Sineklik Ray Profili
Flyscreen rail profile

S32+407

Weight : 0,338 kg/m

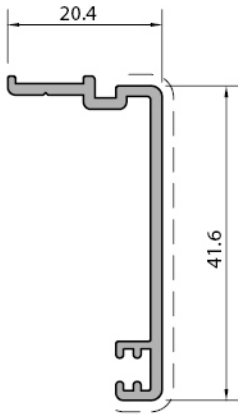

Pervaz Profili
Additional profile

S32+405

Weight : 0,300 kg/m

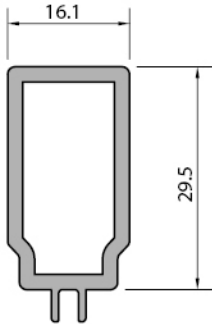
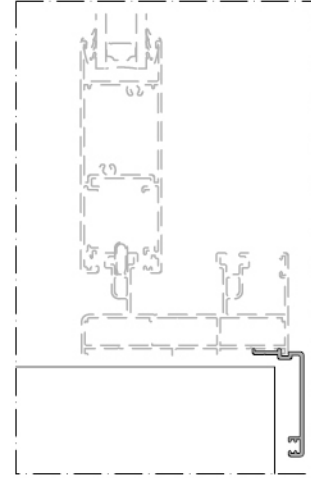

Kanat Sabitleme Profili
Sash fixing profile

S32+406

Weight : 0,456 kg/m

S32+406-1 100 mm

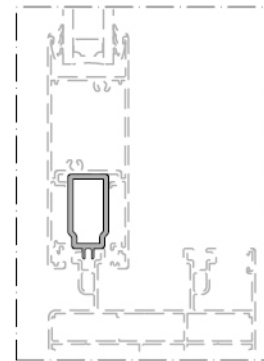

Profil değerleri teoriktir. Ağırlık olarak teslimde yapılan tartım geçerlidir. Profil imalatları TS EN 12020-02 ve TS EN 755-9 toleransı, Moment değerleri EN 14024'e göre hesaplanmıştır.
Profile values are theoretical pre-shipment weight will be valid. The tolerances of Profile manufacturing are calculated according to EN 12020-2 and TS EN 755-9; moment values are calculated according to EN 14024.

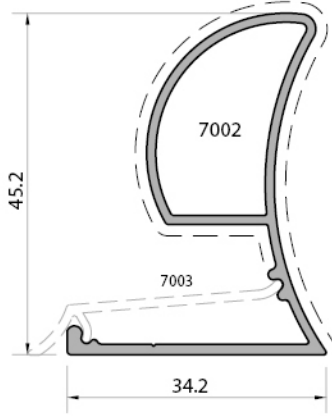
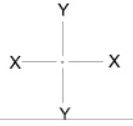

Kanat Takviye Profili Sash reinforcement profile	
LS55420	
Weight :	0,469 kg/m
Ix :	4,37 cm ⁴
Iy :	1,27 cm ⁴
Wx :	2,32 cm ³
Wy :	0,61 cm ³

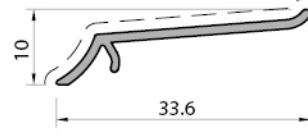

Kapak Profili Cover profile	
LS55421	
Weight :	0,129 kg/m

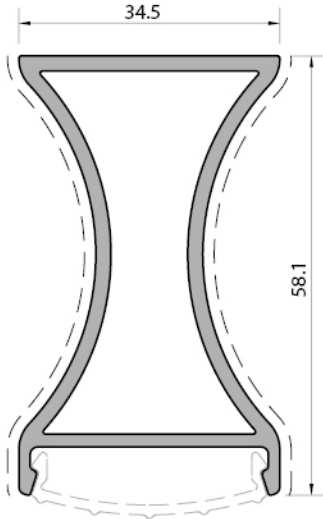
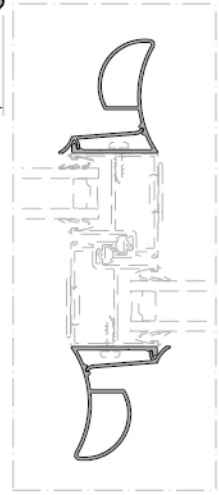

Kanat Takviye Profili Sash reinforcement profile	
LS55422	
Weight :	0,975 kg/m
Ix :	14,11 cm ⁴
Iy :	3,91 cm ⁴
Wx :	4,54 cm ³
Wy :	2,26 cm ³

Kanat Takviye Profili Sash reinforcement profile	
LS55423	
Weight :	0,821 kg/m
Ix :	6,45 cm ⁴
Iy :	3,39 cm ⁴
Wx :	2,62 cm ³
Wy :	1,96 cm ³

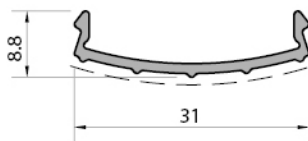
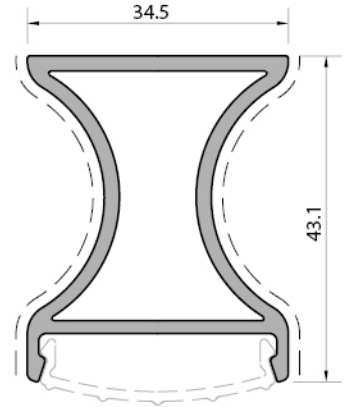

Kapak Profili Cover profile	
LS55424	
Weight :	0,148 kg/m

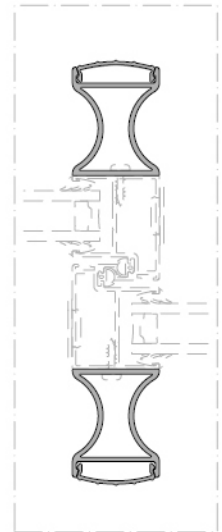

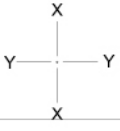

S32 KLASİK SÜRME SİSTEM / CLASSICAL SLIDE SYSTEM

ÜRÜN TEKNİK ÖZELLİKLERİ / PRODUCT TECHNICAL FEATURES

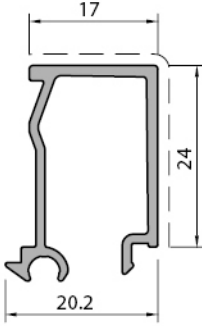

Cam Çıtası Profili Glazing bead profile
LS55432
Weight : 0,294 kg/m

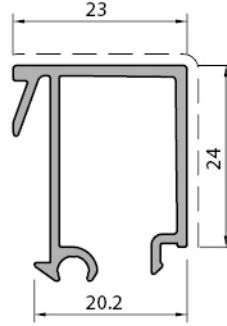

Cam Çıtası Profili Glazing bead profile
LS55433
Weight : 0,341 kg/m

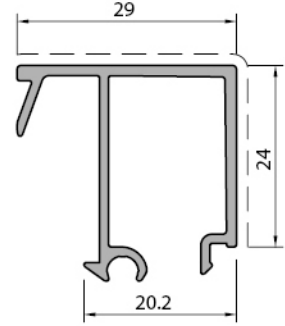

Cam Çıtası Profili Glazing bead profile
LS55434
Weight : 0,363 kg/m

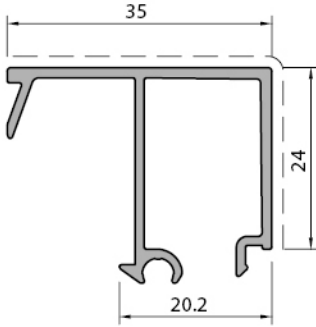

Cam Çıtası Profili Glazing bead profile
LS55435
Weight : 0,385 kg/m

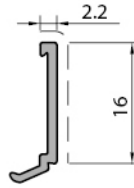

Cam Çıtası Profili Glazing bead profile
S32+411
Weight : 0,074 kg/m

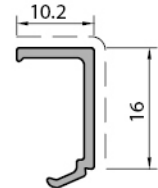

Cam Çıtası Profili Glazing bead profile
S32+412
Weight : 0,106 kg/m

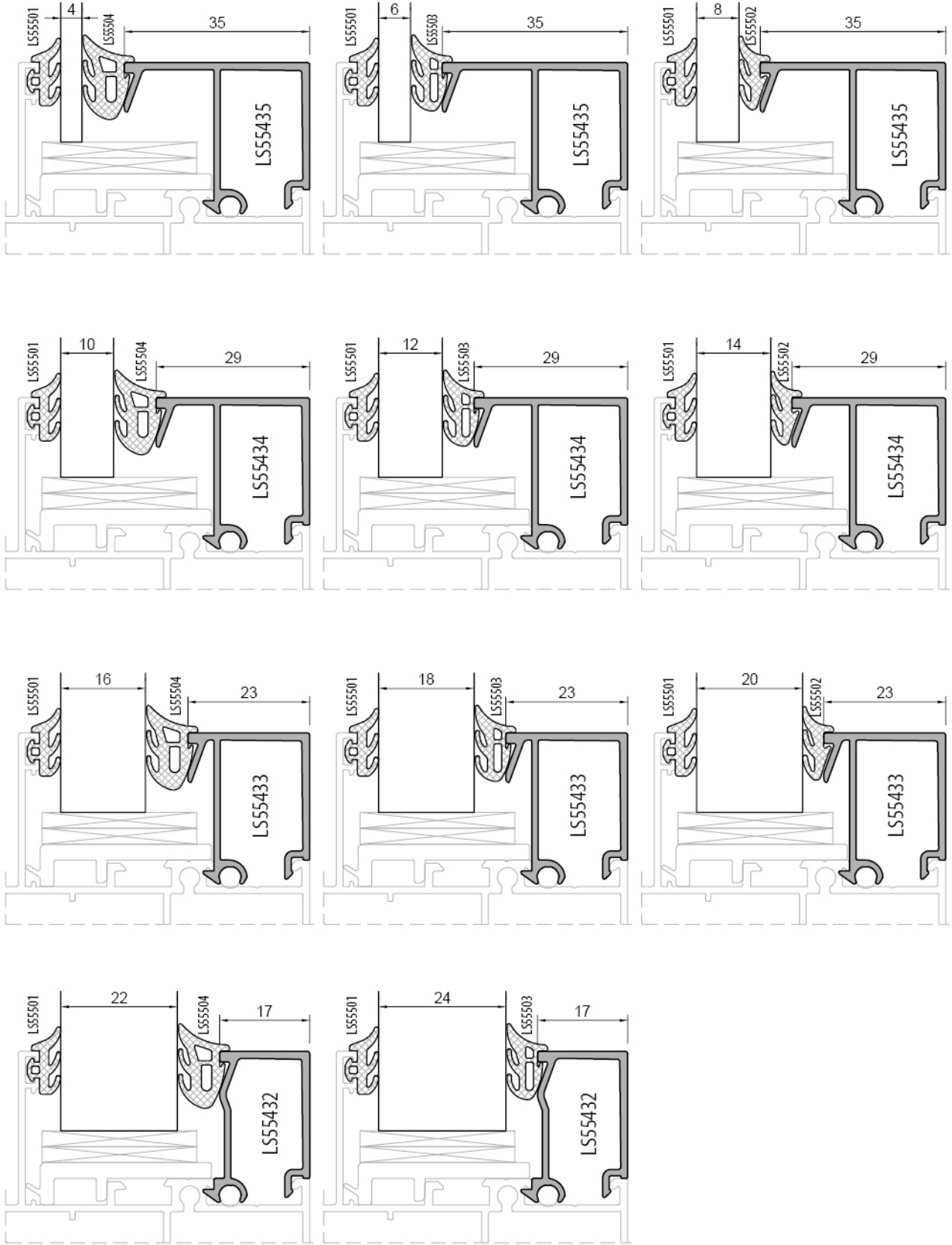

Profil değerleri teoriktir. Ağırlık olarak teslimde yapılan tartım geçerlidir. Profil imalatları TS EN 12020-02 ve TS EN 755-9 toleransı, Moment değerleri EN 14024'e göre hesaplanmıştır.
Profile values are theoretical pre-shipment weight will be valid. The tolerances of Profile manufacturing are calculated according to EN 12020-2 and TS EN 755-9; moment values are calculated according to EN 14024.

S32 KLASİK SÜRME SİSTEMİ / CLASSICAL SLIDE SYSTEM

ÜRÜN TEKNİK ÖZELLİKLERİ / PRODUCT TECHNICAL FEATURES

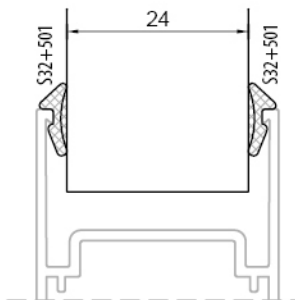
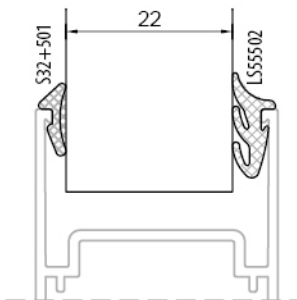
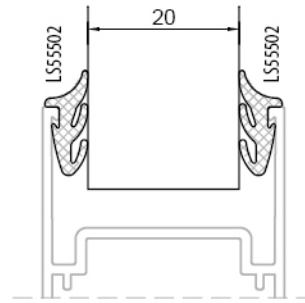
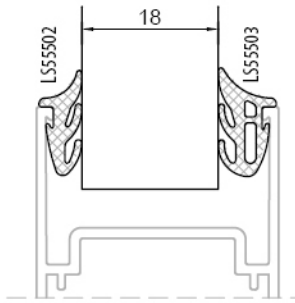
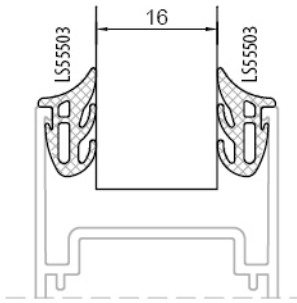
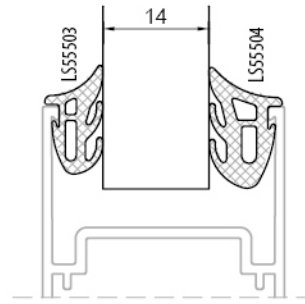
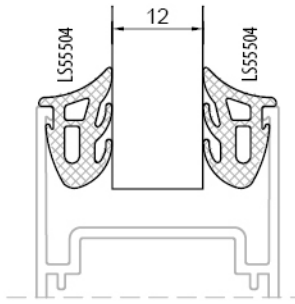
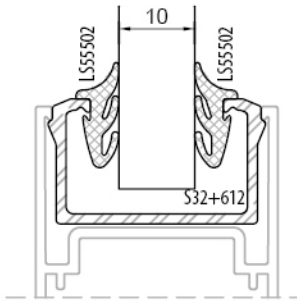
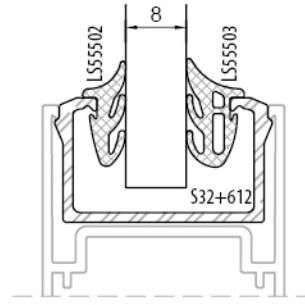
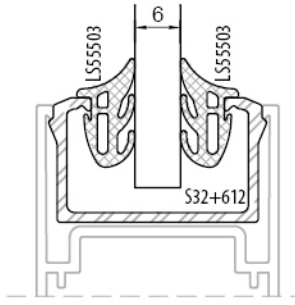
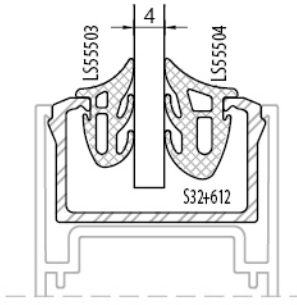

Profil değerleri teoriktir. Ağırlık olarak teslimde yapılan tartım geçerlidir. Profil imalatları TS EN 12020-02 ve TS EN 755-9 toleransı, Moment değerleri EN 14024'e göre hesaplanmıştır.
Profile values are theoretical pre-shipment weight will be valid. The tolerances of Profile manufacturing are calculated according to EN 12020-2 and TS EN 755-9; moment values are calculated according to EN 14024.

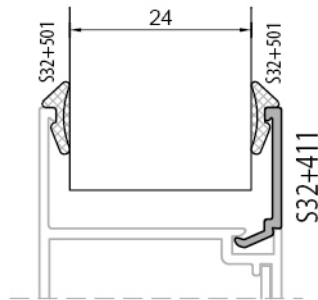
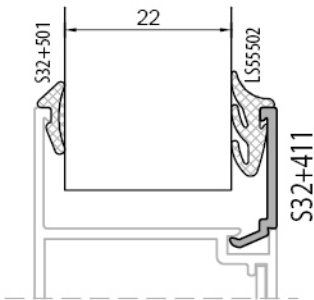
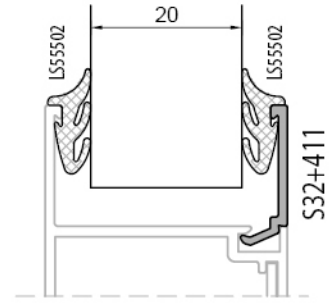
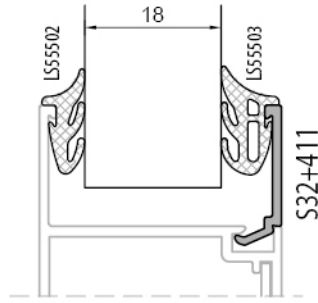
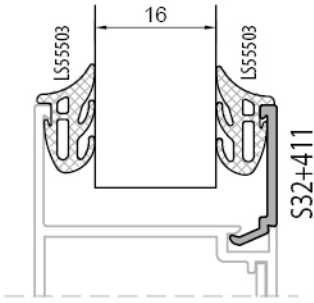
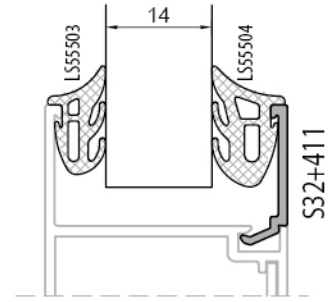
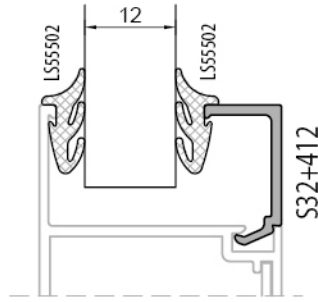
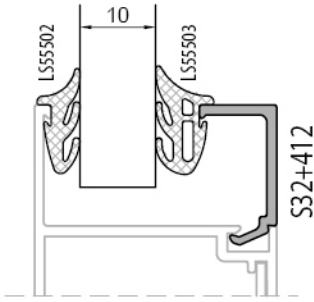
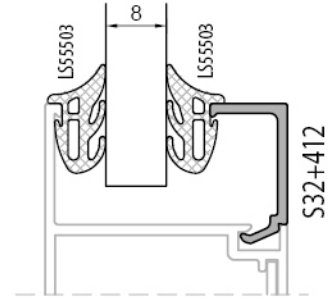
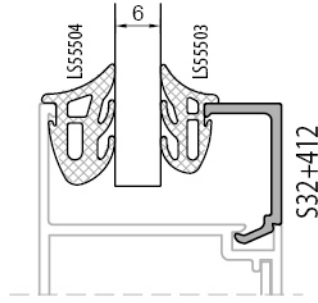
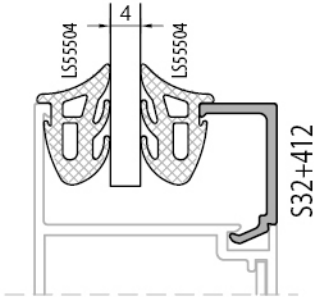

Profil değerleri teoriktir. Ağırlık olarak teslimde yapılan tartım geçerlidir. Profil imalatları TS EN 12020-02 ve TS EN 755-9 toleransı, Moment değerleri EN 14024'e göre hesaplanmıştır.

Profile values are theoretical pre-shipment weight will be valid. The tolerances of Profile manufacturing are calculated according to EN 12020-2 and TS EN 755-9; moment values are calculated according to EN 14024.

S32 KLASİK SÜRME SİSTEM / CLASSICAL SLIDE SYSTEM

ÜRÜN TEKNİK ÖZELLİKLERİ / PRODUCT TECHNICAL FEATURES

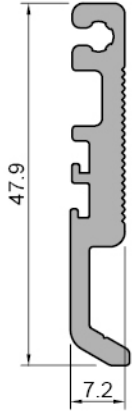

Orta Kayıt Bağlantı
Mullion connection

LS55443

Weight :0,559 kg/m

LS55443-1 10,5 mm

LS55443-2 12,5 mm

LS55443-3 22,5 mm

LS55443-4 42,5 mm

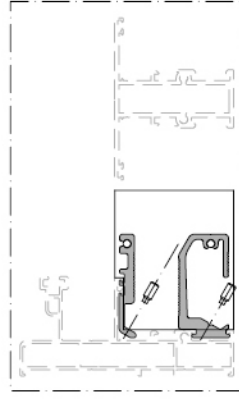

Orta Kayıt Bağlantı
Mullion connection

LS55444

Weight :0,974 kg/m

LS55444-1 10,5 mm

LS55444-2 12,5 mm

LS55444-3 22,5 mm

LS55444-4 42,5 mm

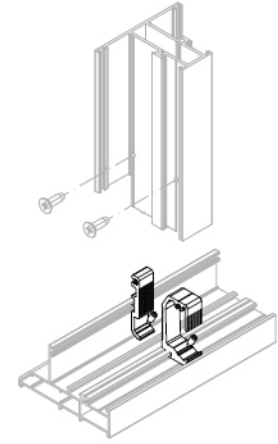
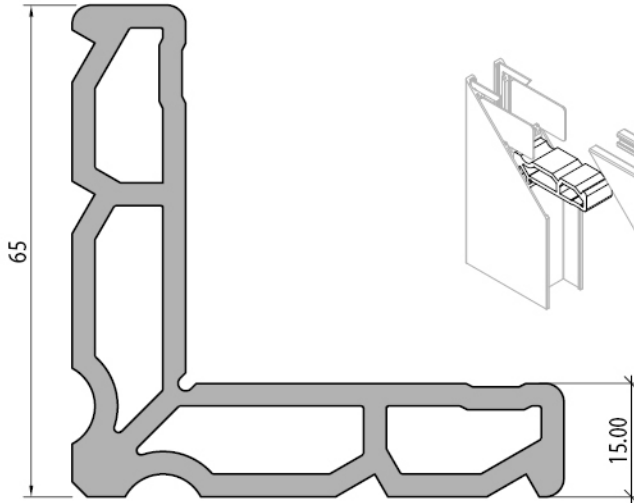
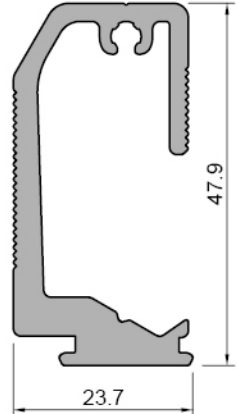

Kasa Köşe Takoz Profili
Frame corner cleat profile

S32405

Weight :2,327 kg/m

S32405-1 22.4mm

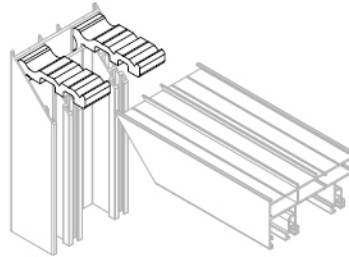
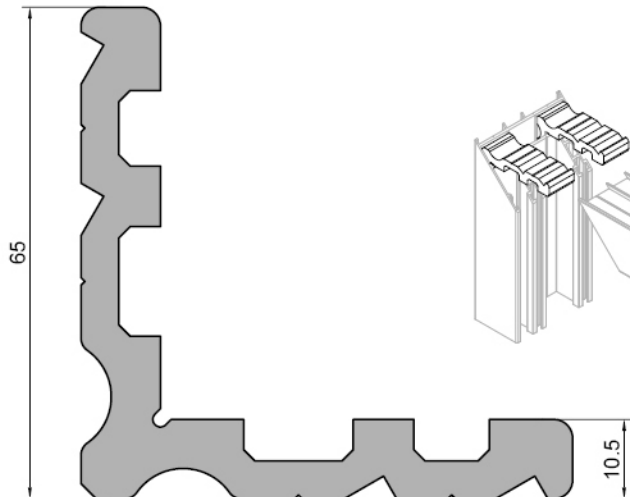









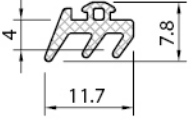

Kasa Köşe Takoz Profili
Frame corner cleat profile

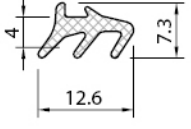
LS55442

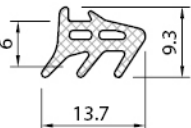
Weight :2,345 kg/m

LS55442-1 24 mm

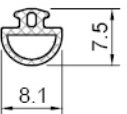
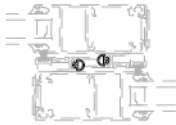
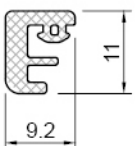
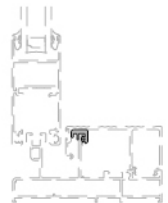
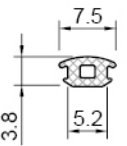
Profil değerleri teoriktir. Ağırılık olarak teslimde yapılan tartım geçerlidir. Profil imatları TS EN 12020-02 ve TS EN 755-9 toleransı, Moment değerleri EN 14024'e göre hesaplanmıştır.
Profile values are theoretical pre-shipment weight will be valid. The tolerances of Profile manufacturing are calculated according to EN 12020-2 and TS EN 755-9; moment values are calculated according to EN 14024.







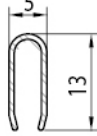
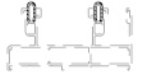

Kod Code	Şekil Drawing	Tanım Description	Teorik Ağırlık Theoretical Weight gr / m	Paket Ağırlığı Package Weight Kg / Package	Paket Metrajı In one Package Metre / Package	Kullanım Yeri Application
LS55501		epdm cam dış fitil glazing gasket outside	55 gr/m	12 kg	220 m	
LS55502		epdm cam iç fitil glazing gasket inside	52 gr/m	12 kg	230 m	
LS55503		epdm cam iç fitil glazing gasket inside	80 gr/m	12 kg	150 m	
LS55504		epdm cam iç fitil glazing gasket inside	92 gr/m	12 kg	130 m	
LS55506		epdm fitil epdm gasket	32 gr/m	12 kg	370 m	
LS55508		epdm fitil epdm gasket	83 gr/m	12 kg	145 m	
LS55510		epdm fitil epdm gasket	27 gr/m	12 kg	440 m	

S32 KLASİK SÜRME SİSTEM / CLASSICAL SLIDE SYSTEM

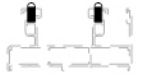
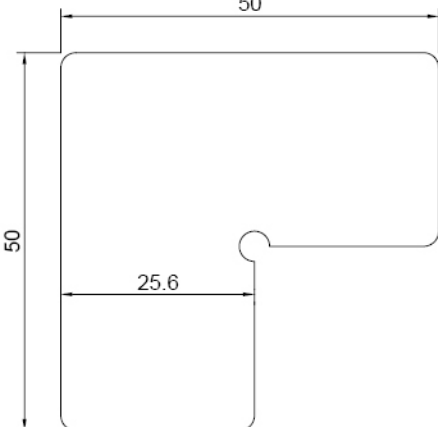
ÜRÜN TEKNİK ÖZELLİKLERİ / PRODUCT TECHNICAL FEATURES

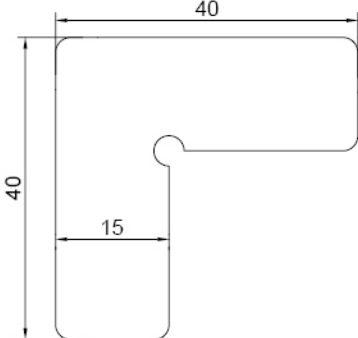

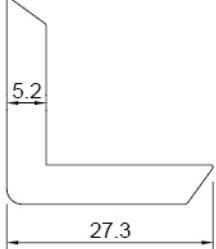





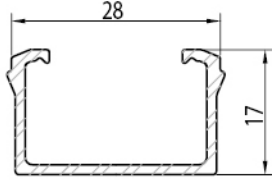

Kod Code	Şekil Drawing	Tanım Description	Teorik Ağırlık Theoretical Weight gr / m	Paket Ağırlığı Package Weight Kg / Package	Paket Metrajı In one Package Metre / Package	Kullanım Yeri Application
S32+501		epdm fitil epdm gasket	22 gr/m	12 kg	545 m	
S32501		epdm fitil epdm gasket	11 gr/m	10 kg	93 m	
W55.511		epdm fitil epdm gasket	18 gr/m	10 kg	555 m	
LS55520		perdeli fırça fitil rabbet brush gasket	-	-	450 m/pk	
LS55521		perdeli fırça fitil rabbet brush gasket	-	-	250 m/pk	
LS55615		kasa köşe bağlantı sash corner assamble			150 m/pk	

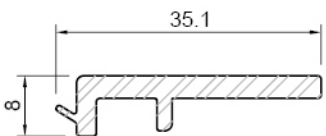
Profil değerleri teoriktir. Ağırlık olarak teslimde yapılan tartım geçerlidir. Profil imalatları TS EN 12020-02 ve TS EN 755-9 toleransı, Moment değerleri EN 14024'e göre hesaplanmıştır.
Profile values are theoretical pre-shipment weight will be valid. The tolerances of Profile manufacturing are calculated according to EN 12020-2 and TS EN 755-9; moment values are calculated according to EN 14024.

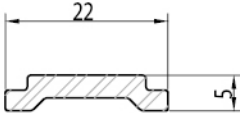
Kod Code	Şekil Drawing	Tanım Description	Paket Metraji In one Package Metre / Package	Kullanım Yeri Application
LS55616		paslanmaz çelik ray profili stainless steel rail profile	6,5 m 10 pcs/pk	
LS55620		alüminyum ray profili aluminium rail profile	6,0 m 1 kg	
S32601		köşe onbaşı corner cleat for sash	200 pcs/pk	
LS55618		köşe onbaşı corner cleat for sash	200 pcs/pk	
S32+602		köşe onbaşı corner cleat for sash	200 pcs/pk	

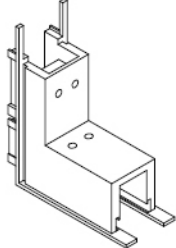
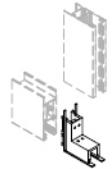
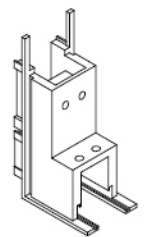
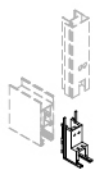
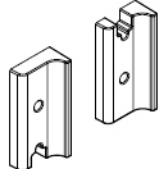
S32 KLASİK SÜRME SİSTEM / CLASSICAL SLIDE SYSTEM

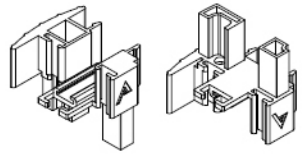
ÜRÜN TEKNİK ÖZELLİKLERİ / PRODUCT TECHNICAL FEATURES





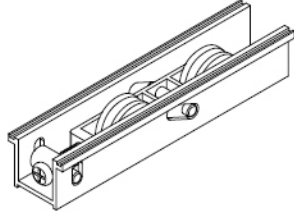
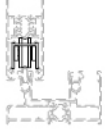
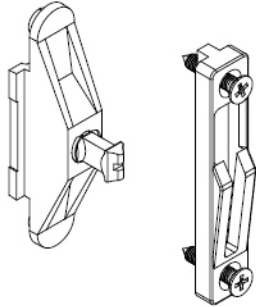
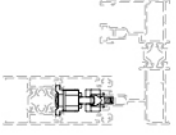
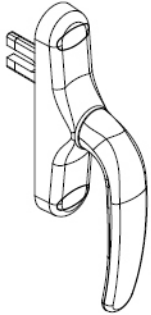
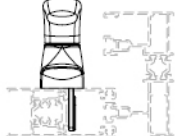
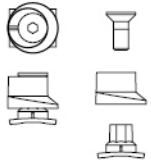
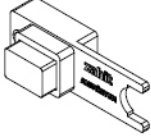

Kod Code	Şekil Drawing	Tanım Description	Paket Metrajı In one Package Metre / Package	Kullanım Yeri Application
S32+612		pvc cam fitil adaptörü gasket glazing pvc adapter	3,0 m 20 pcs/pk	
LS55603		pvc cam destek takoz pvc glazing support cleat	3,0 m 20 pcs/pk	
S32+613		pvc tij profili pvc stick profile	3,0 m 20 pcs/pk	
S32+620		pvc kanat köşe birleşim pvc sash corner join	24 pcs/pk	
S32+621		pvc kanat köşe birleşim pvc sash corner join	24 pcs/pk	
S32+624		kenet kapak clamp cover	100 pcs/pk	
S32+625		çift kanat birleşim adaptörü double sash connecting adapter	24 pcs/pk	

Profil değerleri teoriktir. Ağırlık olarak teslimde yapılan tartım geçerlidir. Profil imalatları TS EN 12020-02 ve TS EN 755-9 toleransı, Moment değerleri EN 14024'e göre hesaplanmıştır.
Profile values are theoretical pre-shipment weight will be valid. The tolerances of Profile manufacturing are calculated according to EN 12020-2 and TS EN 755-9; moment values are calculated according to EN 14024.

Kod Code	Şekil Drawing	Tanım Description	Paket Metrajı In one Package Metre / Package	Kullanım Yeri Application
S32+701		klasik sürme rulman classical sliding roller	50 pcs/pk	
S32+702		kilitleme takımı (çok noktadan) multipoint locking set	50 pcs/pk	
S32+703		kilitleme kolu multipoint locking handle	25 pcs/pk	
S32+704		pim locking pawl	100 pcs/pk	
S32+705		çarpma takozu damper plugs	100 pcs/pk	

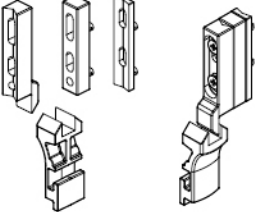
S32 KLASİK SÜRME SİSTEMİ / CLASSICAL SLIDE SYSTEM

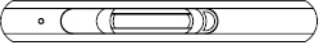
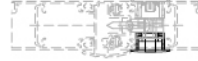
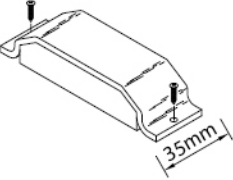
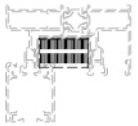
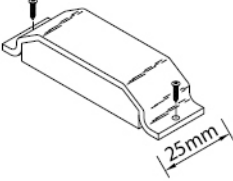
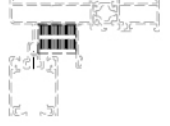
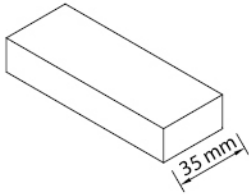
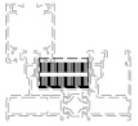
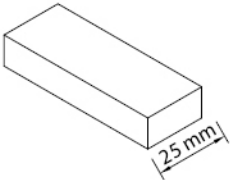
ÜRÜN TEKNİK ÖZELLİKLERİ / PRODUCT TECHNICAL FEATURES

Kod Code	Şekil Drawing	Tanım Description	Paket Metrajı In one Package Metre / Package	Kullanım Yeri Application
S32+706		havuz kol recessed handle	20 pcs/pk	
S32+707		kilitleme takımı locking set	25 pcs/pk	
S32+708		çekme kol pull handle	25 pcs/pk	
S32+801		kanal üst izolasyon channel upper insulation	100 pcs/pk	
S32+802		kanal üst izolasyon channel upper insulation	100 pcs/pk	
S32+803		kanal alt izolasyon channel bottom insulation	100 pcs/pk	
LS55804		kanal alt izolasyon channel bottom insulation	100 pcs/pk	

Profil değerleri teoriktir. Ağırlık olarak teslimde yapılan tartım geçerlidir. Profil imalatları TS EN 12020-02 ve TS EN 755-9 toleransı, Moment değerleri EN 14024'e göre hesaplanmıştır.
Profile values are theoretical pre-shipment weight will be valid. The tolerances of Profile manufacturing are calculated according to EN 12020-2 and TS EN 755-9; moment values are calculated according to EN 14024.

1 - RAY-SABİT PROFİL SİSTEMİ

1 - RAIL-FIXED PROFILE SYSTEM

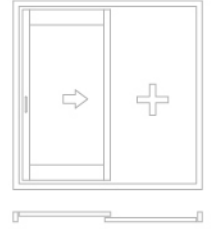
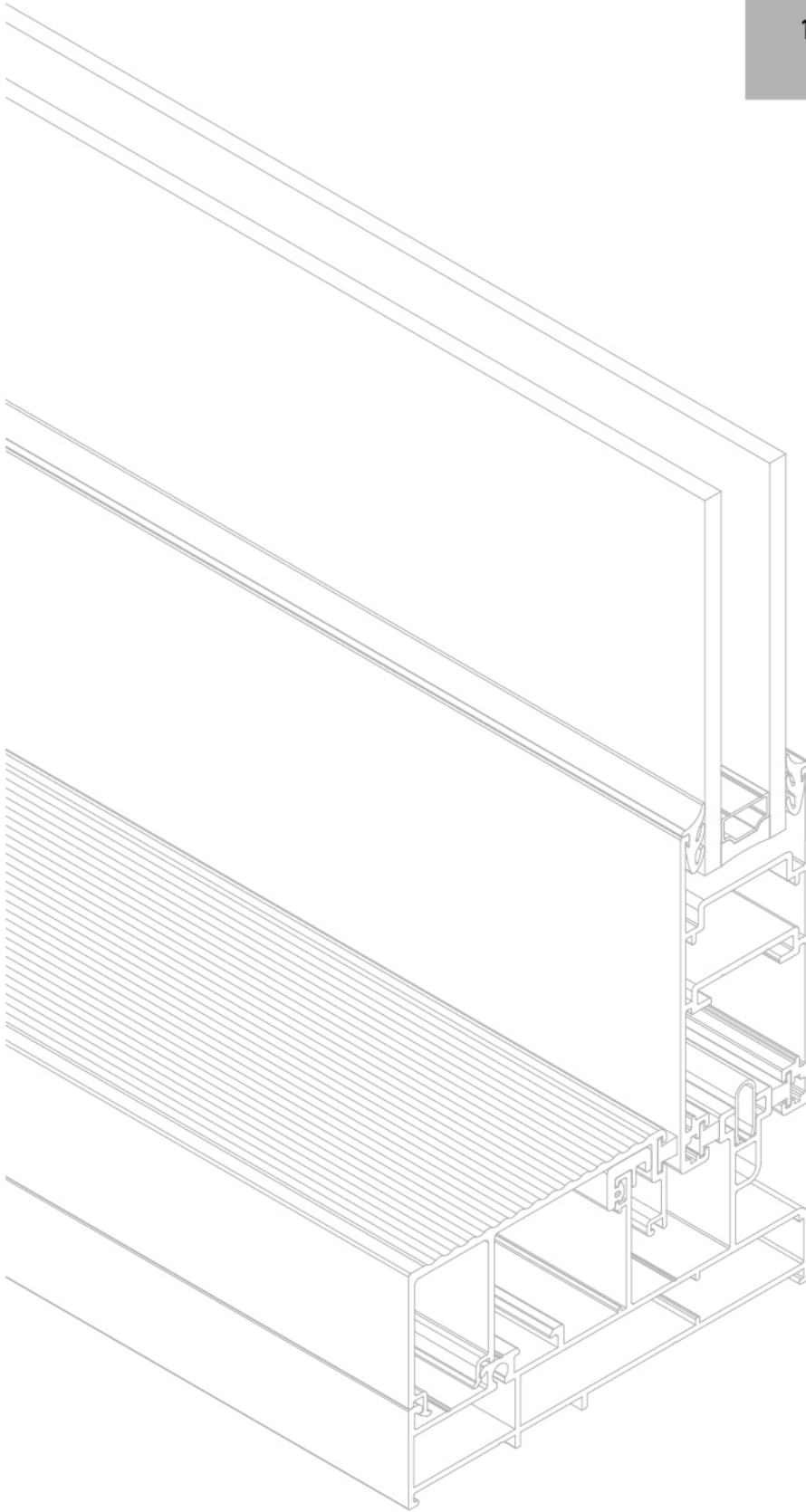

S32 KLASİK SÜRME SİSTEM / CLASSICAL SLIDE SYSTEM

SİSTEM DETAYLARI / SYSTEM DETAILS

klasik sürme açılım sistemi detayı
classical sliding opening system detail

1 - ray 1 - rail

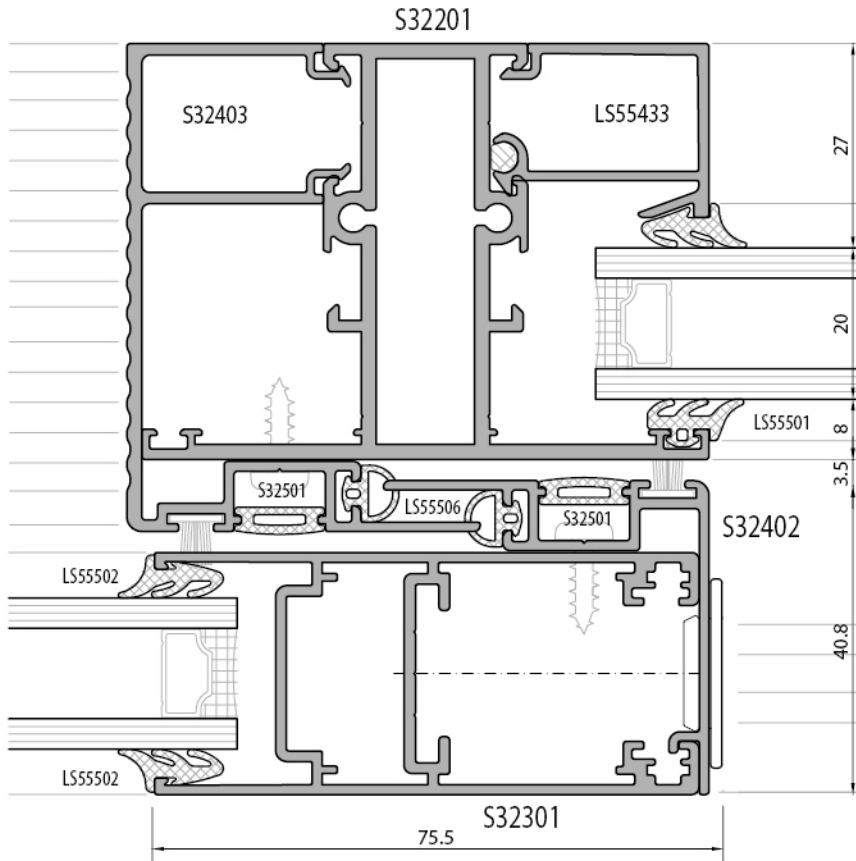
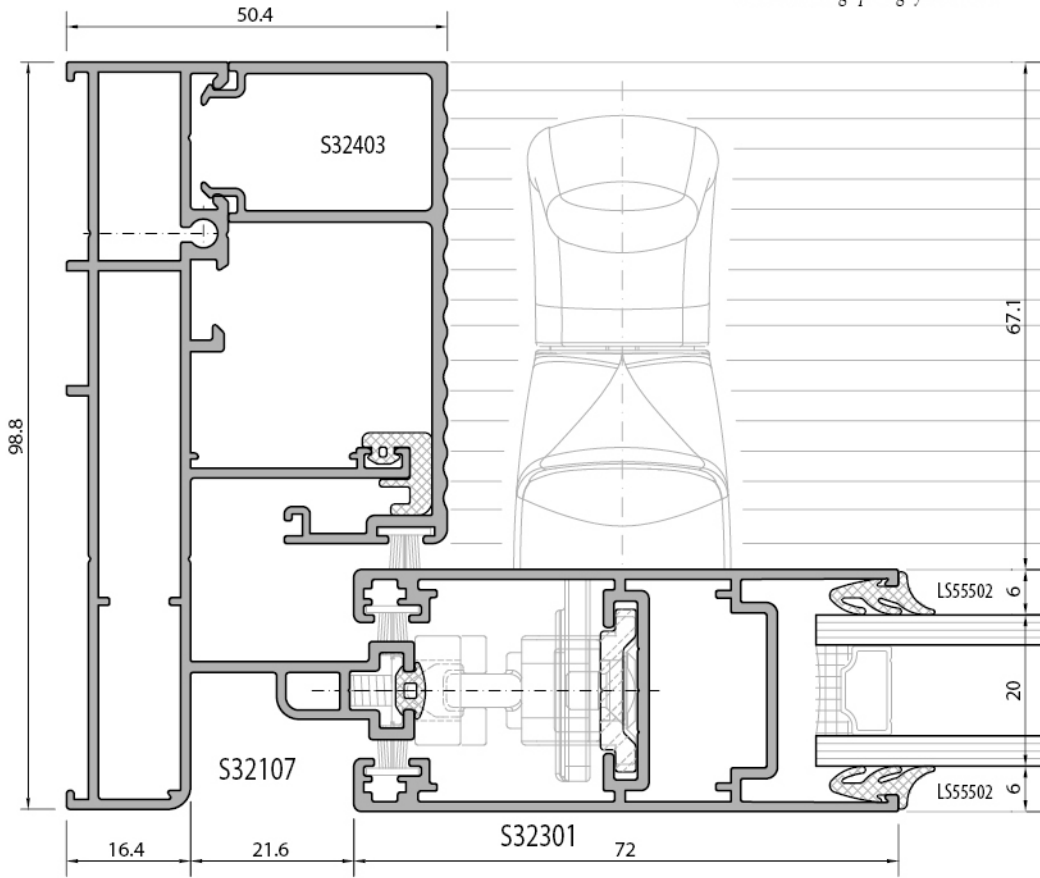
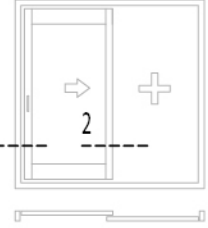

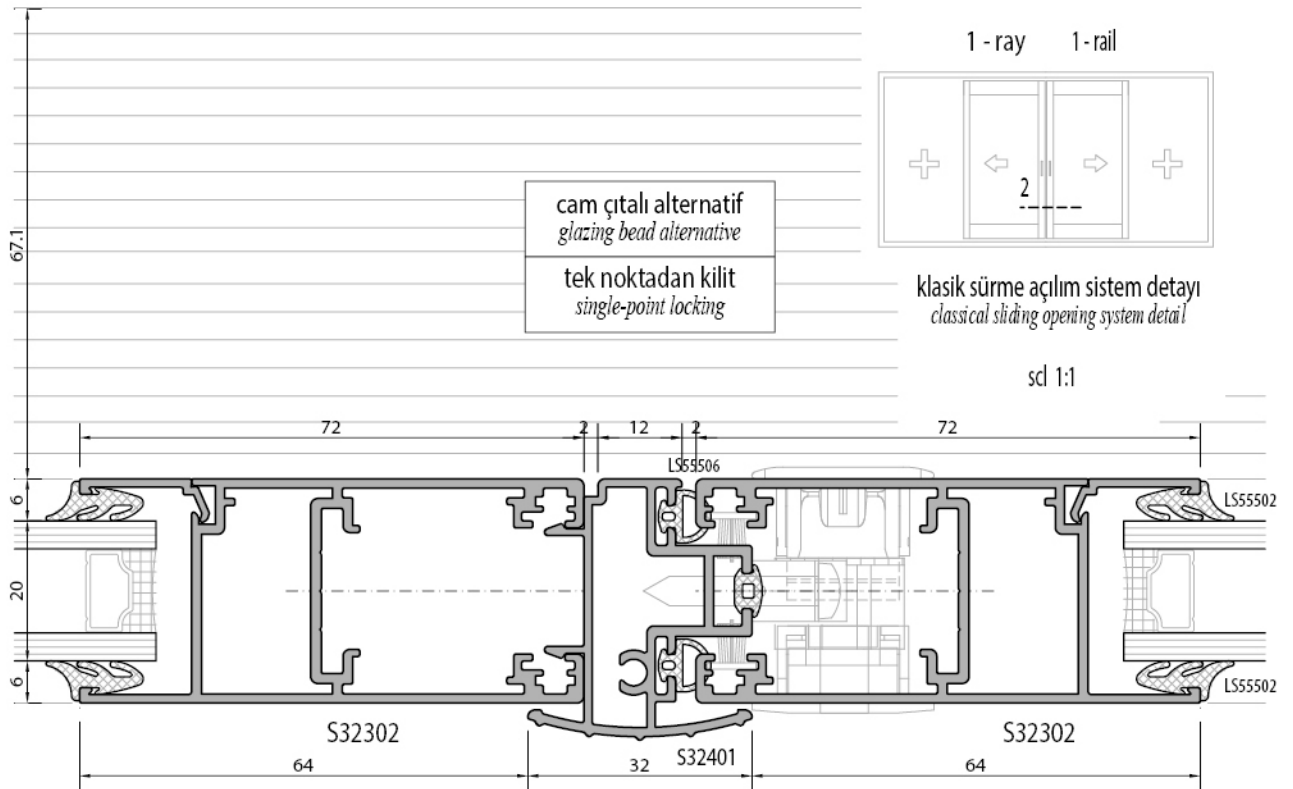
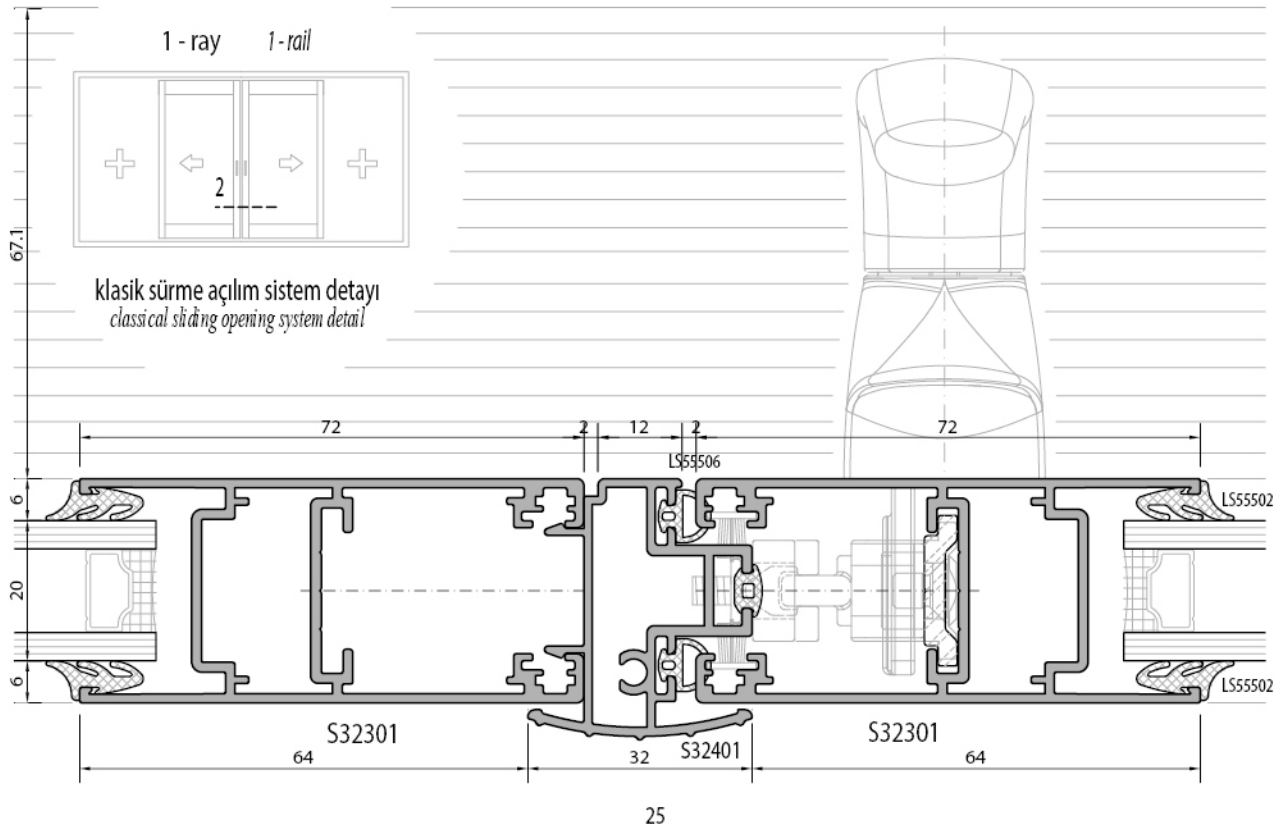

S32 KLASİK SÜRME SİSTEM / CLASSICAL SLIDE SYSTEM
SİSTEM DETAYLARI / SYSTEM DETAILS

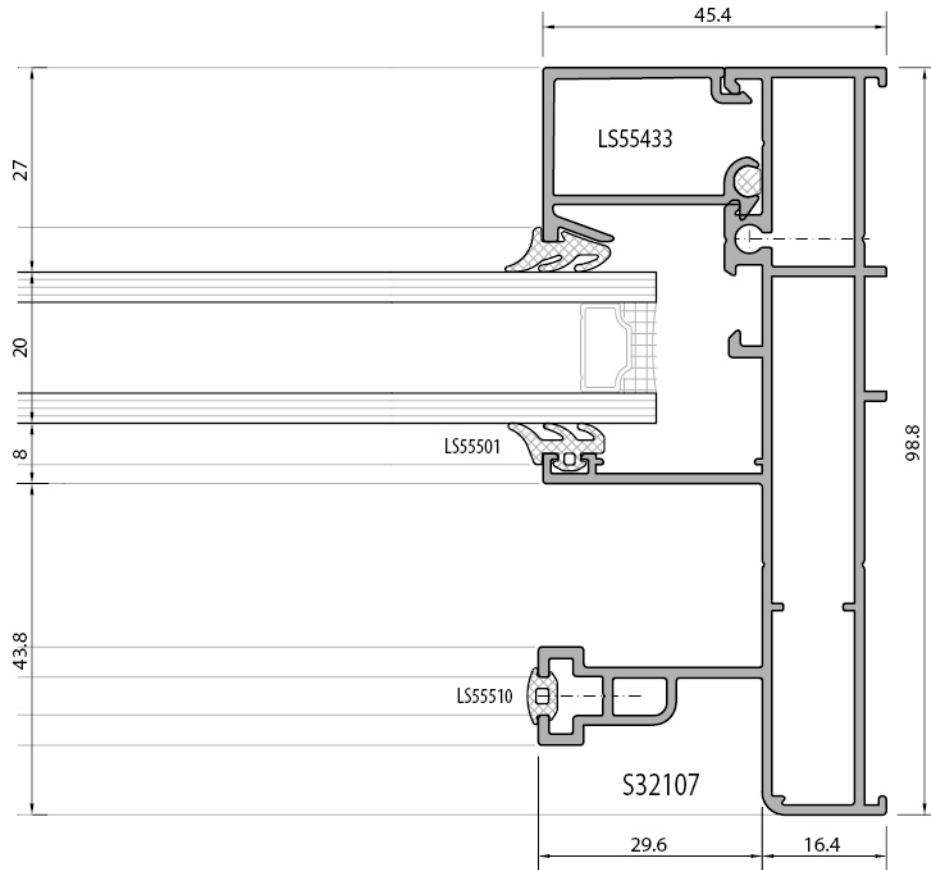
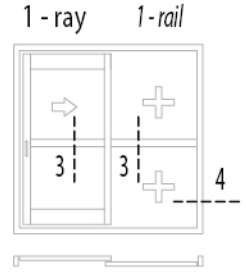
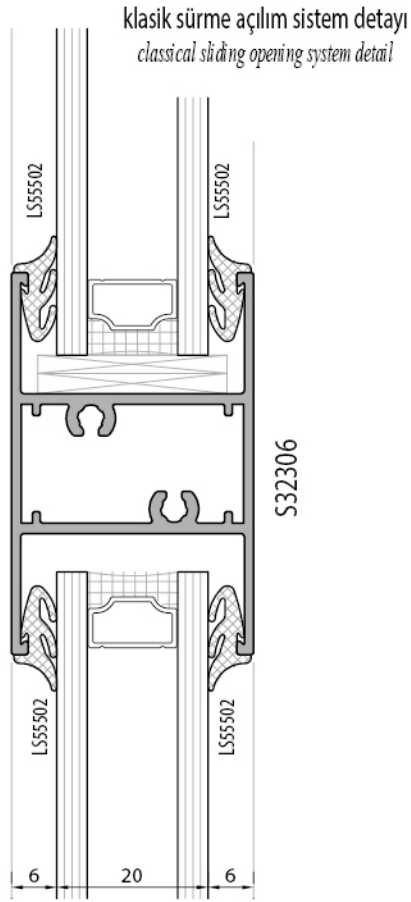
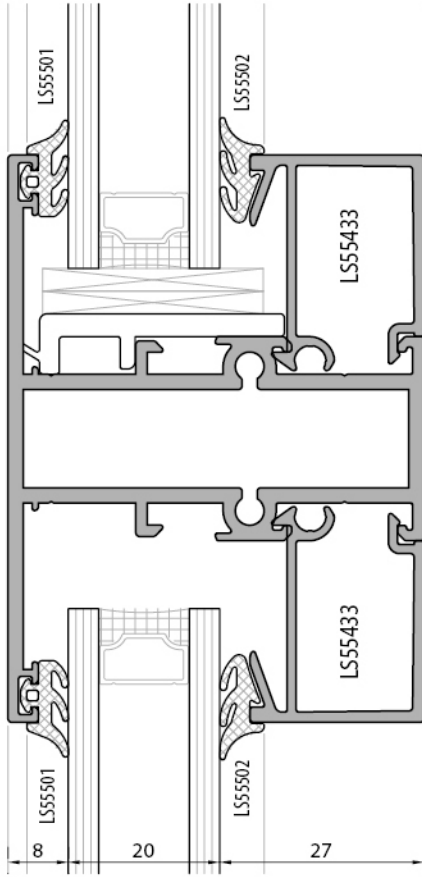

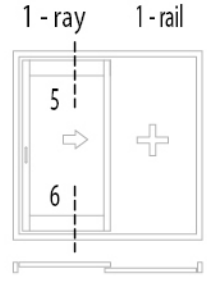
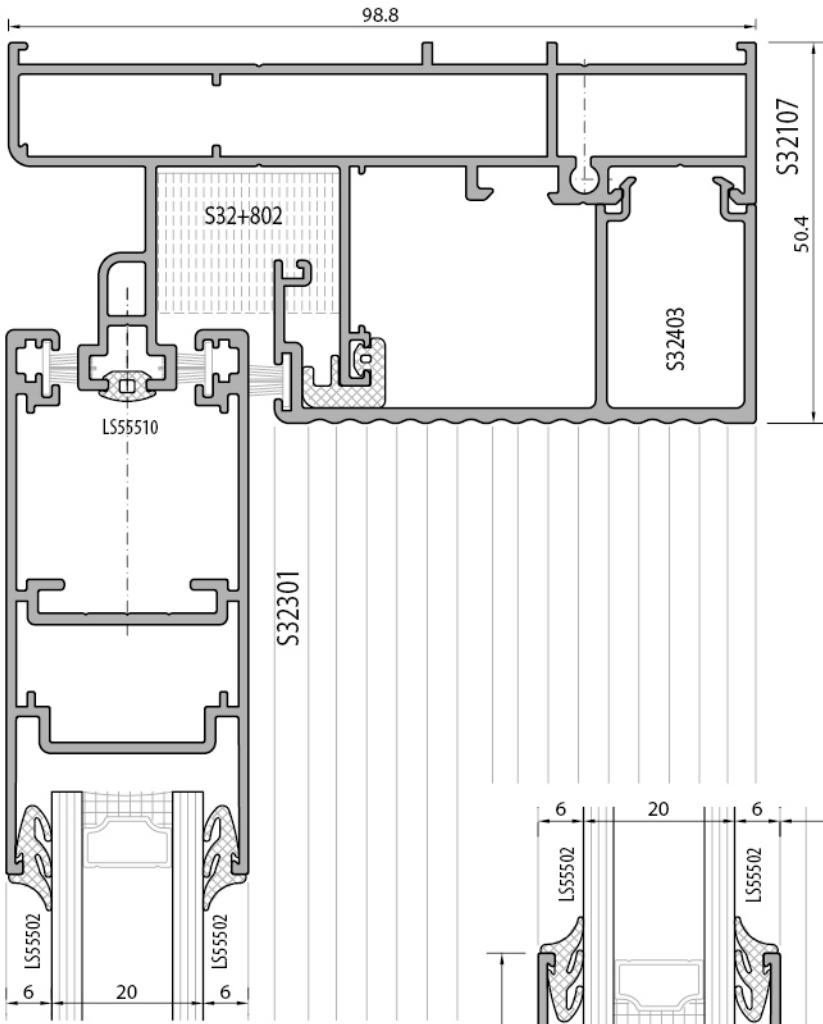

klasik sürme açılım sistem detayı
classical sliding opening system detail

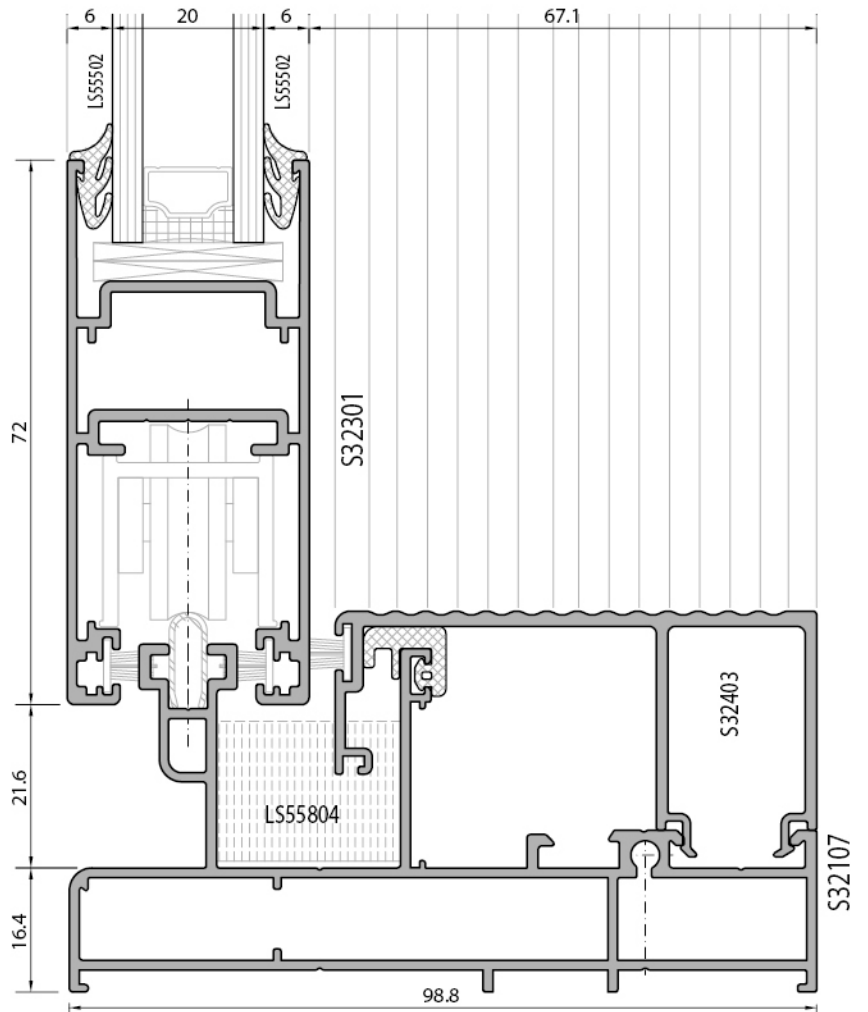

S32 KLASİK SÜRME SİSTEM / CLASSICAL SLIDE SYSTEM
SİSTEM DETAYLARI / SYSTEM DETAILS

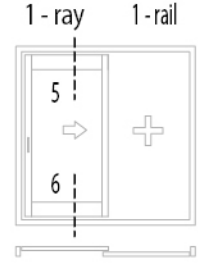
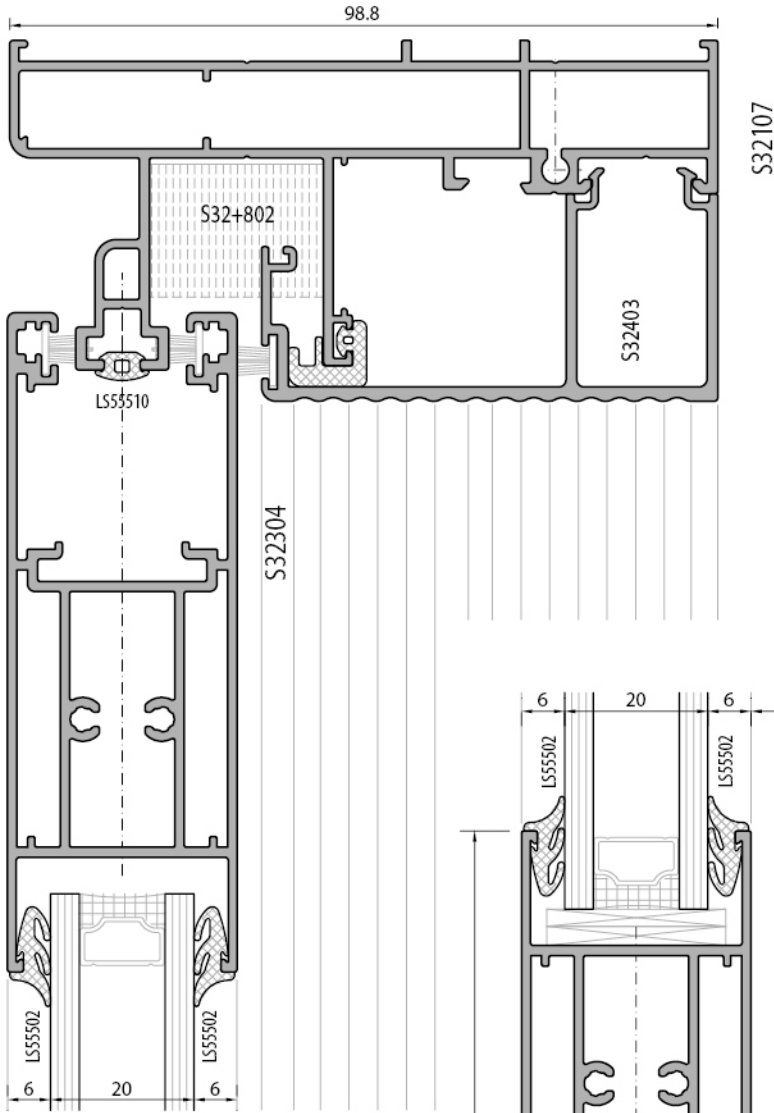

klasik sürme açılım sistem detayı
classical sliding opening system detail

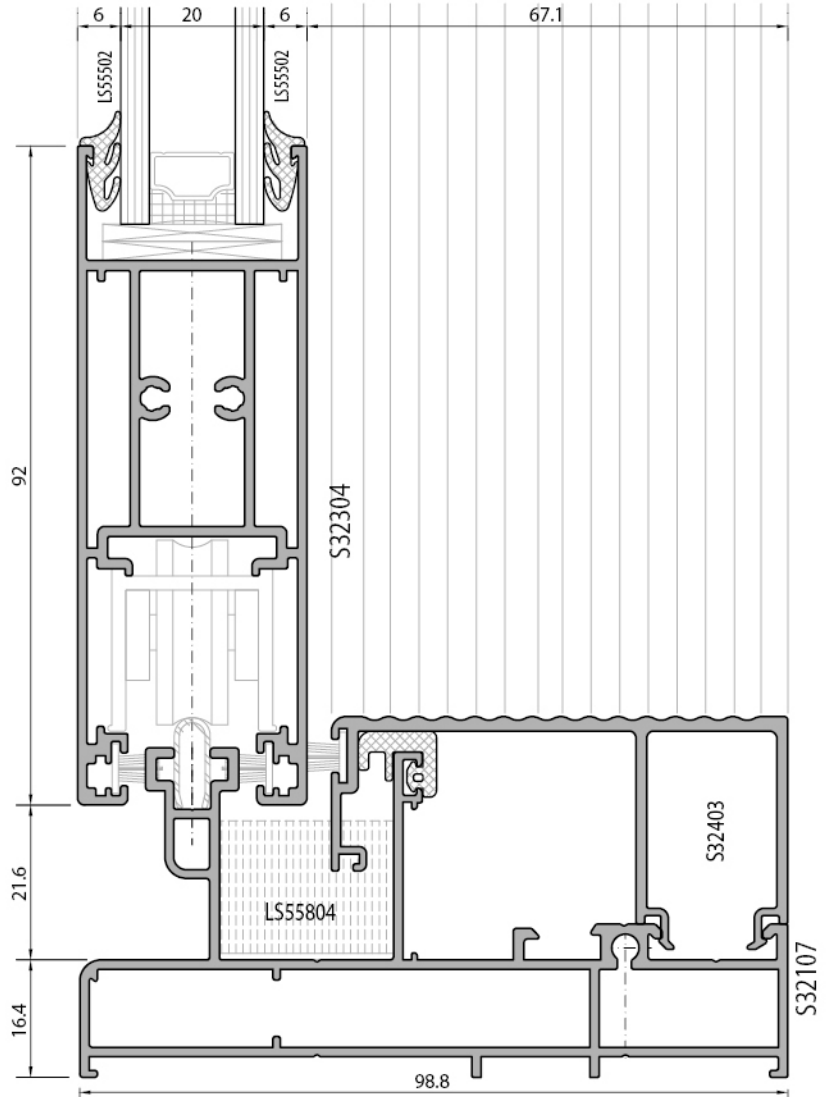
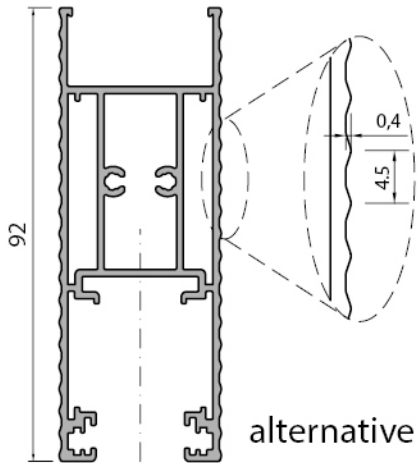

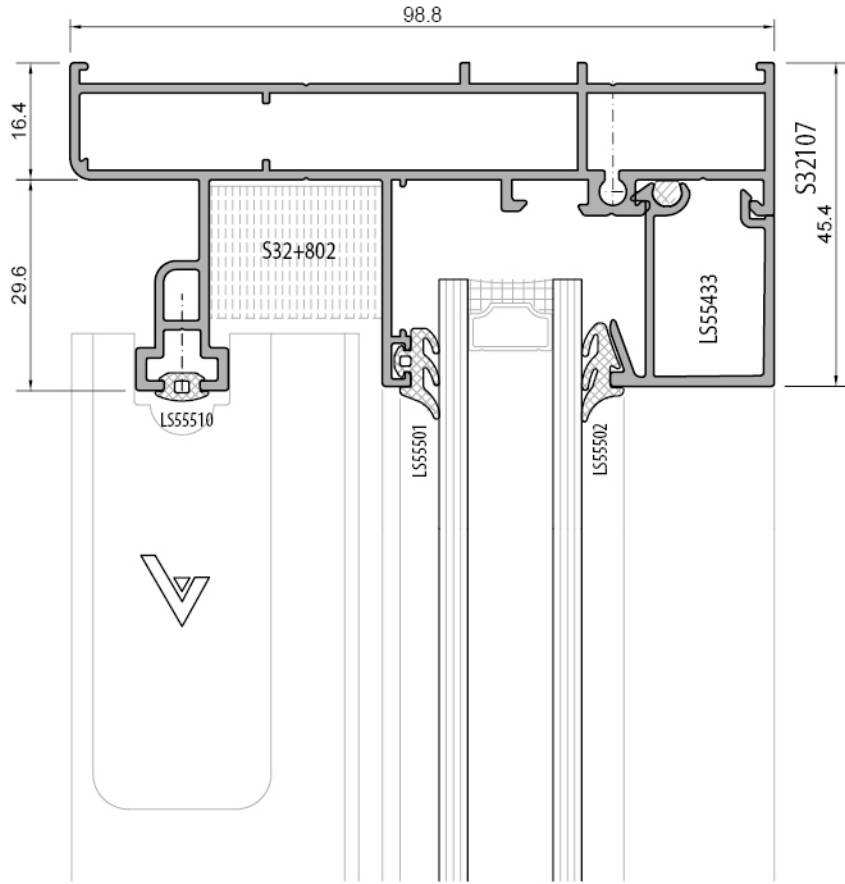

klasik sürme açılım sistem detayı
classical sliding opening system detail

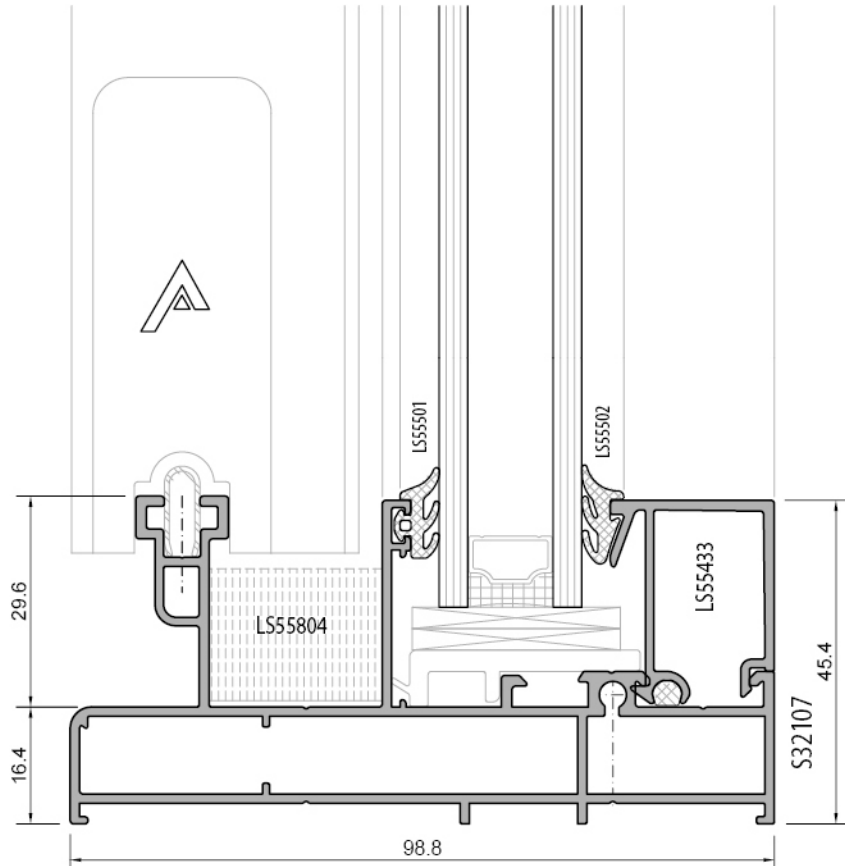

KLASİK SÜRME AÇILIM
CLASSICAL SLIDING OPENING

İmalat ve Kesim Planı
Cutting Dimensions

Sürme Eni	: L
sürme Yüksekliği	: H
Kanat Eni	: KL
Baza Kanat Eni	: BKL
Kanat Yüksekliği	: KH
Kanat Cam Eni	: KCL
Kanat Cam Yük	: KCH
Sabit Cam Eni	: SCL
Sabit Cam Yüksekliği	: SCH
Baza Kanat Cam Yük.	: BCH
Kanat Çita Eni	: K.Cita L
Kanat Çita Yük.	: K.Cita H
Sabit Çita Eni	: S.Cita L
Sabit Çita Yüksekliği	: S.Cita H
Adaptör Çita Eni	: L/2-1
Adaptör Çita H	: H-101
Kenet Profili H	: H-76
Orta Kayıt Profili H	: H-43

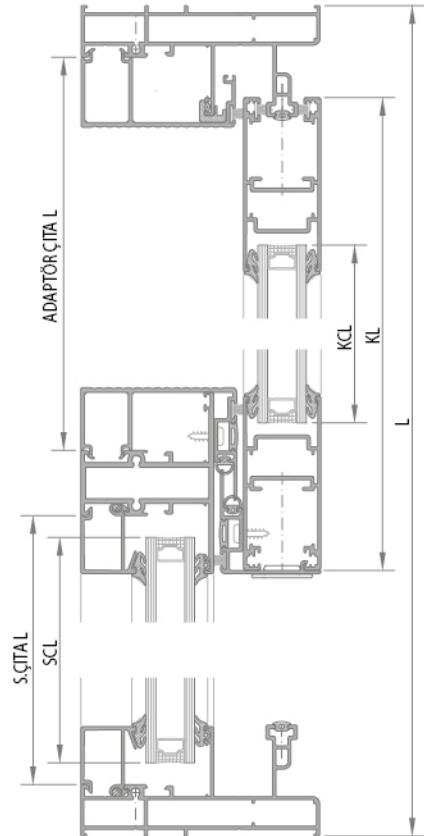
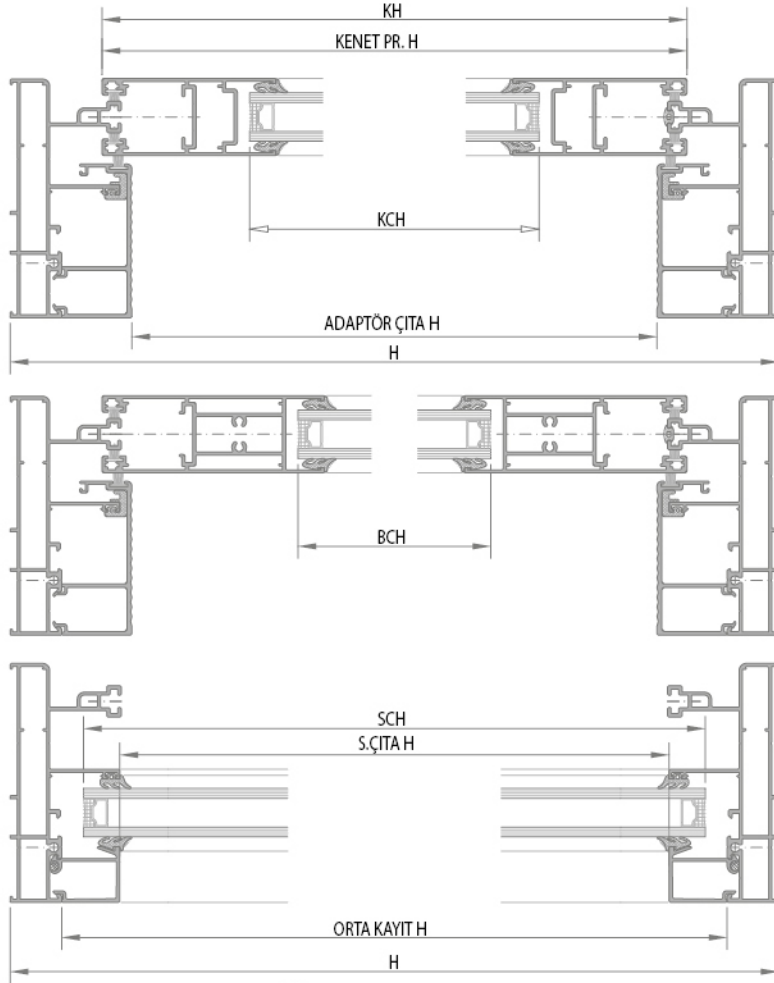

* Hesap yöntemi camların eşit olma esasına göre yapılmıştır.
The calculation method was made on the basis of the equality of the glasses.

* Hesaplama orta kayıt profili S32201'e göre yapılmıştır.
The calculation was made on the mullion profile S32201.

KLASİK SÜRME AÇILIM
CLASSICAL SLIDING OPENING

1 - ray
1 - rail

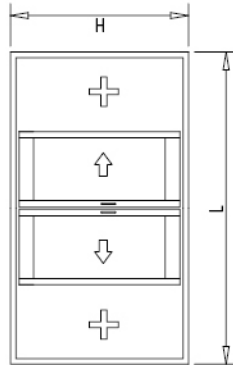
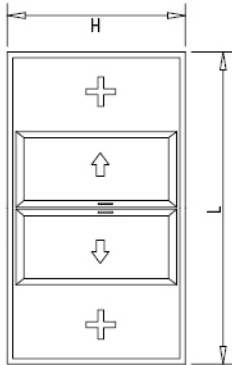

İmalat ve Kesim Planı

Cutting Dimensions

Sürme Eni	: L
Sürme Yüksekliği	: H
Kanat Eni	: KL
Baza Kanat Eni	: BKL
Kanat Yüksekliği	: KH
Kanat Cam Eni	: KCL
Kanat Cam Yüksekliği	: KCH
Sabit Cam Eni	: SCL
Sabit Cam Yüksekliği	: SCH
Baza Kanat Cam Yüksekliği	: BCH
Kanat Çıta Eni	: K Çita L
Kanat Çıta Yüksekliği	: K Çita H
Sabit Çıta Eni	: S Çita L
Sabit Çıta Yüksekliği	: S Çita H
Adaptör Çıta Eni	: (2KL+16)-100
Adaptör Çıta Yüksekliği	: H-101
Kenet Profili H	: KL-29
Orta Kayıt Profili H	: H-43

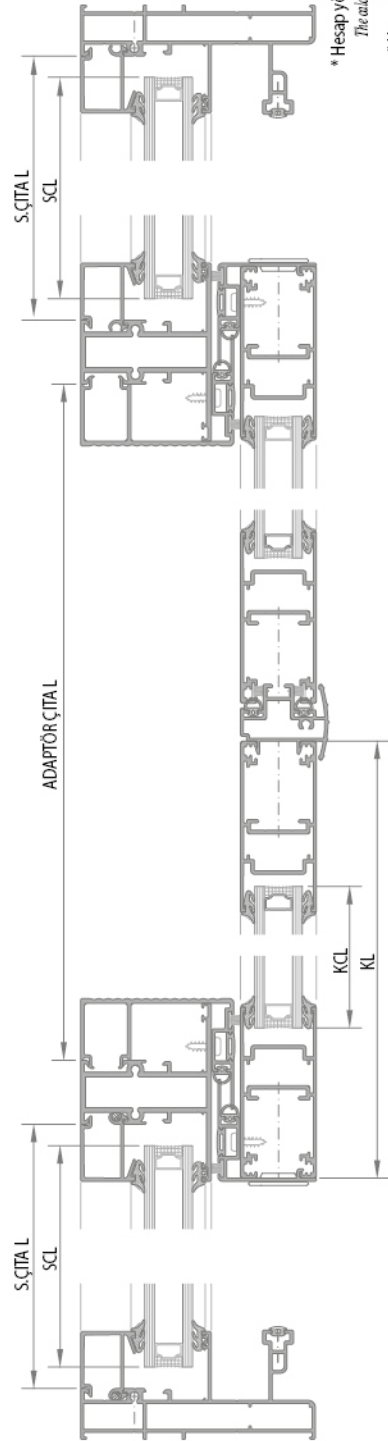
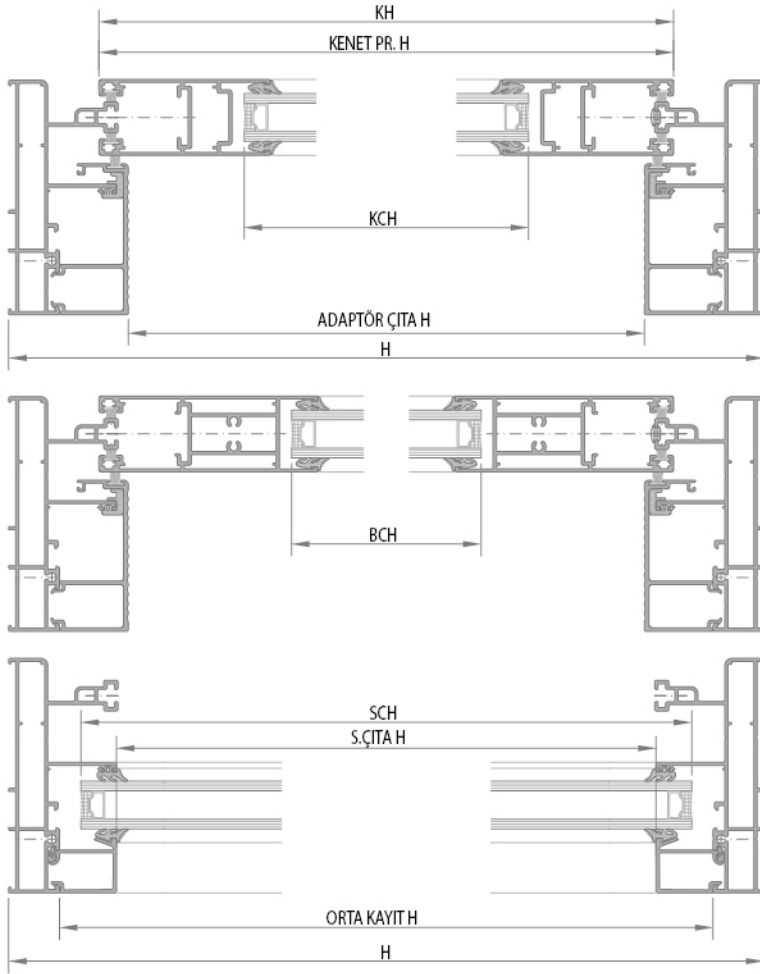

* Hesap yöntemi camların eşit olma esasına göre yapılmıştır.
The calculation method was made on the basis of the equality of the glasses.

* Hesaplama orta kayıt profili S32.20'ye göre yapılmıştır.
The calculation was made on the multi-line profile S32.20.

2 - RAY PROFİL SİSTEMİ
2 - RAIL PROFILE SYSTEM

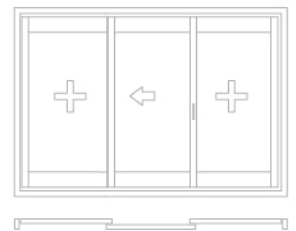
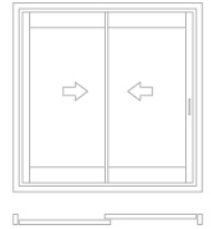
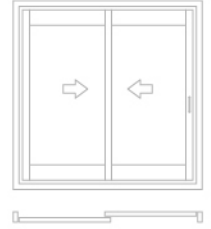
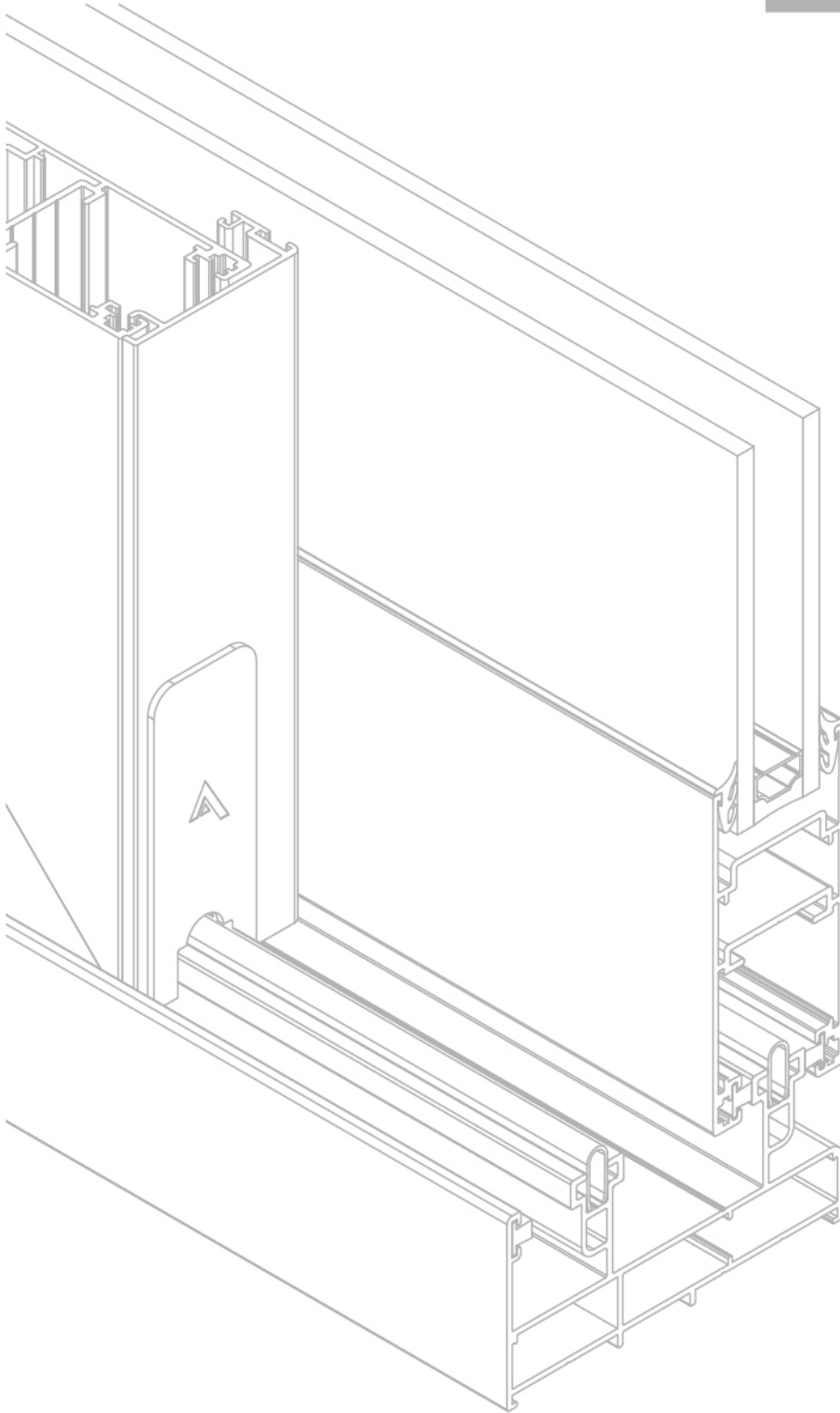

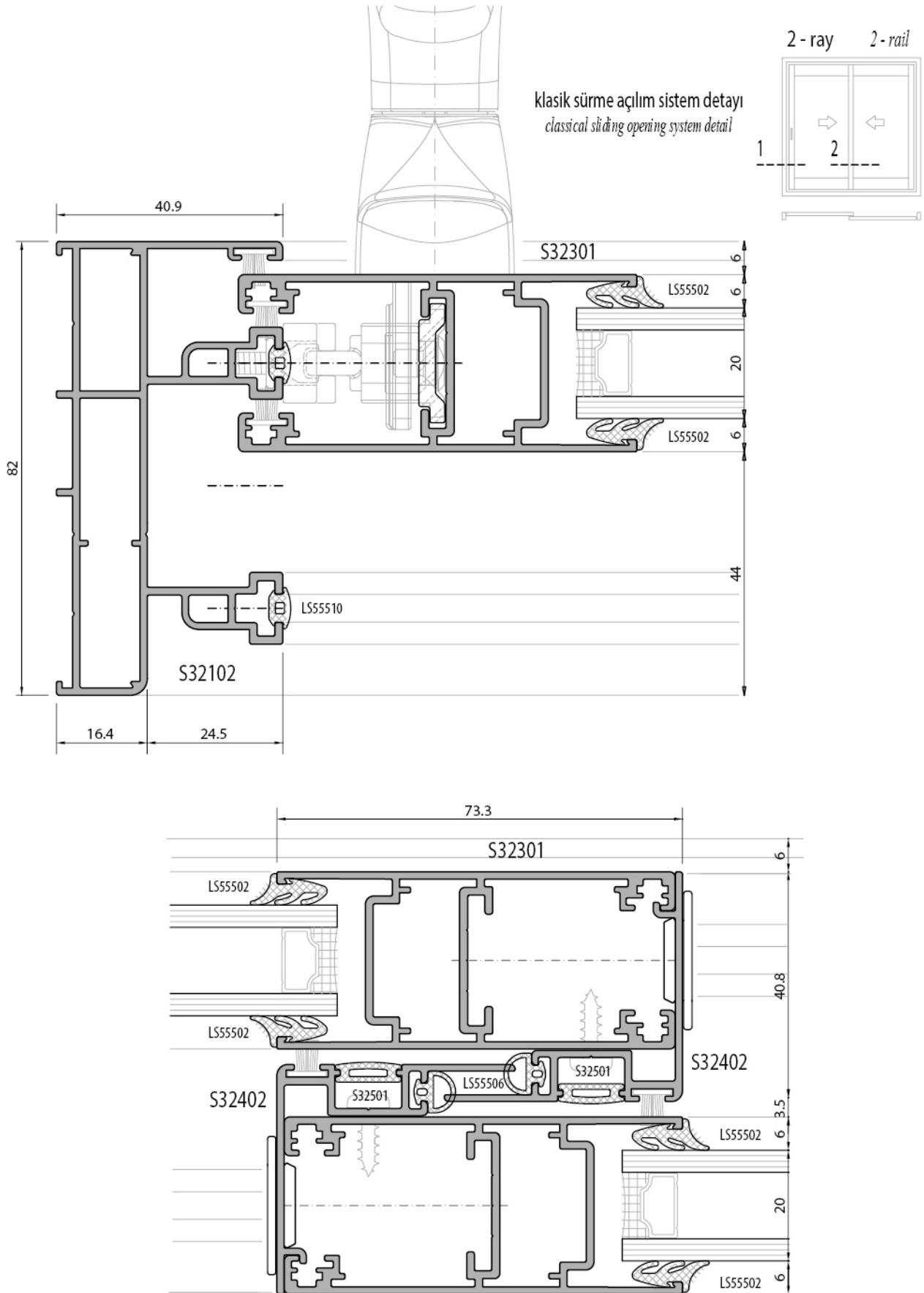

S32 KLASİK SÜRME SİSTEM / CLASSICAL SLIDE SYSTEM

SİSTEM DETAYLARI / SYSTEM DETAILS

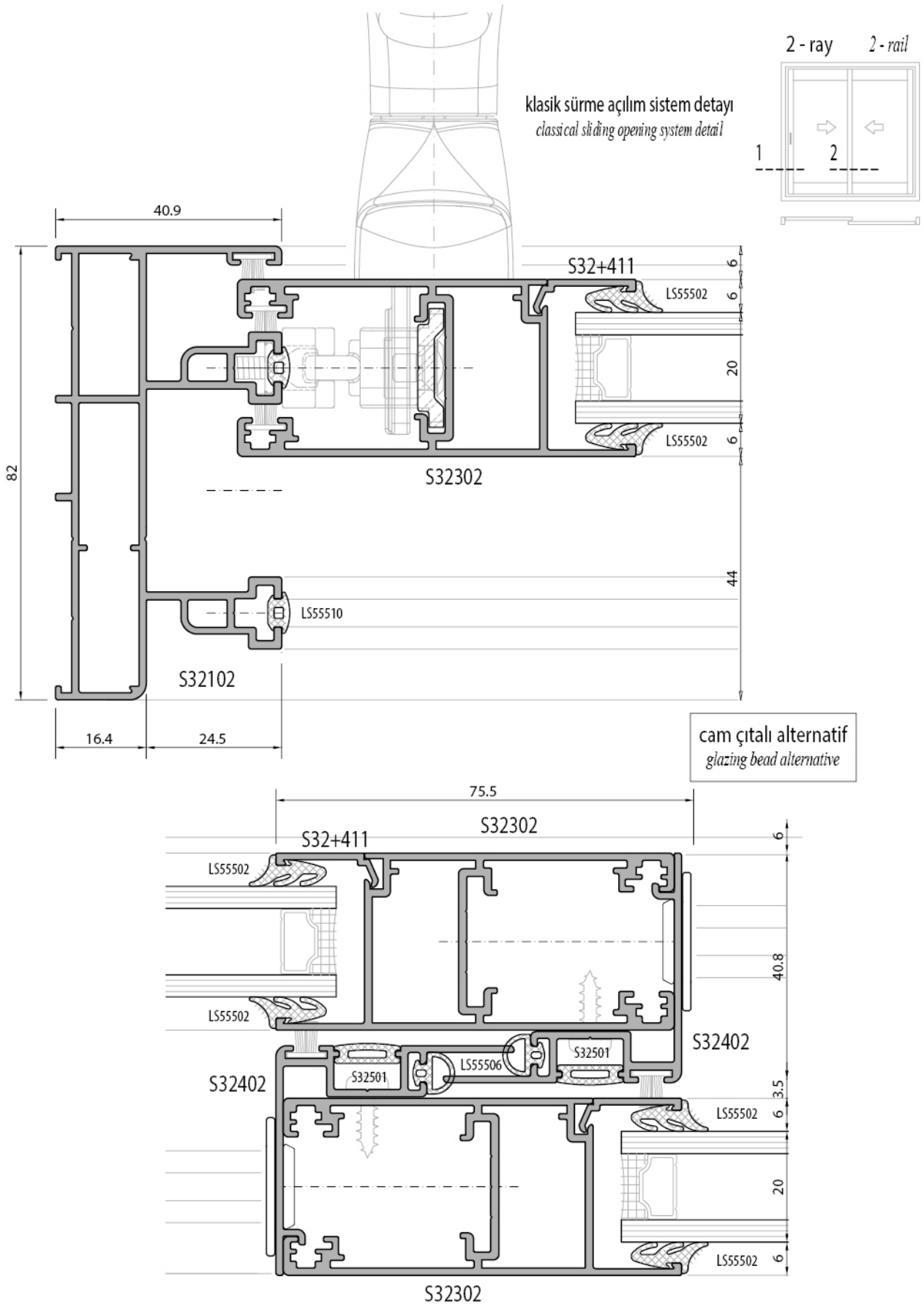

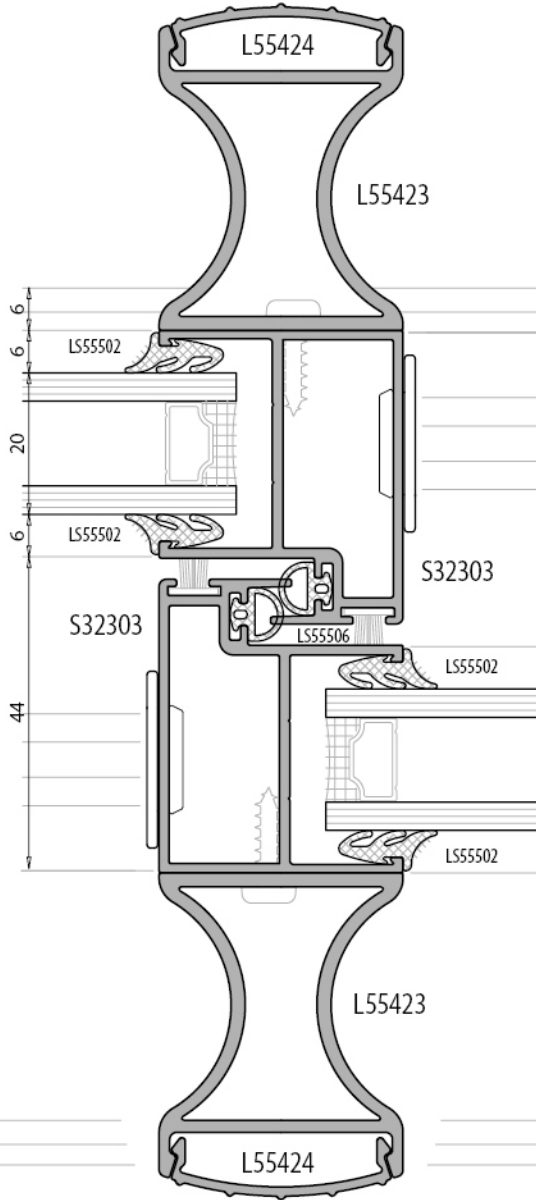

2 - ray 2 - rail



klasik sürme açılım sistem detayı
classical sliding opening system detail

2 - ray 2 - rail

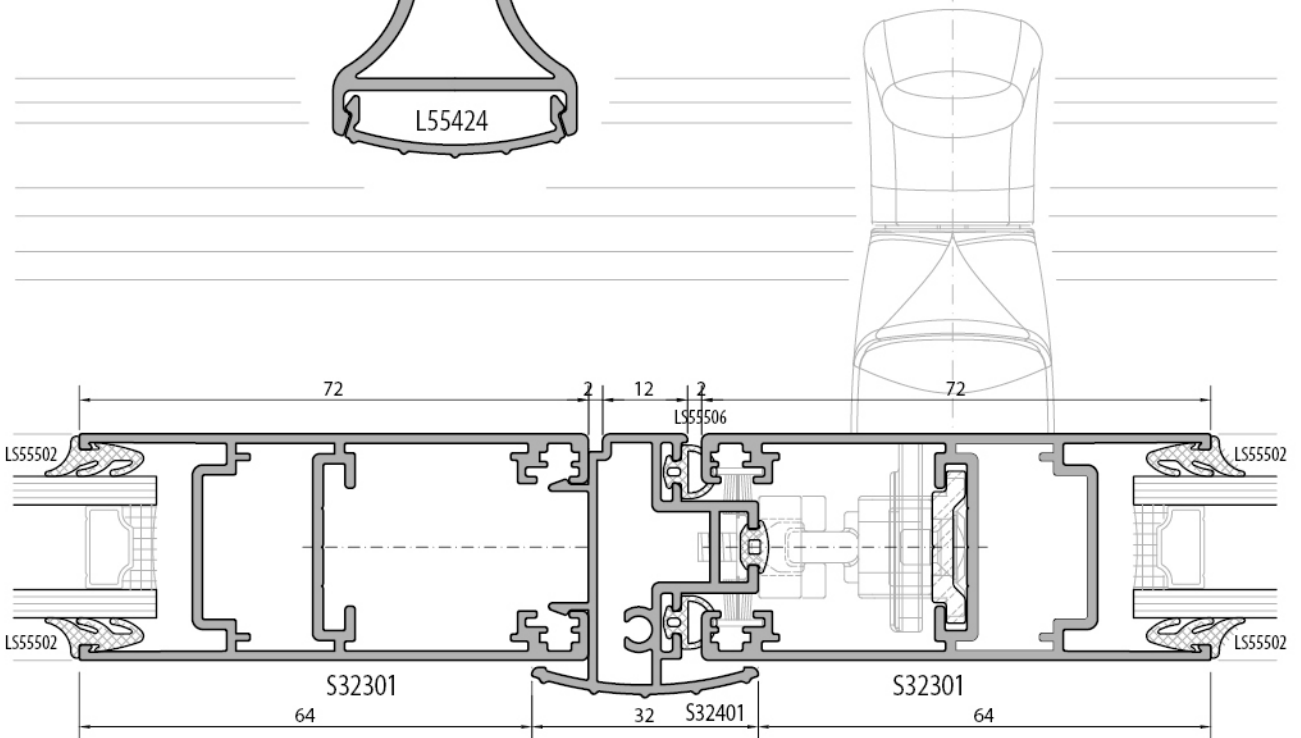
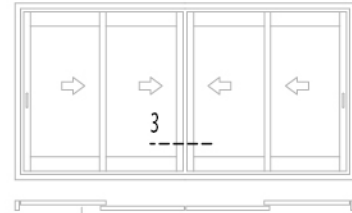

S32 KLASİK SÜRME SİSTEM / CLASSICAL SLIDE SYSTEM

SİSTEM DETAYLARI / SYSTEM DETAILS

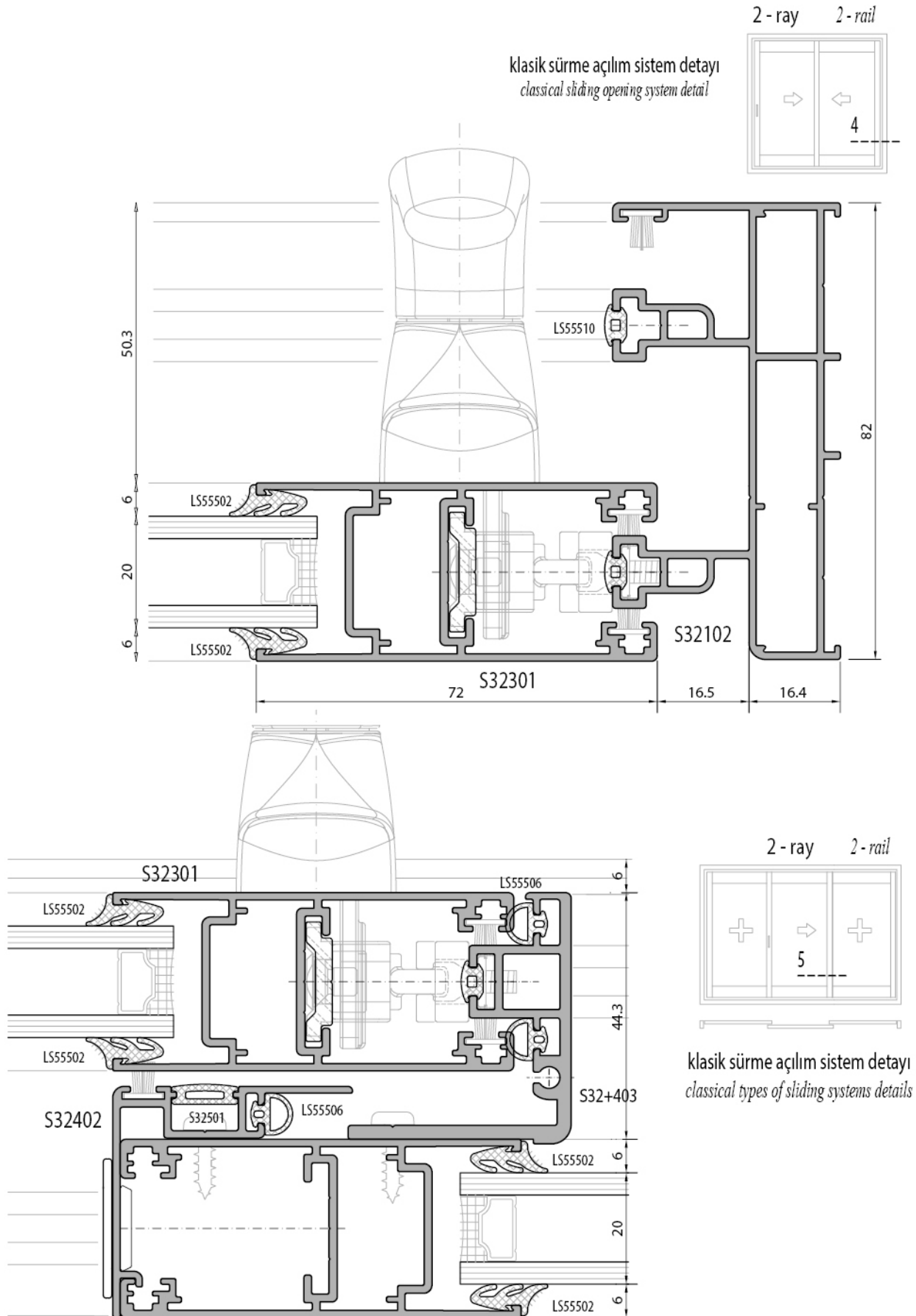

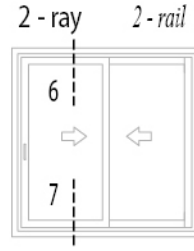
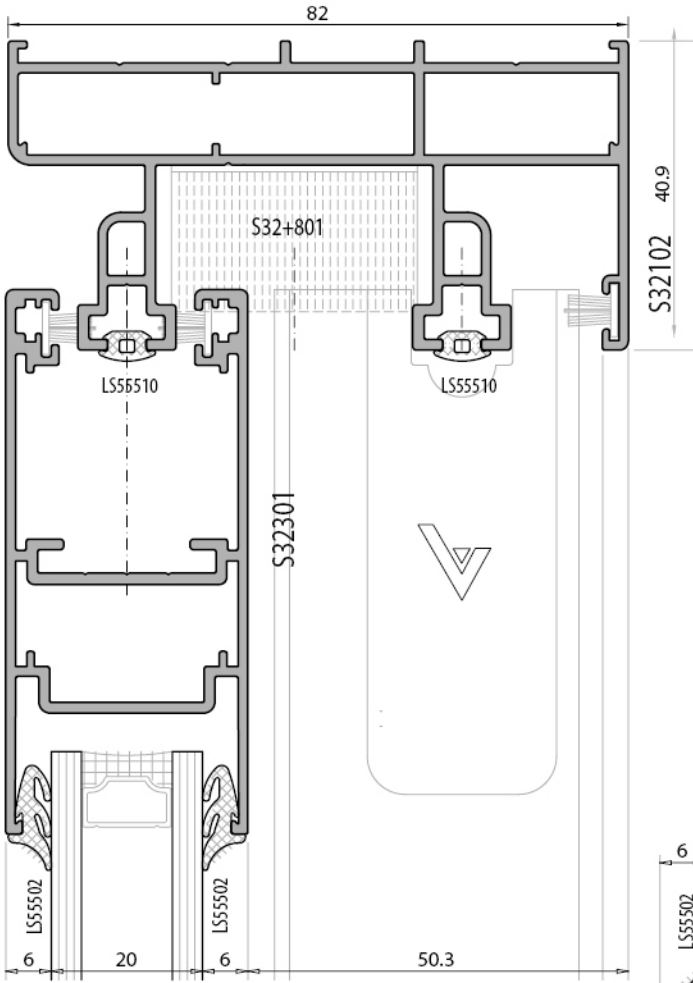

klasik sürme açılım sistem detayı
classical sliding opening system detail

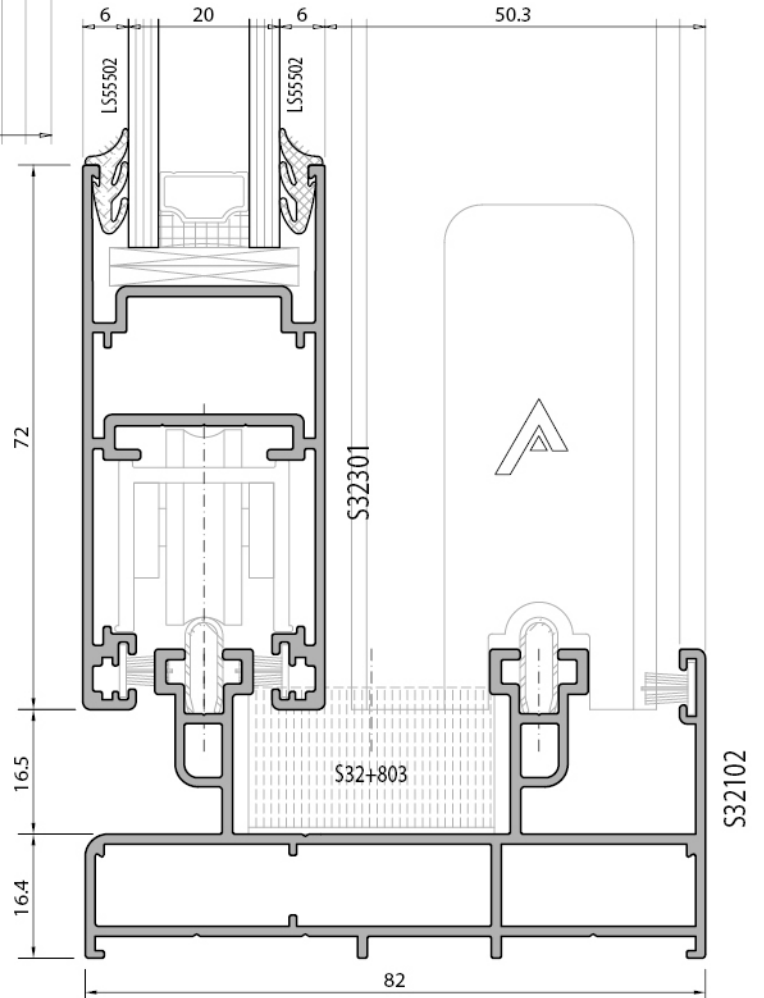

S32 KLASİK SÜRME SİSTEM / CLASSICAL SLIDE SYSTEM
SİSTEM DETAYLARI / SYSTEM DETAILS

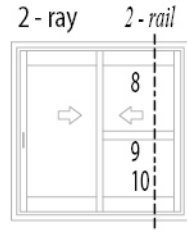
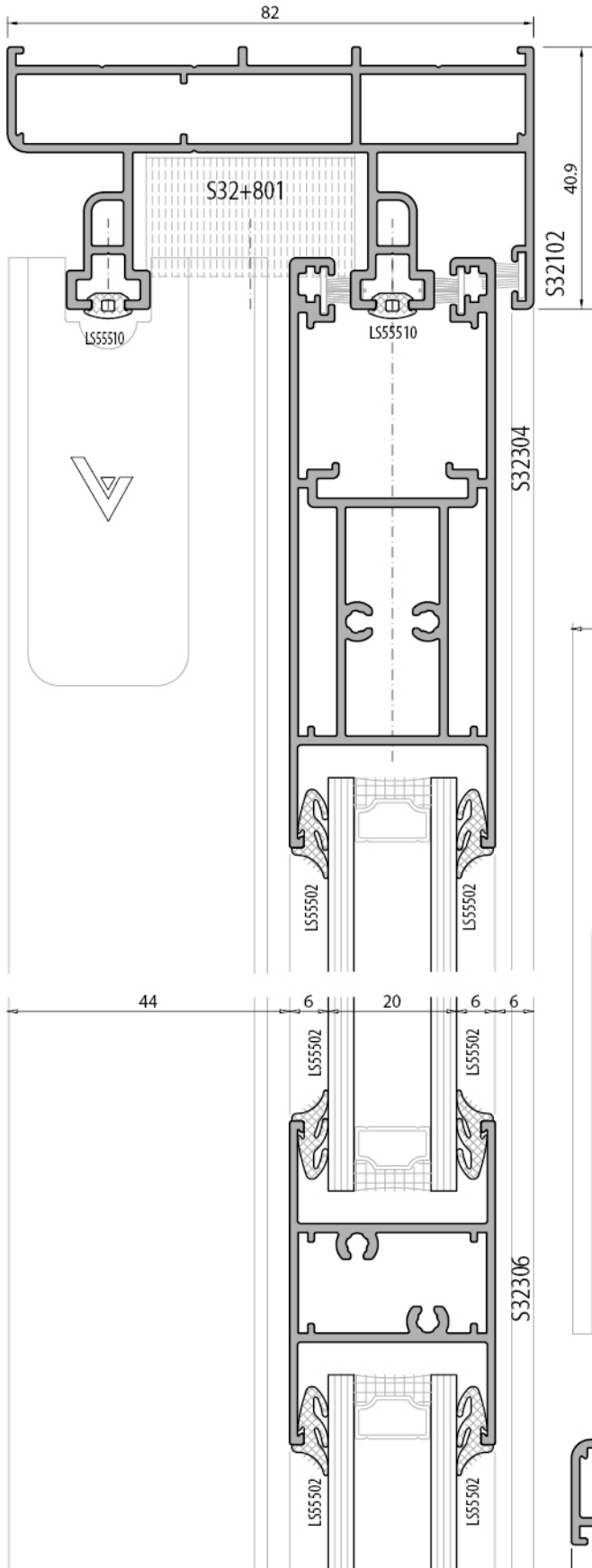

klasik sürme açılım sistem detayı
classical sliding opening system detail

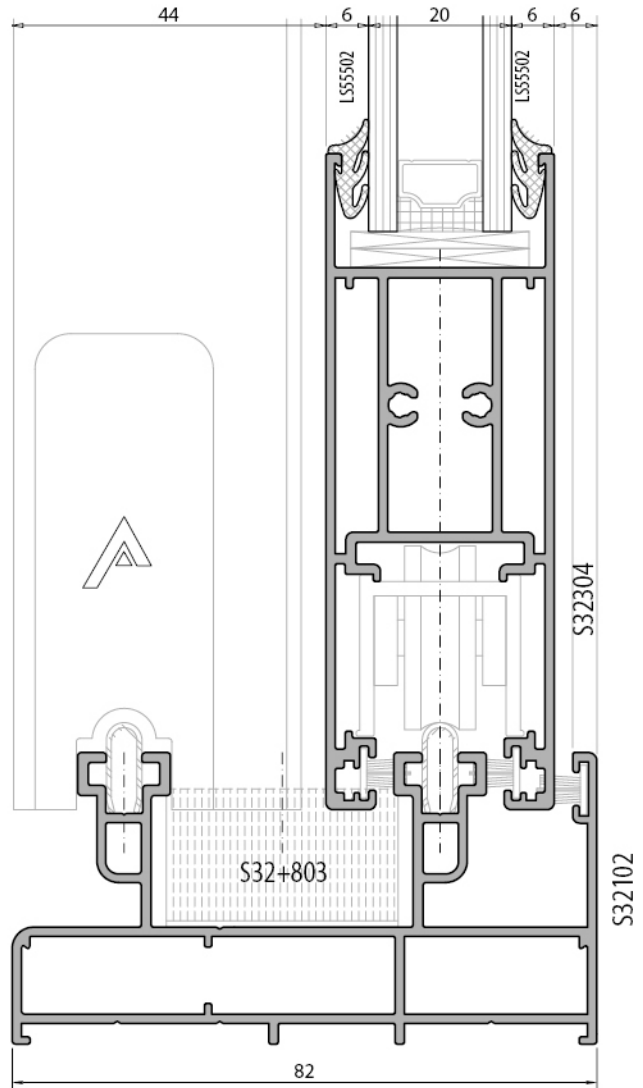

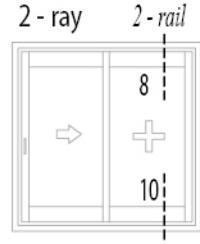
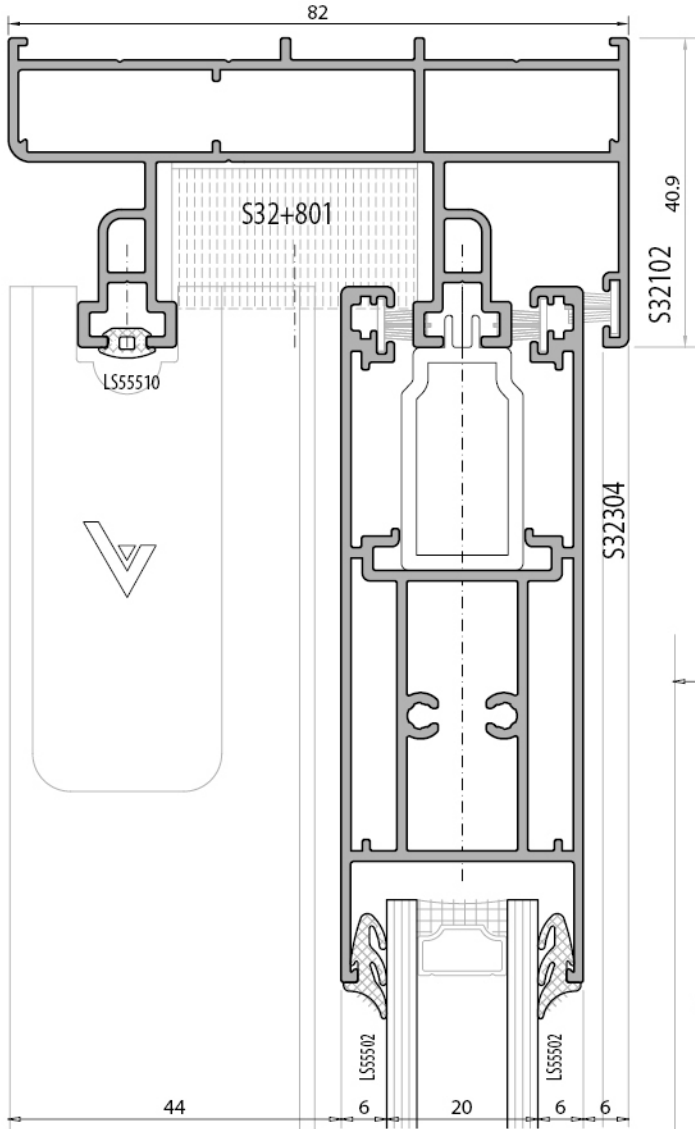

klasik sürme açılım sistem detayı
classical sliding opening system detail

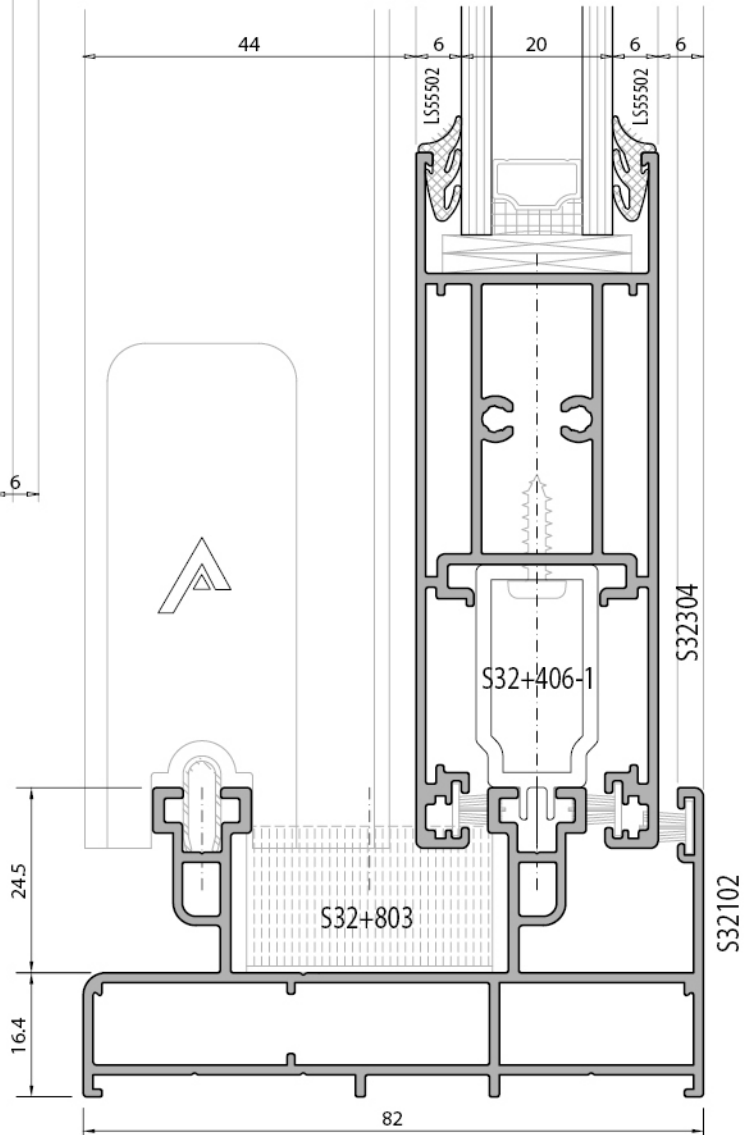

S32 KLASİK SÜRME SİSTEM / CLASSICAL SLIDE SYSTEM

SİSTEM DETAYLARI / SYSTEM DETAILS

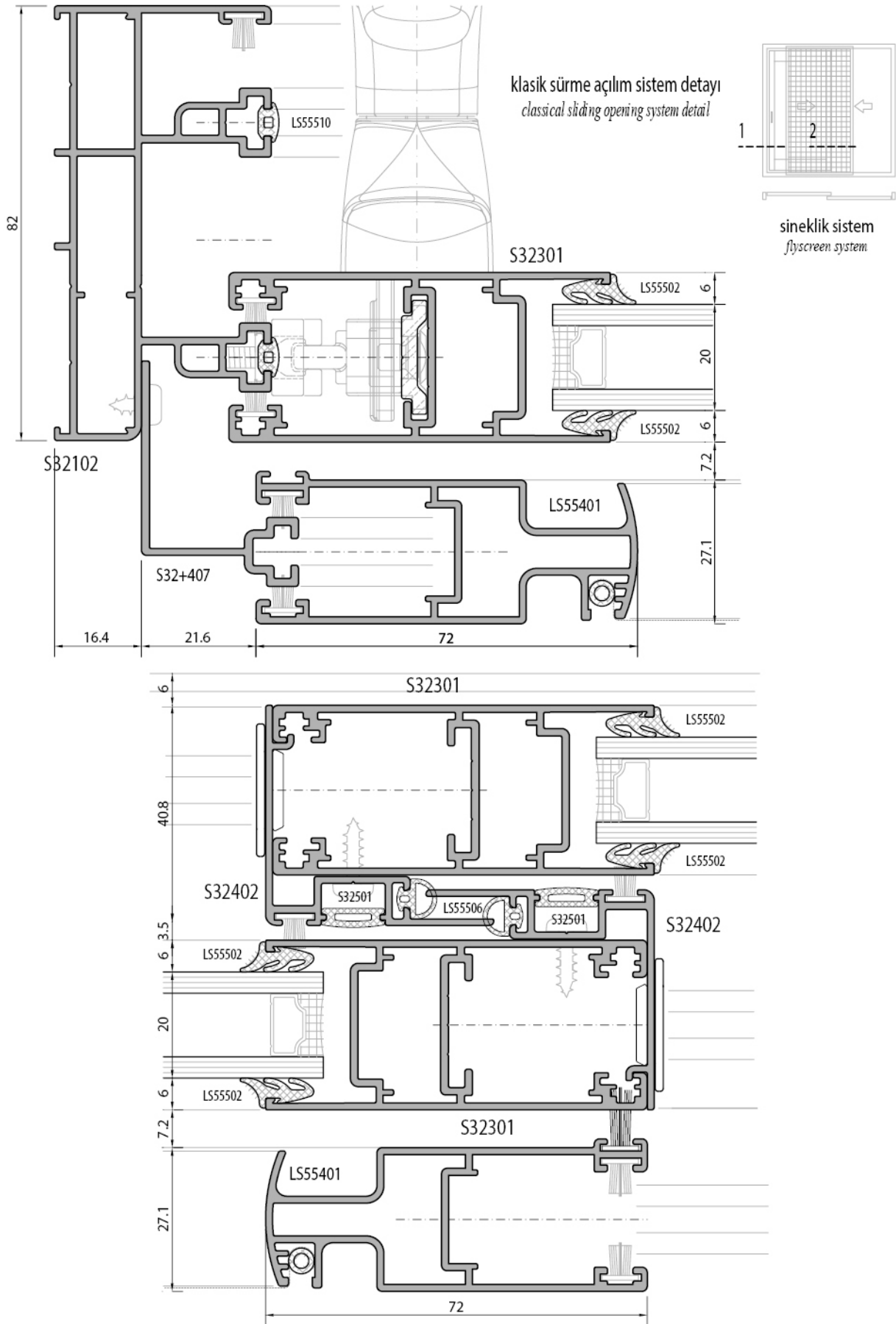

klasik sürme açılım sistem detayı
classical sliding opening system detail

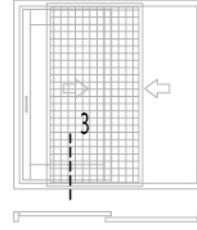

sineklik sistem
flyscreen system

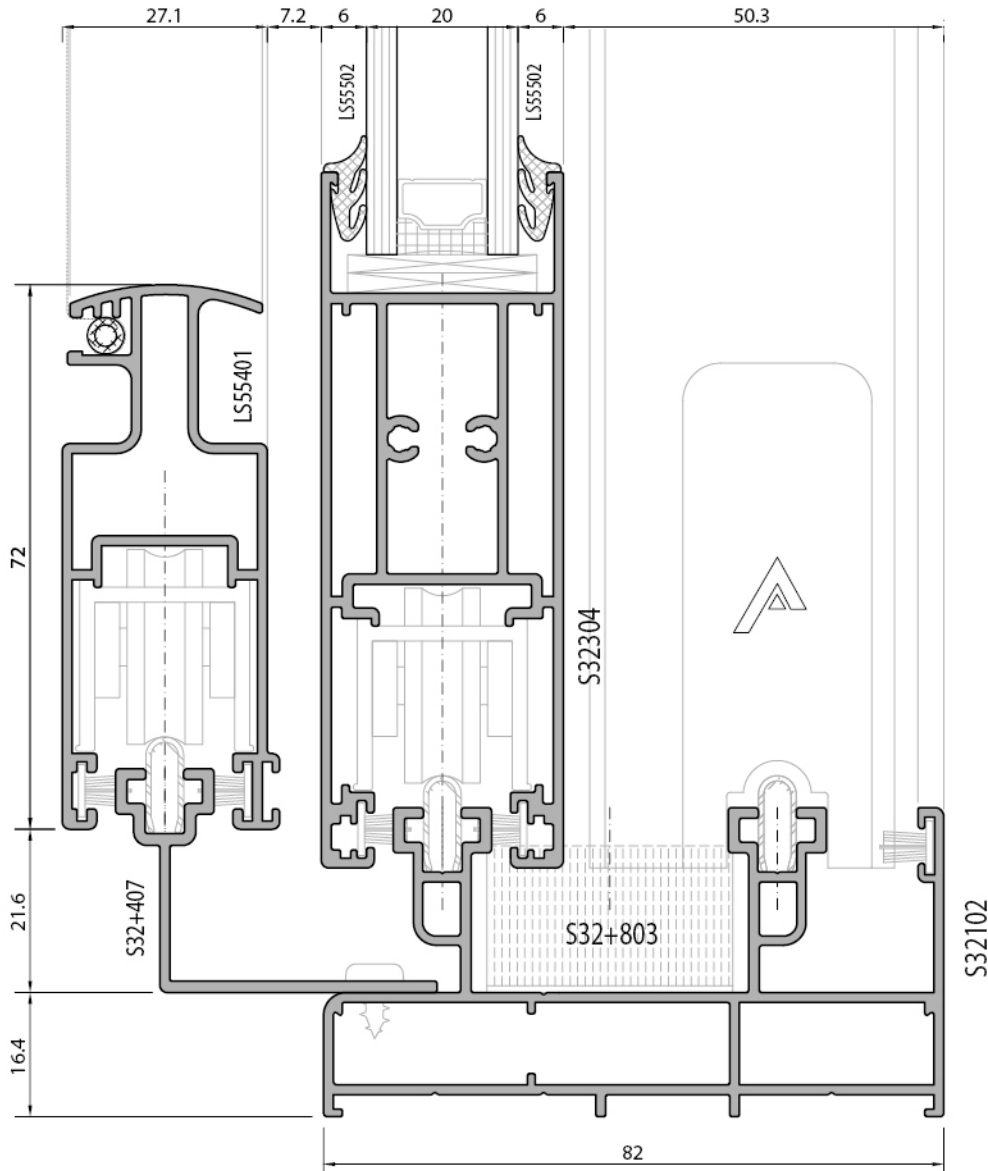

S32 KLASİK SÜRME SİSTEM / CLASSICAL SLIDE SYSTEM

SİSTEM DETAYLARI / SYSTEM DETAILS

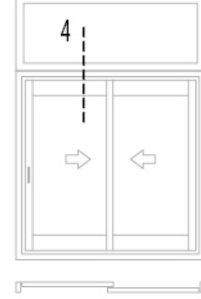
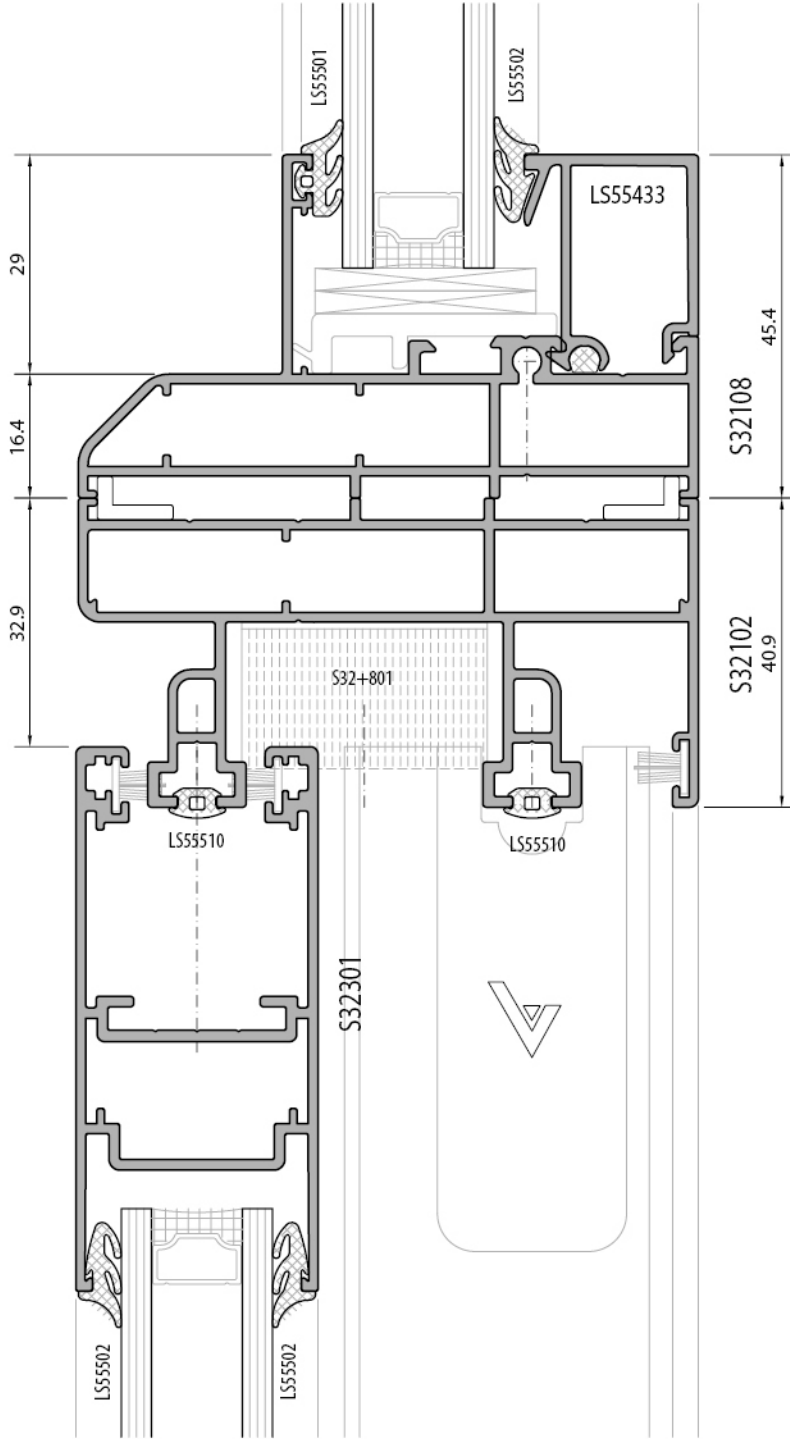

klasik sürme açılım sistem detayı
classical sliding opening system detail

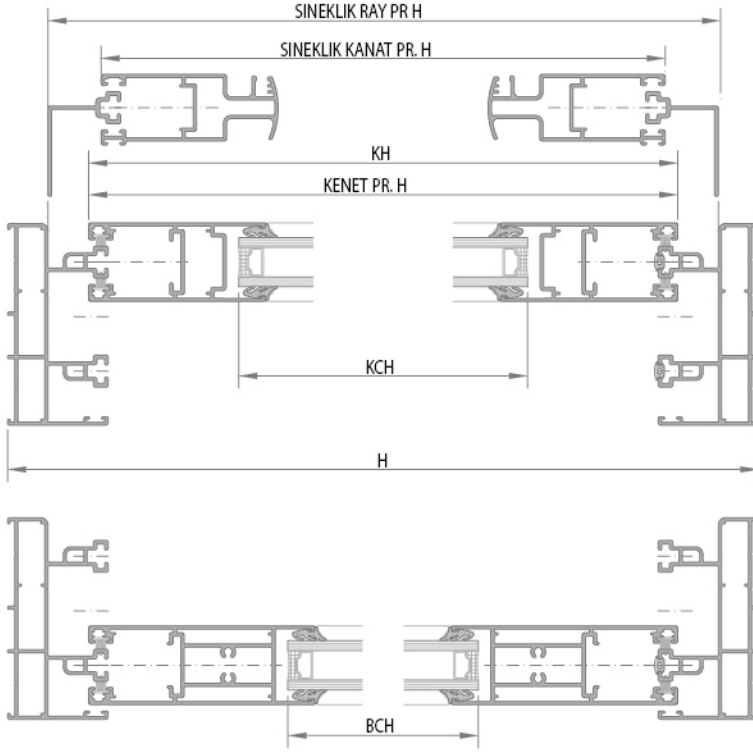

İmalat ve Kesim Planı
Cutting Dimensions

Sürme Eni	: L
sürme Yüksekliği	: H
Kanat Eni	: KL
Baza Kanat Eni	: BKL
Kanat Yüksekliği	: KH
Kanat Cam Eni	: KCL
Kanat Cam Yük	: KCH
Baza Kanat Cam Yük.	: BCH
Kanat Çita Eni	: K.Çita L
Kanat Çita Yük.	: K.Çita H
Kenet Profili H	: H-66
Sineklük Ray Profili L	: L-33
Sineklük Ray Profili H	: H-33
Sineklük Kanat Profili L	: L/2+2
Sineklük Kanat Profili H	: H-66

* Hesap yöntemi camların eşit olma esasına göre yapılmıştır.
The calculation method was made on the basis of the equality of the glasses.

KLASİK SÜRME AÇILIM
CLASSICAL SLIDING OPENING

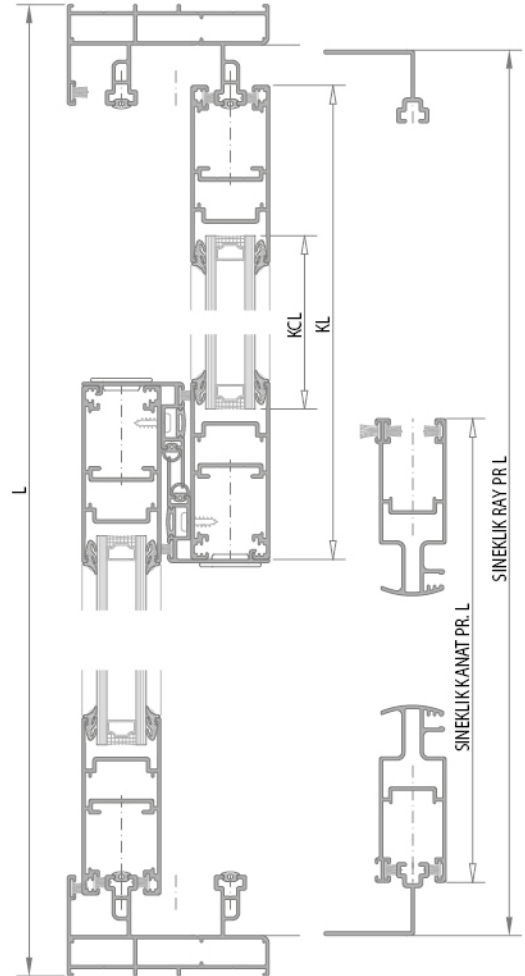
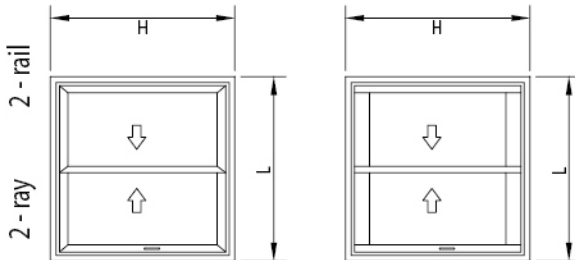

KLASİK SÜRME AÇILIM
CLASSICAL SLIDING OPENING

2 - ray 2 - raiil

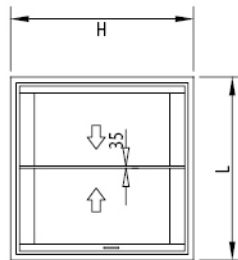
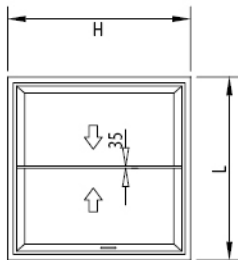

İmalat ve Kesim Planı

Cutting Dimensions

Sürme Eni	: L
sürme Yüksekliği	: H
Kanat Eni	: KL
Baza Kanat Eni	: BKL
Kanat Yüksekliği	: KH
Kanat Cam Eni	: KCL
Kanat Cam Yüksekliği	: KCH
Baza Kanat Cam Yüksekliği	: BCH
Kanat Çıta Eni	: K.Cıta L
Kanat Çıta Yüksekliği	: K.Cıta H
Kanat Profili H	: H - 66
İnce Kanat Profili H	: H - 66

* Hesap yöntemi camların eşit olma esasına göre yapılmıştır.
The calculation method was made on the basis of the equality of the glasses.

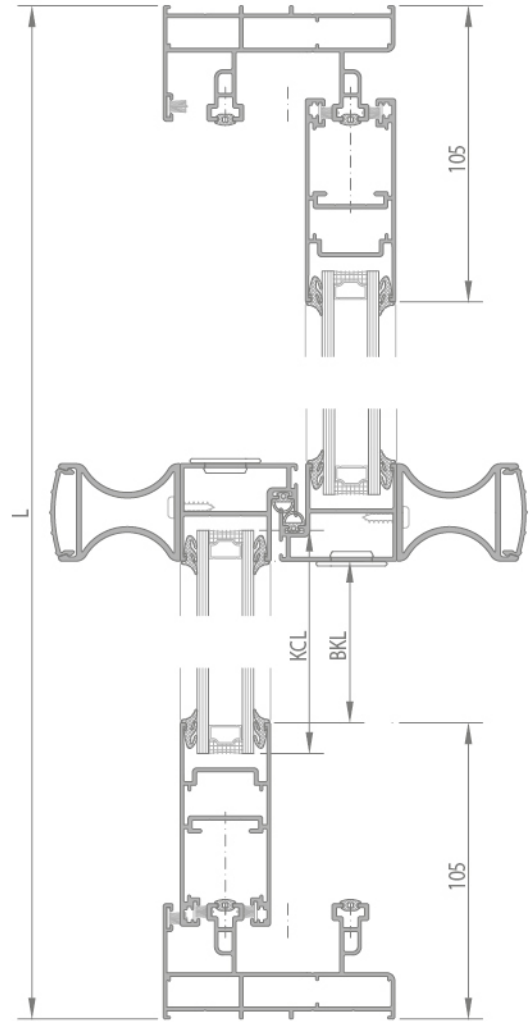
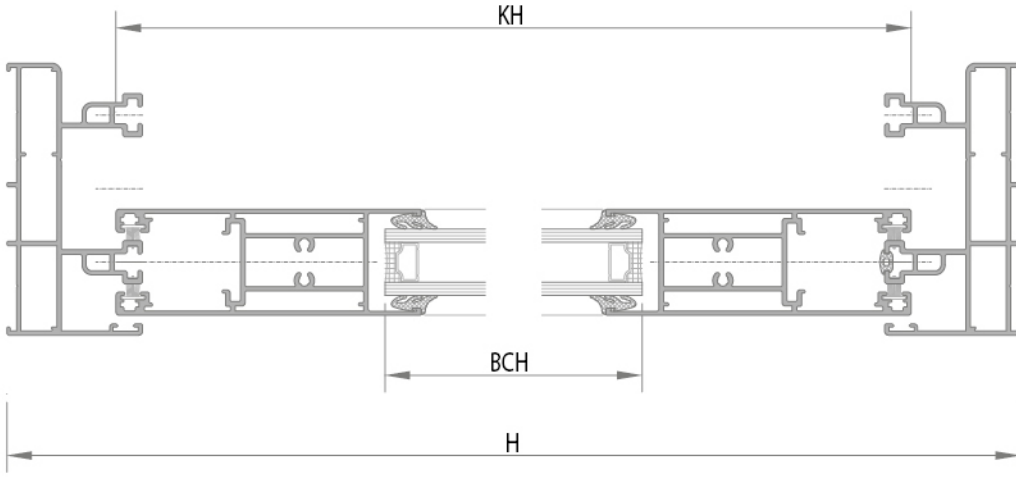

KLASİK SÜRME AÇILIM
CLASSICAL SLIDING OPENING

2 - ray 2 - rail

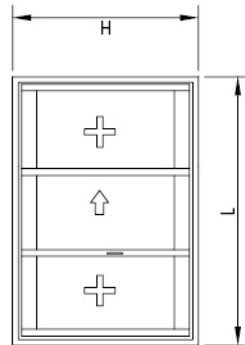
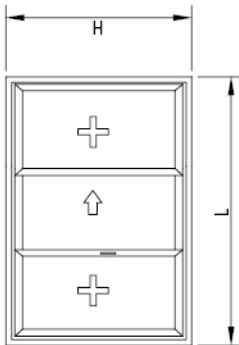

İmalat ve Kesim Planı
Cutting Dimensions

Sürme Eni	: L
sürme Yüksekliği	: H
Kanat Eni	: KL
Baza Kanat Eni	: BKL
Kanat Yüksekliği	: KH
Kanat Cam Eni	: KCL
Kanat Cam Yük	: KCH
Baza Kanat Cam Yük.	: BCH
Kanat Çita Eni	: K.Cita L
Kanat Çita Yük.	: K.Cita H
Kenet Profili H	: H - 66
Sabit Kanat Kenet Pr. H:	H - 33

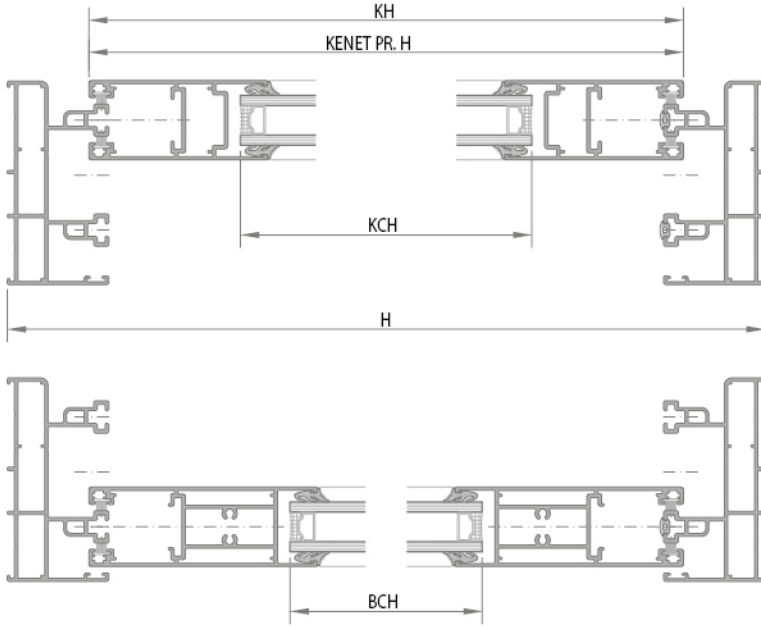

* Hesap yöntemi camların eşit olma esasına göre yapılmıştır.
The calculation method was made on the basis of the equality of the glasses.

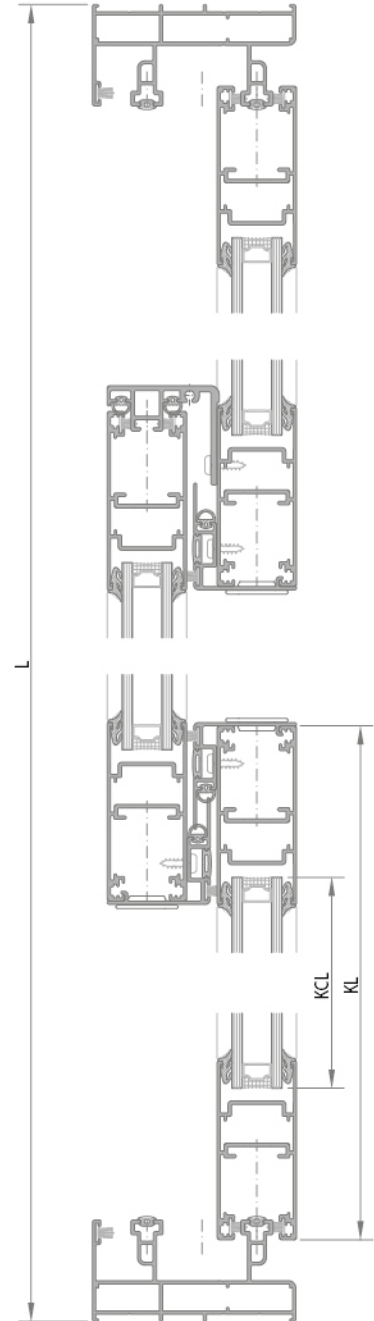

KLASİK SÜRME AÇILIM
CLASSICAL SLIDING OPENING

2 - ray 2 - rail

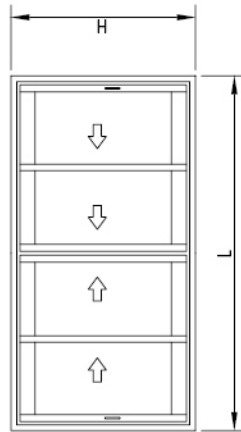
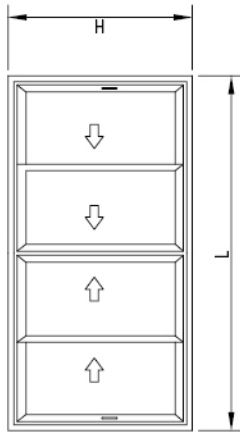

İmalat ve Kesim Planı
Cutting Dimensions

Sürme Eni	: L
sürme Yüksekliği	: H
Kanat Eni	: KL
Baza Kanat Eni	: BKL
Kanat Yüksekliği	: KH
Kanat Cam Eni	: KCL
Kanat Cam Yük	: KCH
Baza Kanat Cam Yük	: BCH
Kanat Çita Eni	: K-Cıta L
Kanat Çita Yük.	: K-Cıta H
Kenet Profili H	: H - 66
Kanat BirL. Adap. H	: KH - 29

* Hesap yöntemi camların eşit olma esasına göre yapılmıştır.

The calculation method was made on the basis of the equality of the glasses.

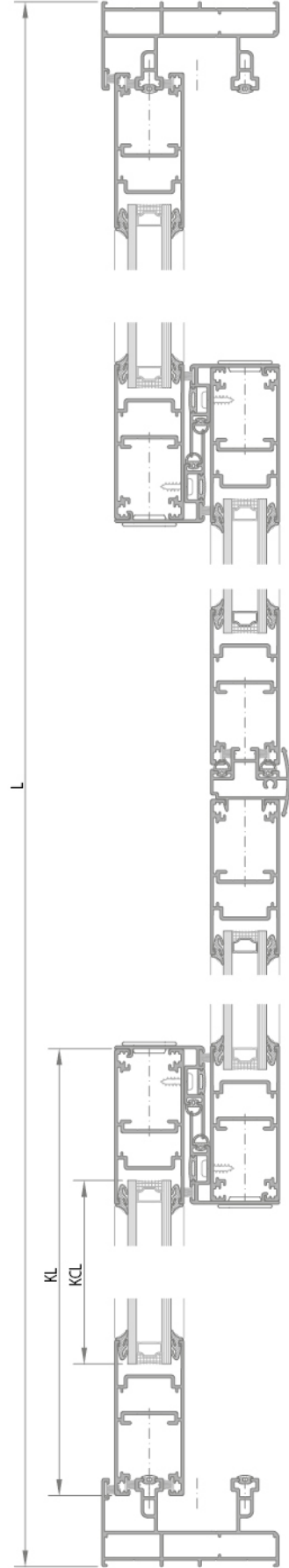
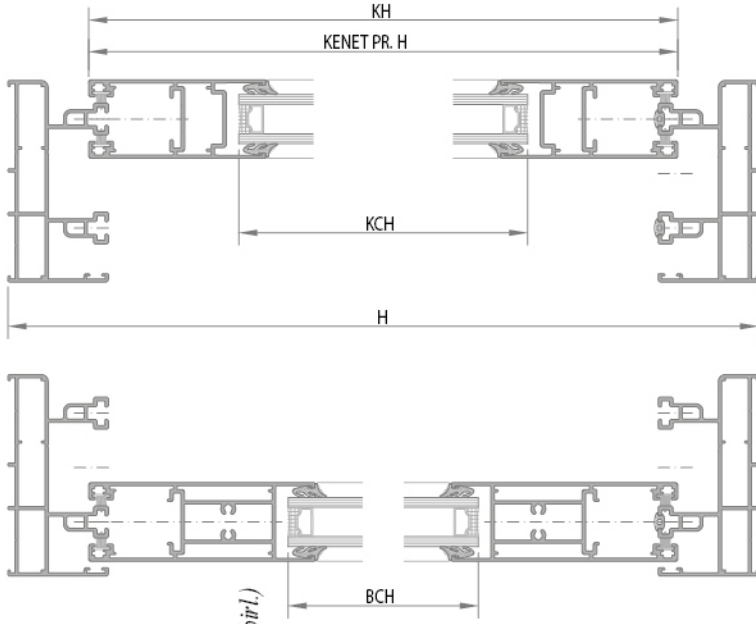

3 - RAY PROFİL SİSTEMİ

3 - RAIL PROFILE SYSTEM

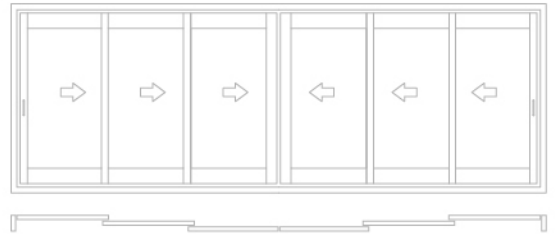
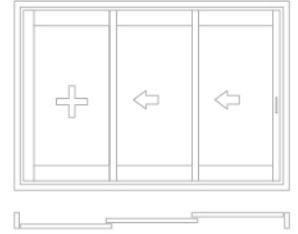
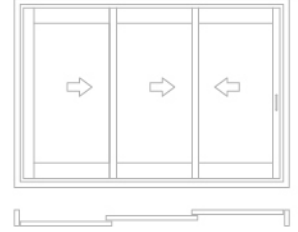
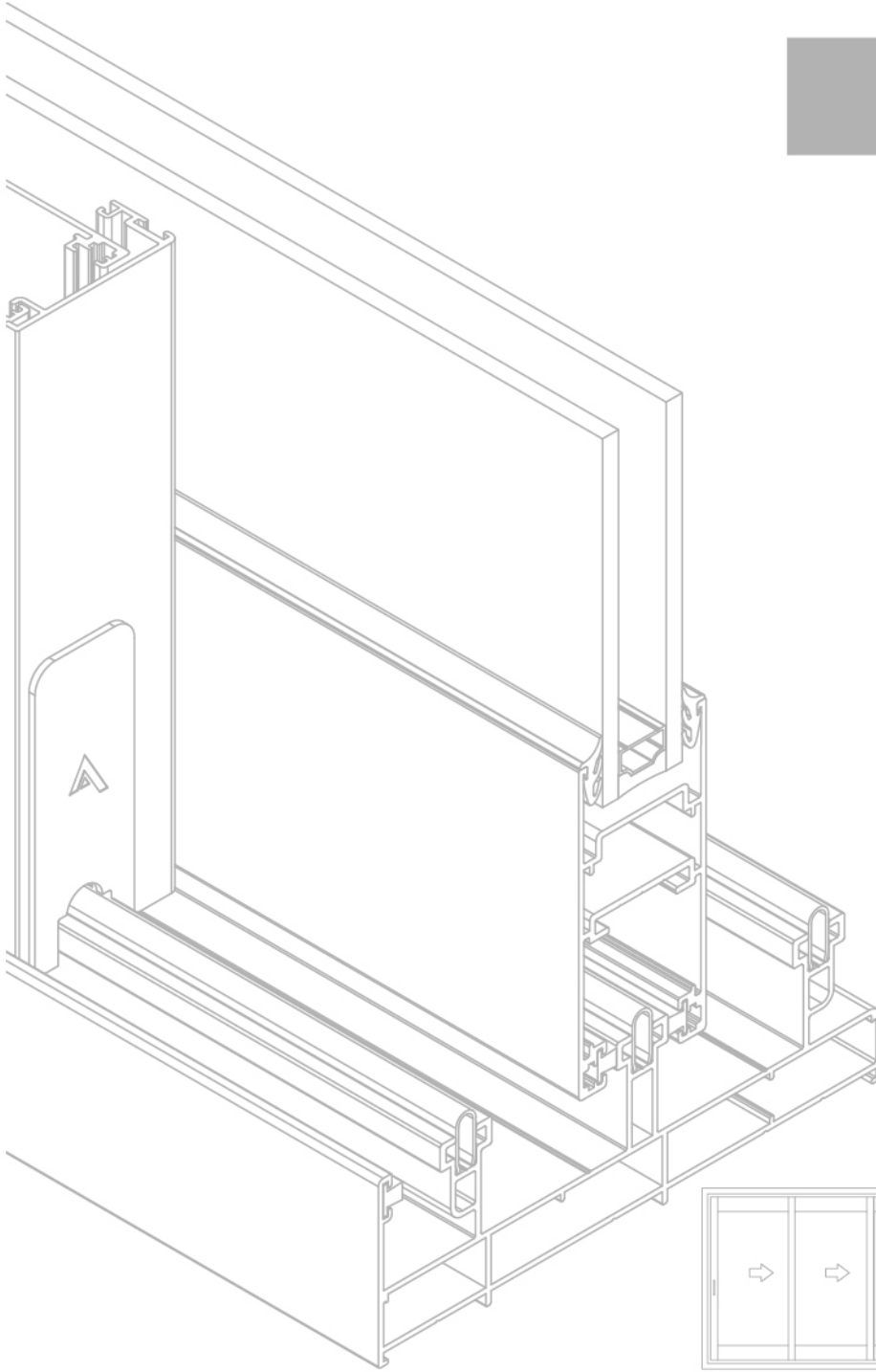

S32 KLASİK SÜRME SİSTEM / CLASSICAL SLIDE SYSTEM

SİSTEM DETAYLARI / SYSTEM DETAILS

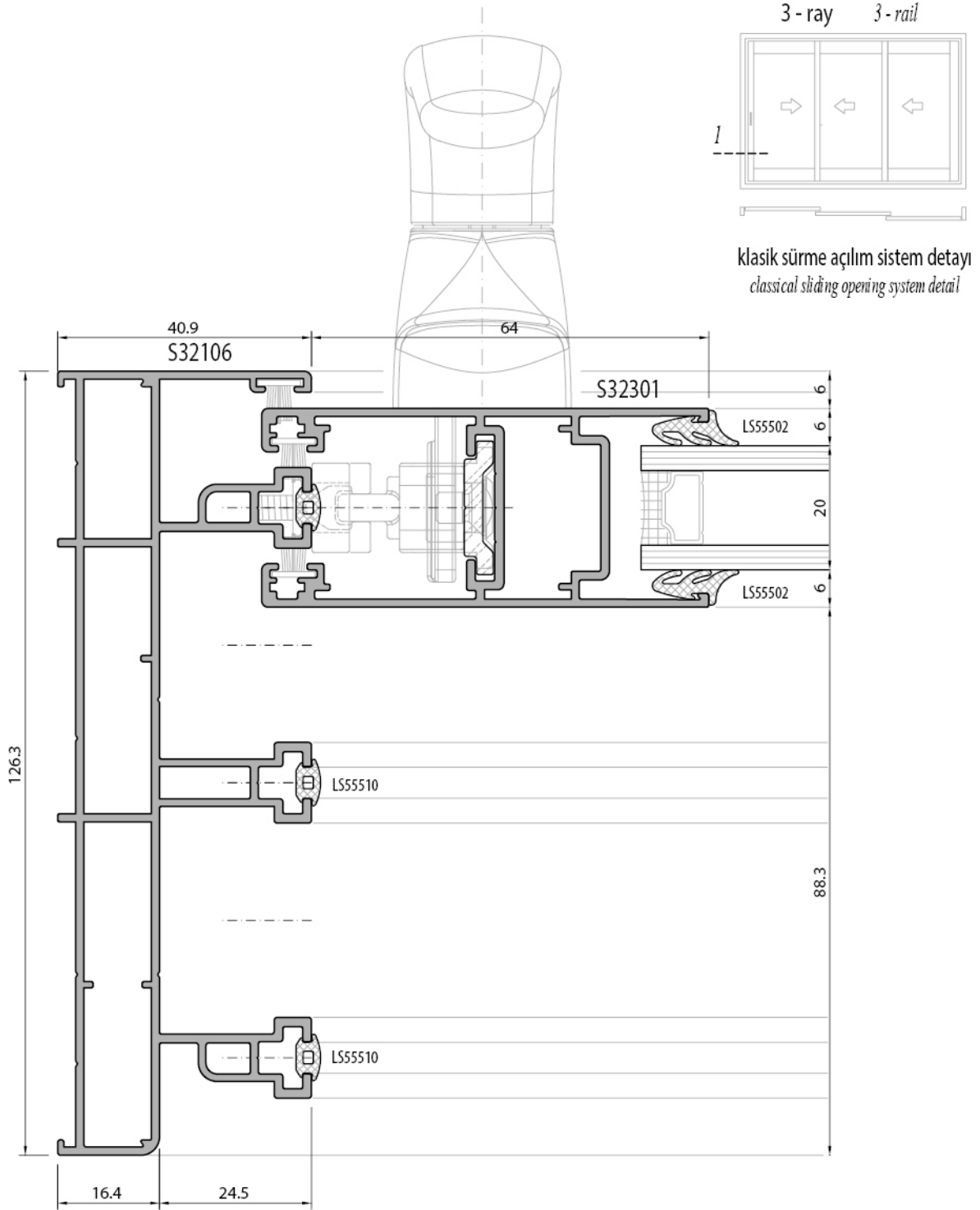

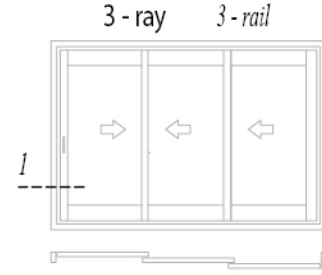

klasik sürme açılım sistemi detayı
classical sliding opening system detail

cam çıtalı alternatif
glazing bead alternative

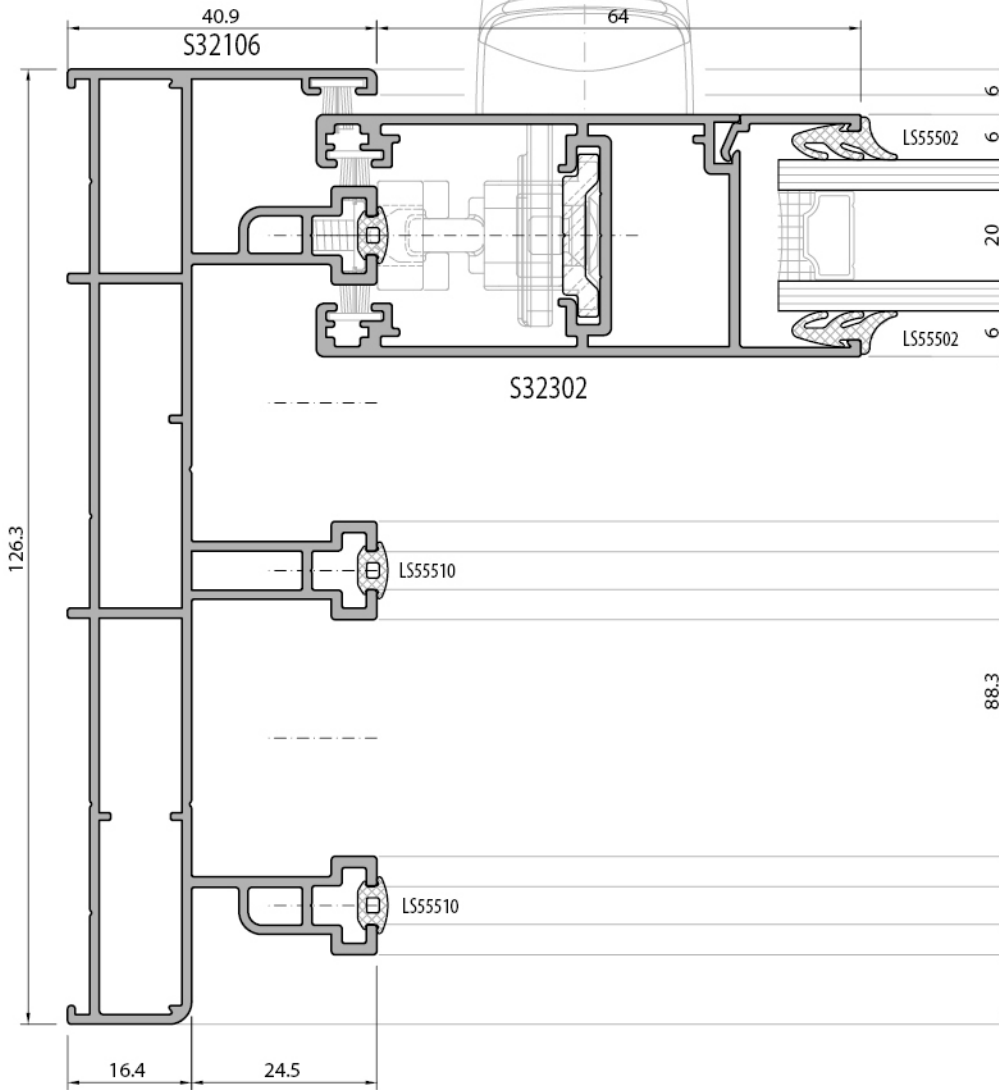

klasik sürme açılım sistem detayı
classical sliding opening system detail

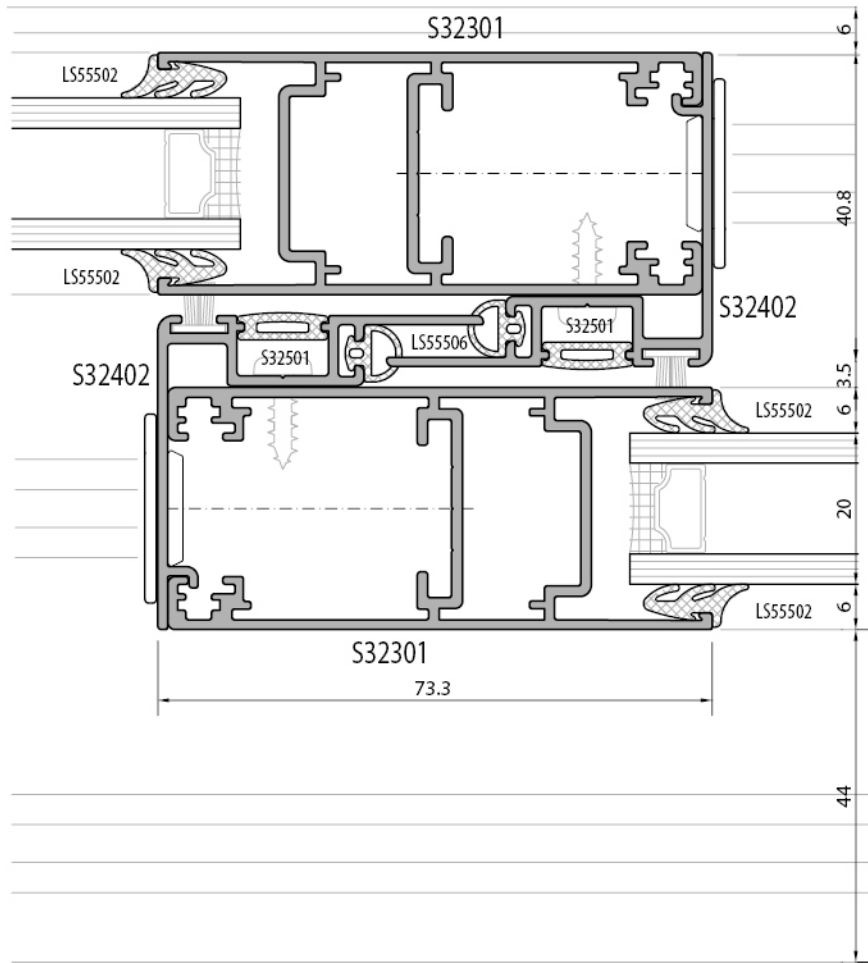
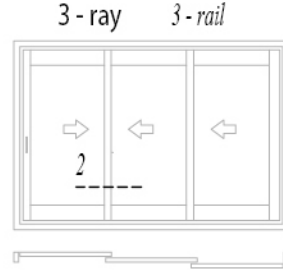

klasik sürme açılım sistem detayı
classical sliding opening system detail

3 - ray 3 - rail



cam çıtalı alternatif
glazing bead alternative

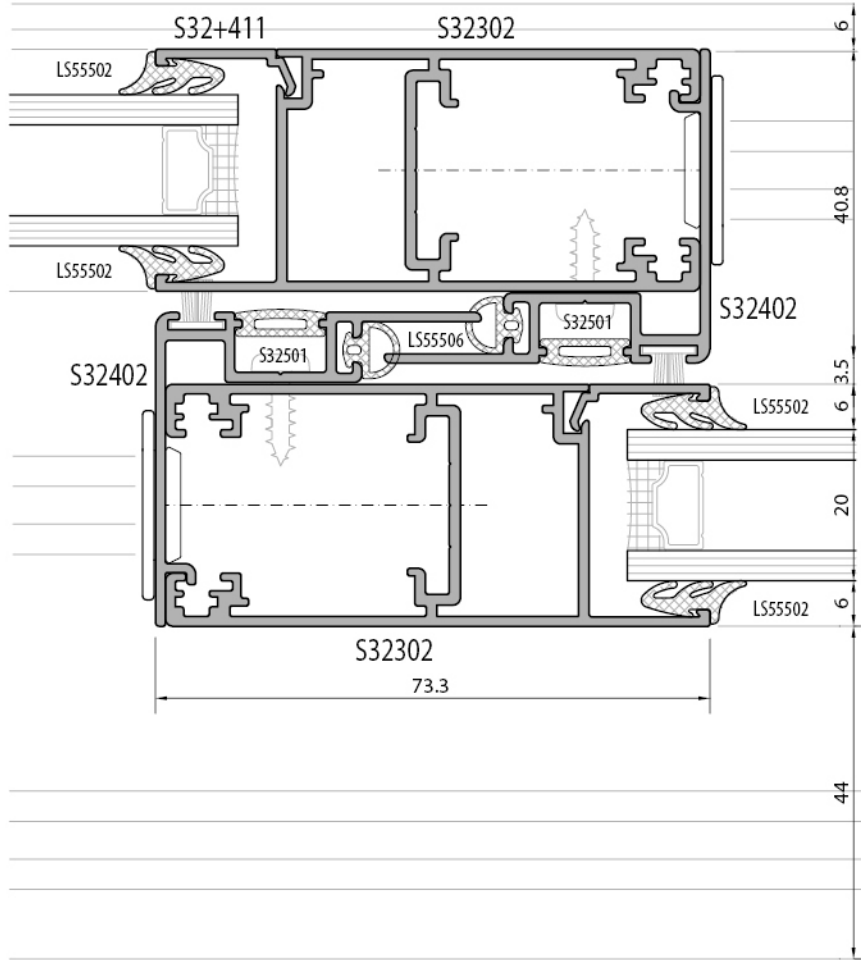

klasik sürme açılım sistem detayı
classical sliding opening system detail

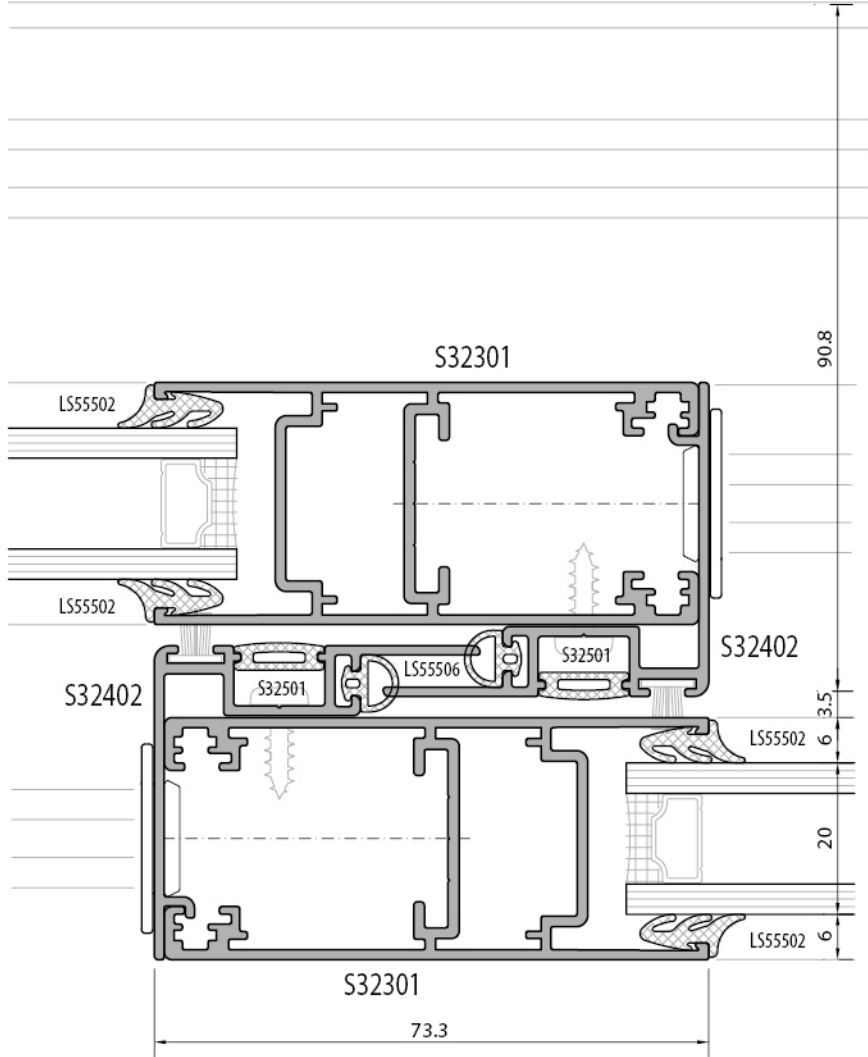
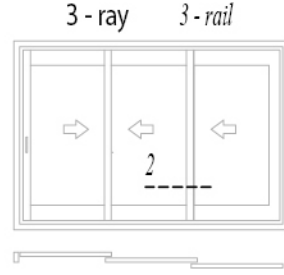

klasik sürme açılım sistem detayı
classical sliding opening system detail

3 - ray 3 - rail

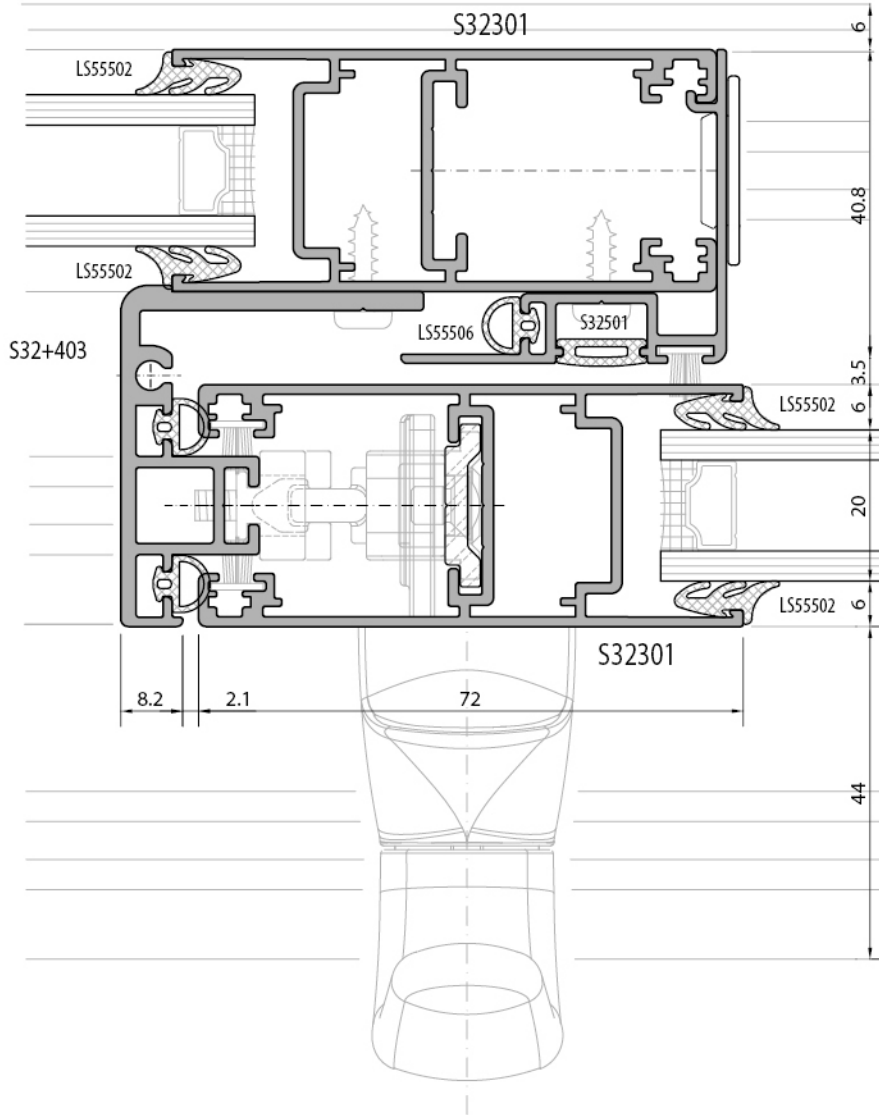
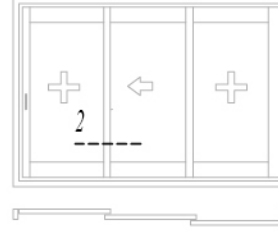

klasik sürme açılım sistem detayı
classical sliding opening system detail

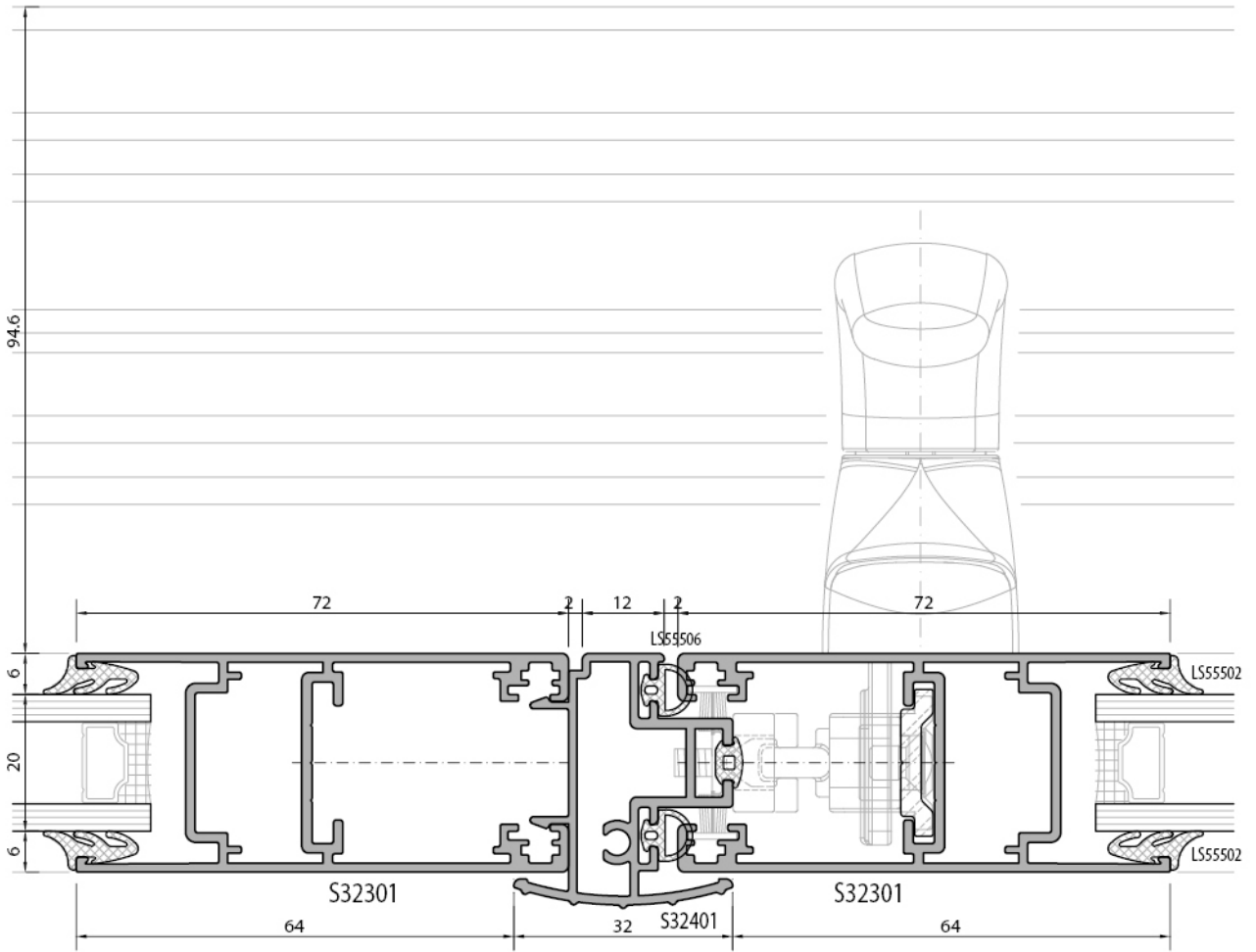
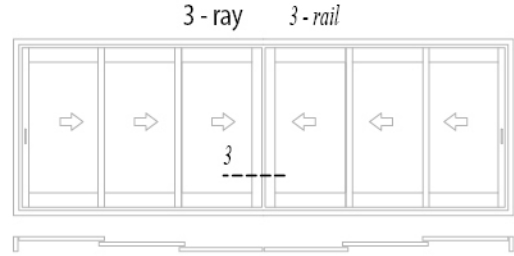

klasik sürme açılım sistem detayı
classical sliding opening system detail

3 - ray 3 - rail

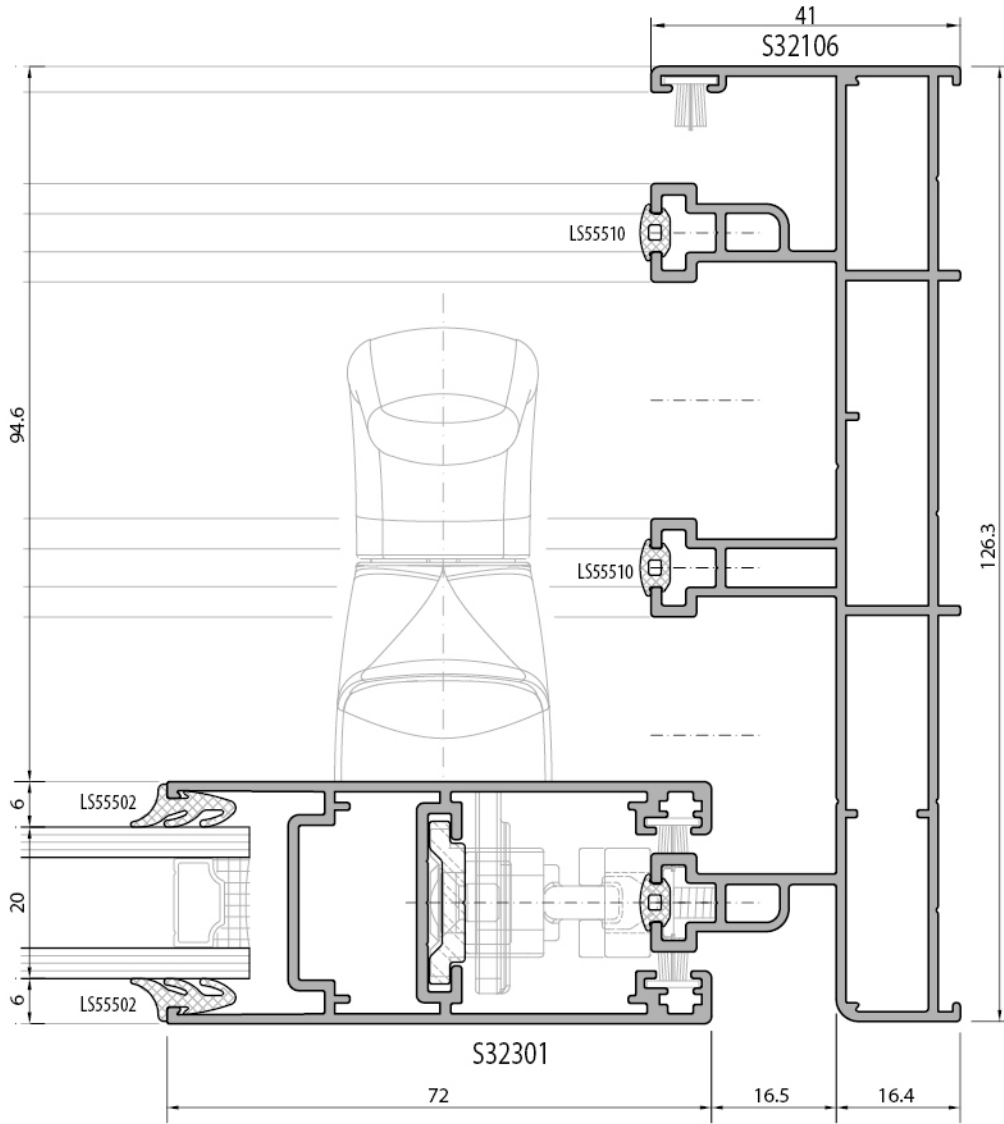
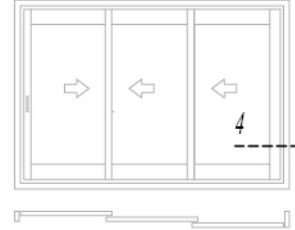

klasik sürme açılım sistemi detayı
classical sliding opening system detail

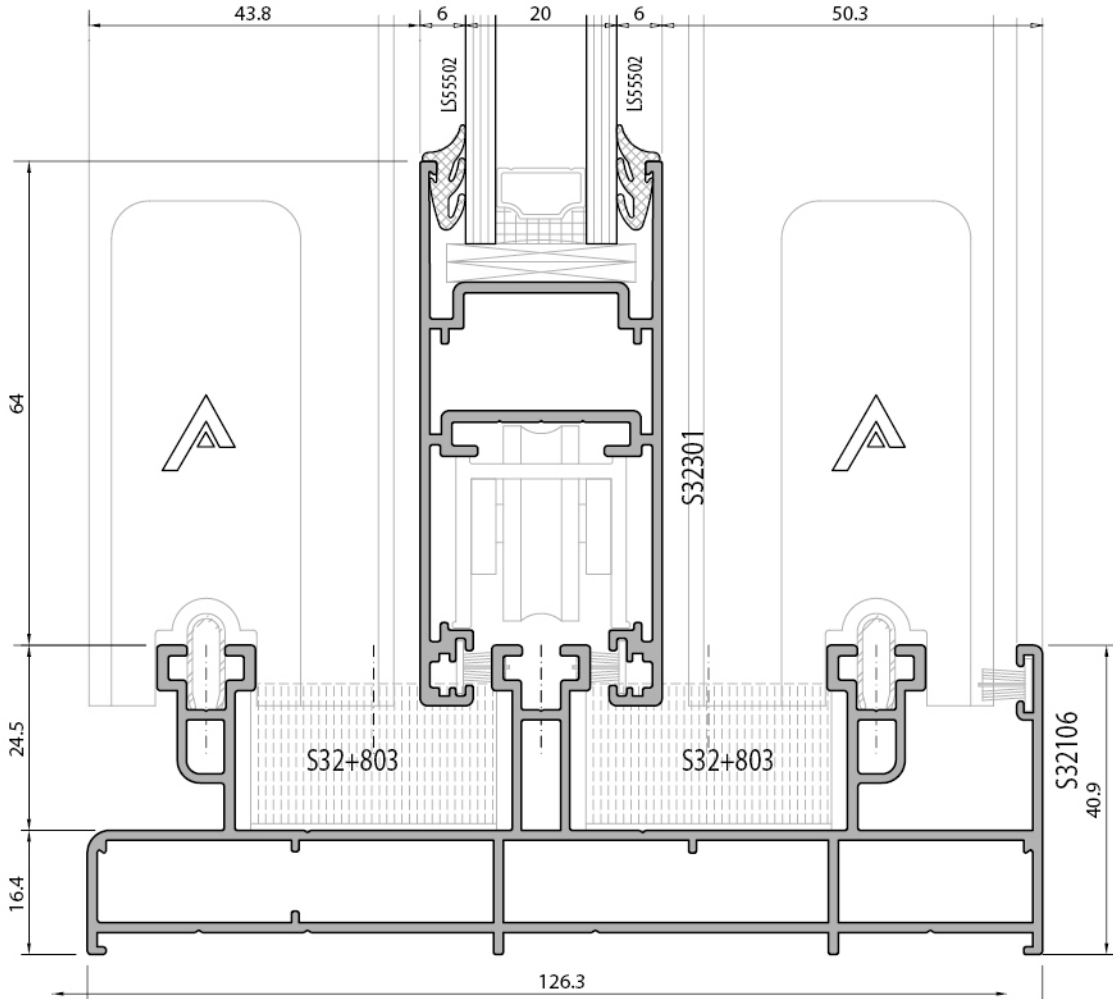
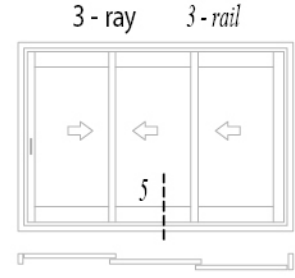

klasik sürme açılım sistem detayı
classical sliding opening system detail

3 - ray 3 - rail

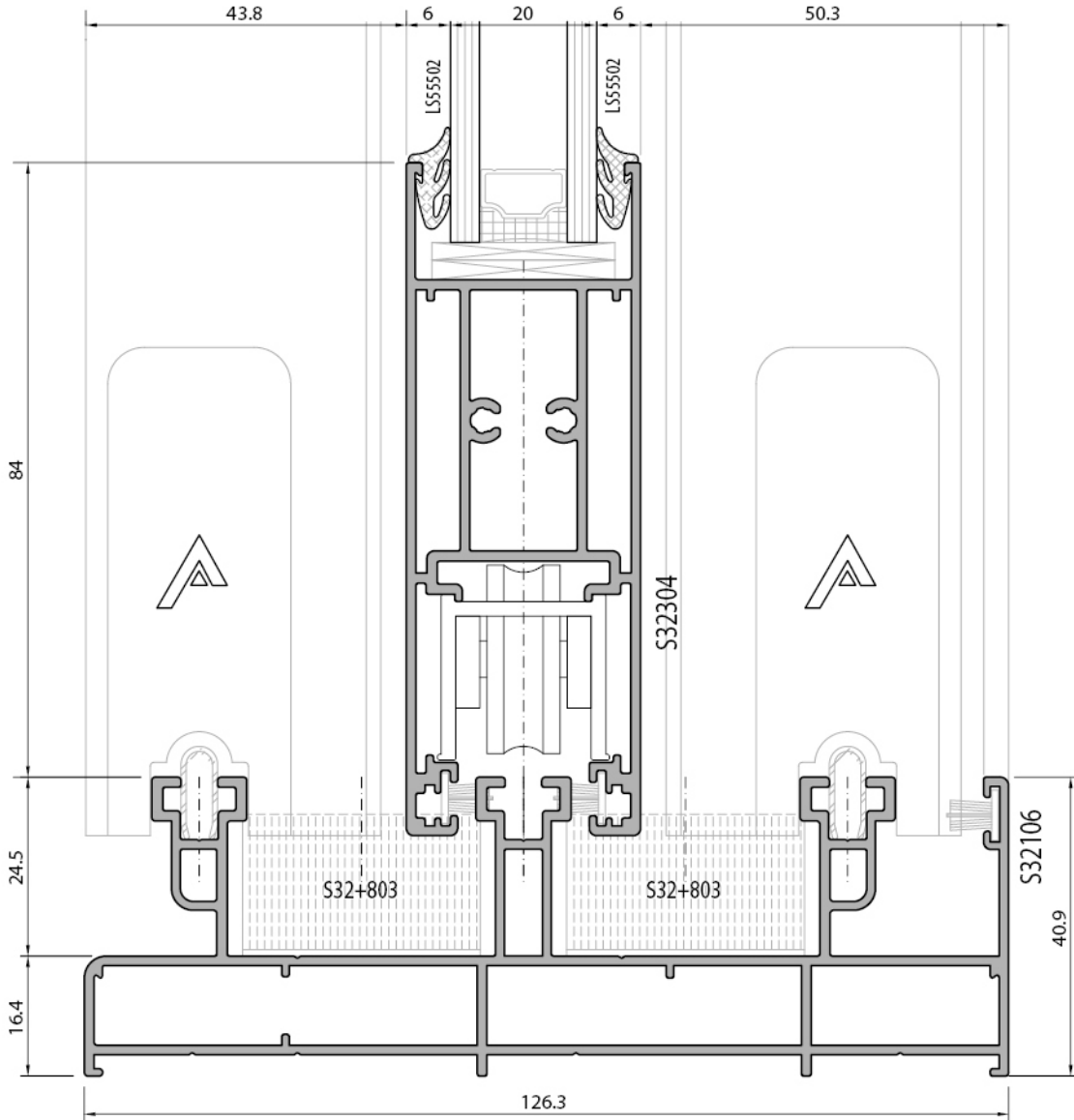
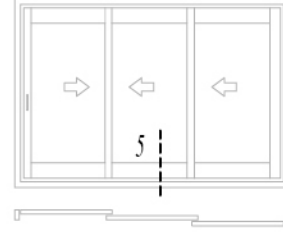

S32 KLASİK SÜRME SİSTEM / CLASSICAL SLIDE SYSTEM
SİSTEM DETAYLARI / SYSTEM DETAILS

klasik sürme açılım sistem detayı
classical sliding opening system detail

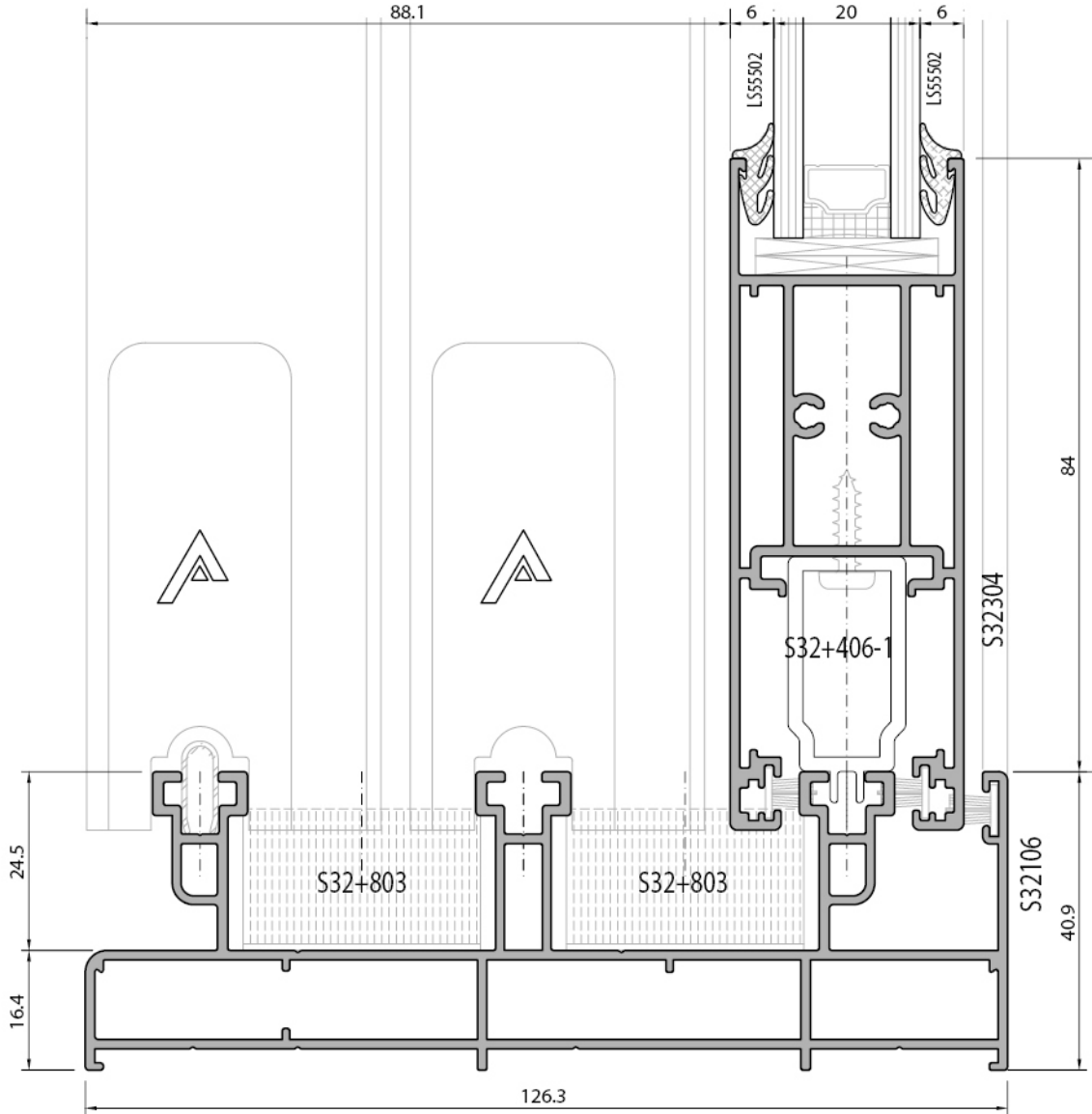
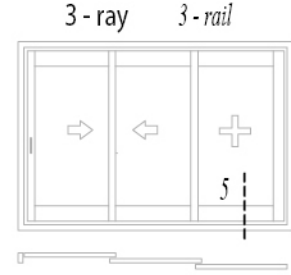

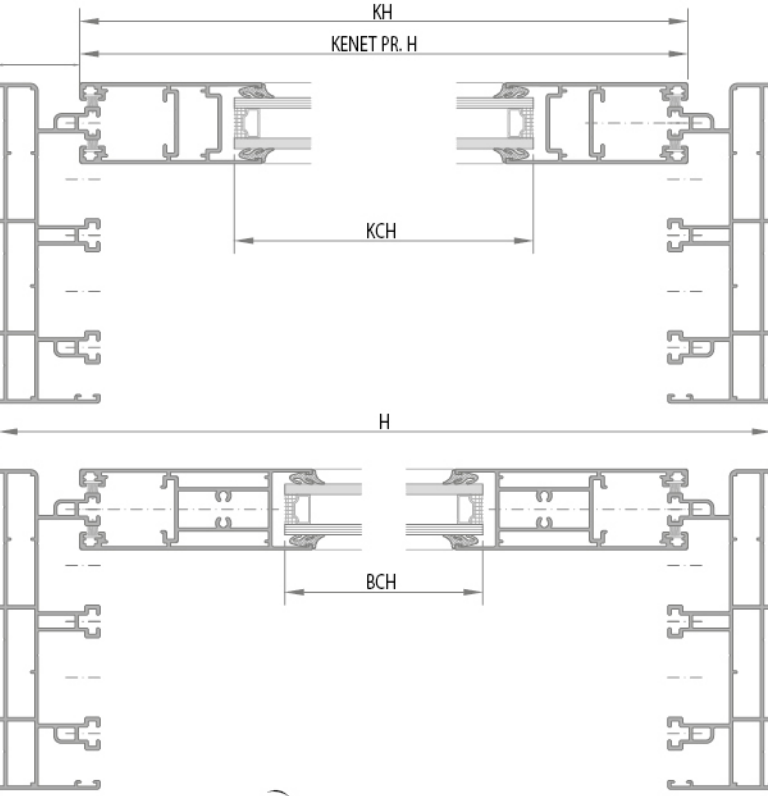

İmalat ve Kesim Planı
Cutting Dimensions

Sürme Eni	: L
sürme Yüksekliği	: H
Kanat Eni	: KL
Baza Kanat Eni	: BKL
Kanat Yüksekliği	: KH
Kanat Cam Eni	: KCL
Baza Kanat Cam Yüksekliği	: KCH
Kanat Cam Yüksekliği	: BCH
Kanat Çıta Eni	: K.Cıta L
Kanat Çıta Yüksekliği	: K.Cıta H
Kenat Profili H	: H - 66

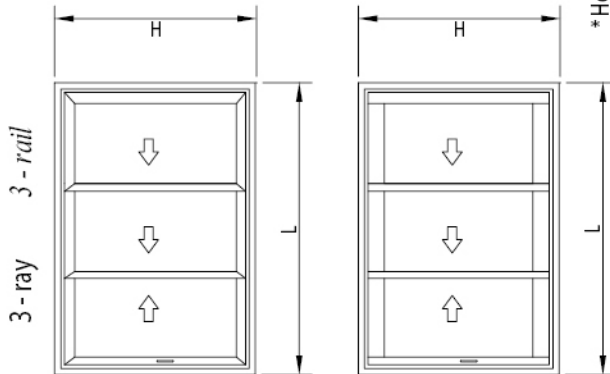

* Hesap yöntemi camların eşit olma esasına göre yapılmıştır.
The calculation method was made on the basis of the equality of the glasses.

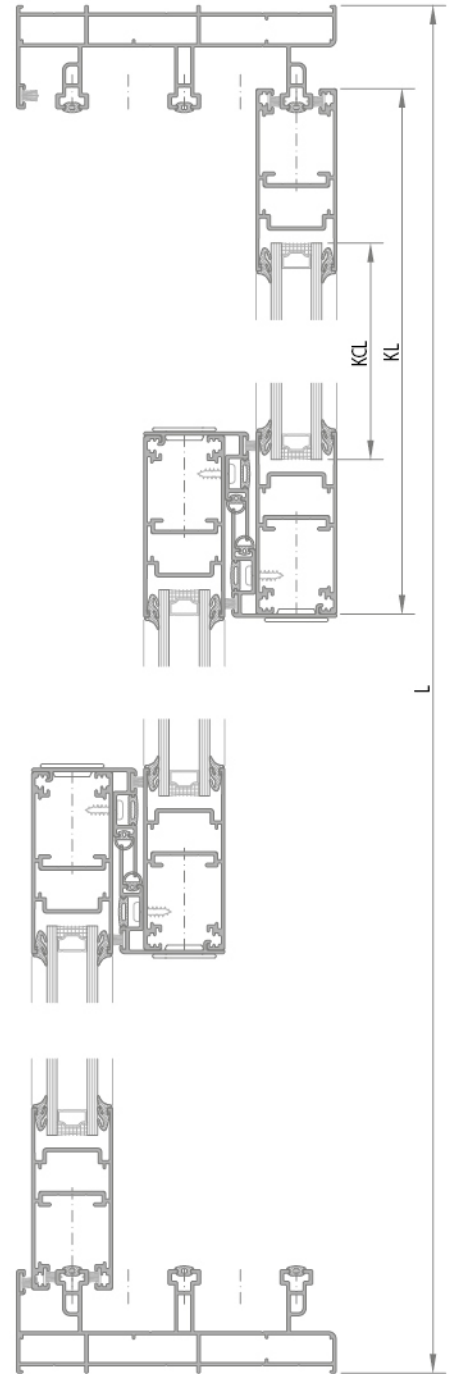

KLASİK SÜRME AÇILIM
CLASSICAL SLIDING OPENING

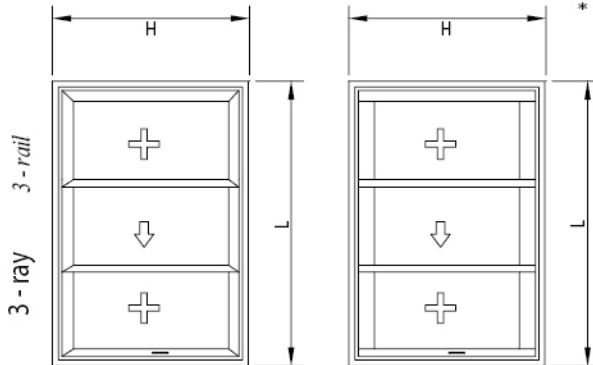

İmalat ve Kesim Planı
Cutting Dimensions

Sürme Eni	: L
sürme Yüksekliği	: H
KanatEni	: KL
Baza Kanat Eni	: BKL
Kanat Yüksekliği	: KH
Kanat Cam Eni	: KCL
Kanat Cam Yük	: KCH
Baza Kanat Cam Yük	: BCH
Kanat Çıta Eni	: K.Cıta L
Kanat Çıta Yük.	: K.Cıta H
Kenet Profili H	: H - 66
Sabit Kanat Kenet Pr. H:	H - 33

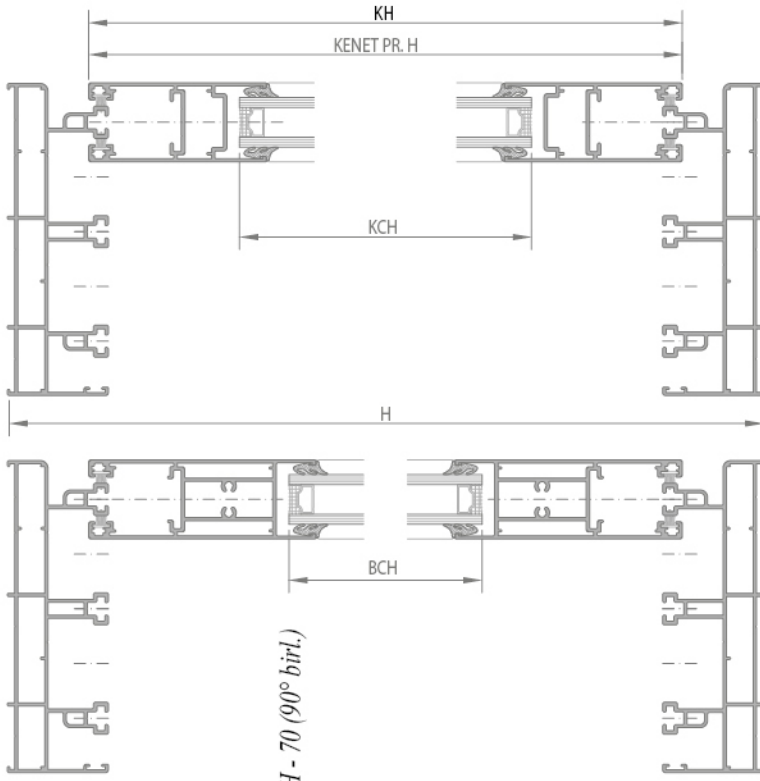

H - 66 (45° birli.) H - 70 (90° birli.)

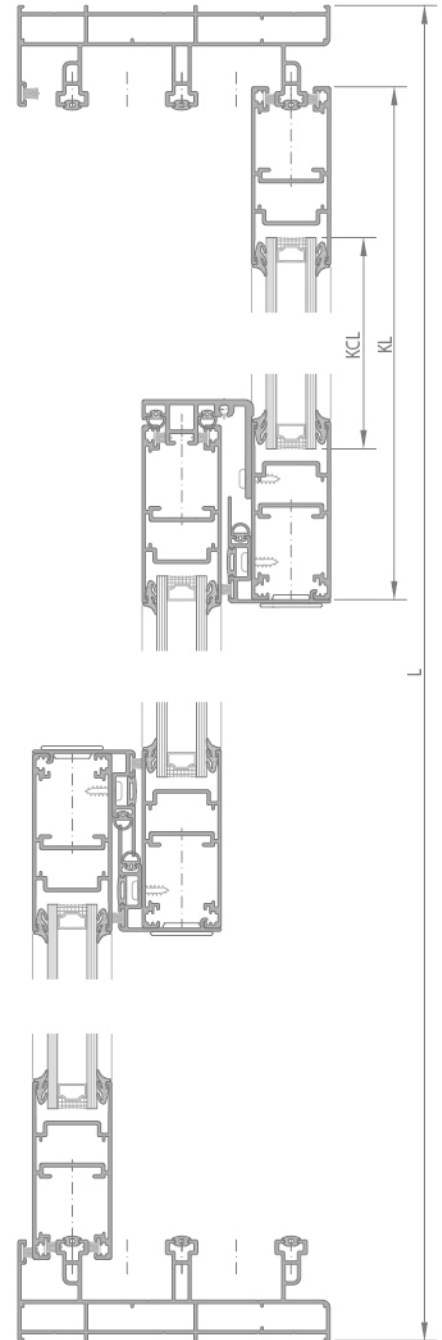

* Hesap yöntemi camların eşit olma esasına göre yapılmıştır.
The calculation method was made on the basis of the equality of the glasses.

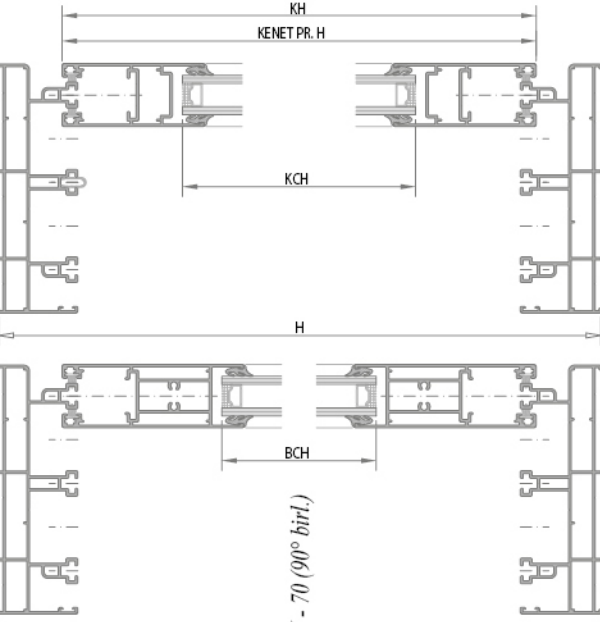

İmalat ve Kesim Planı

Cutting Dimensions

Sürme Eni	: L
sürme Yüksekliği	: H
KanatEni	: KL
Baza Kanat Eni	: BKL
Kanat Yüksekliği	: KH
Kanat Cam Eni	: KCL
Kanat Cam Yük	: KCH
Baza Kanat Cam Yük	: BCH
Kanat Çıta Eni	: K.Cıta L
Kanat Çıta Yük	: K.Cıta H
Kenel Profili H	: H - 66
Kanat Birt. Adap. H	: KH-29

H - 66 (45° birt.) H - 70 (90° birt.)

KLASİK SÜRME AÇILIM
CLASSICAL SLIDING OPENING

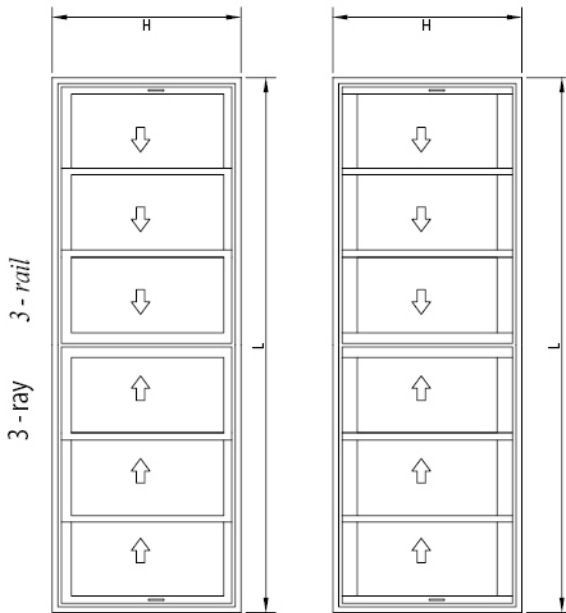

* Hesap yöntemi camların eşit olma esasına göre yapılmıştır.
The calculation method was made on the basis of the equality of the glasses.

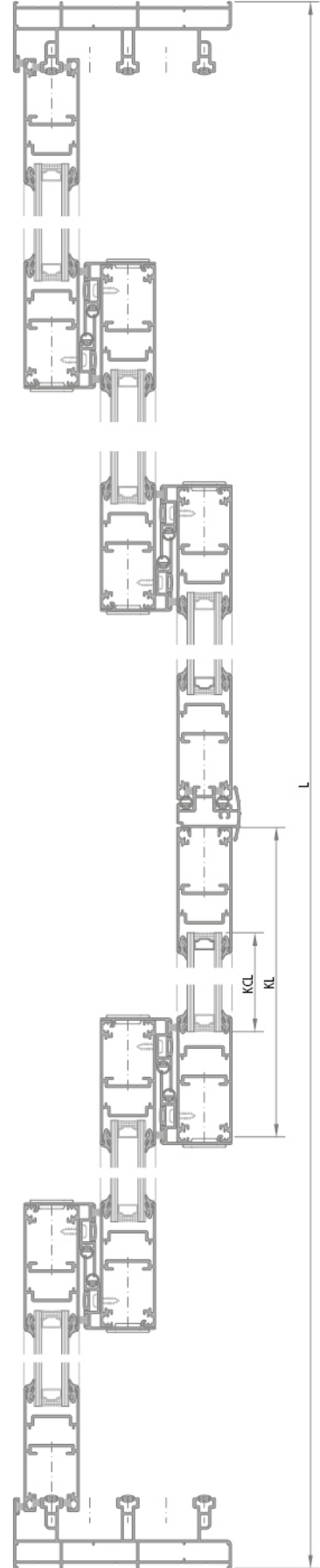

S32 KLASİK SÜRME SİSTEMİ / CLASSICAL SLIDE SYSTEM

KESİM - MONTAJ ÇİZİMLERİ / CUTTING ASSEMBLY DRAWINGS

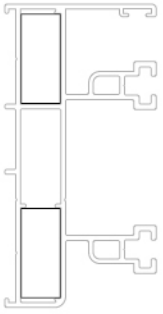
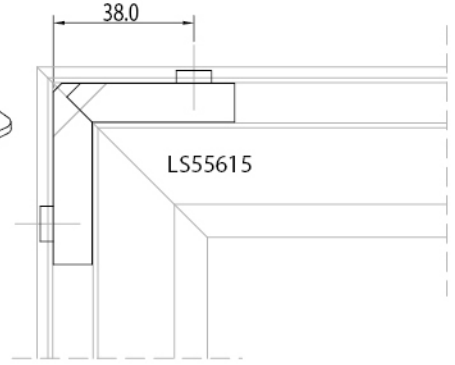
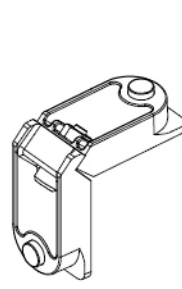
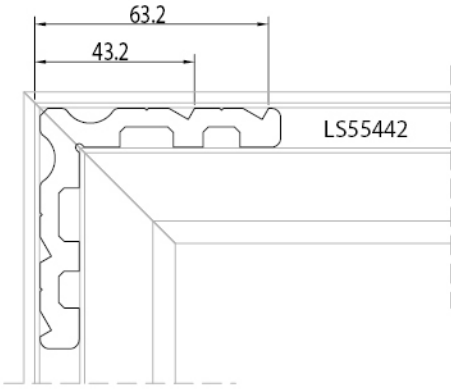

alternative

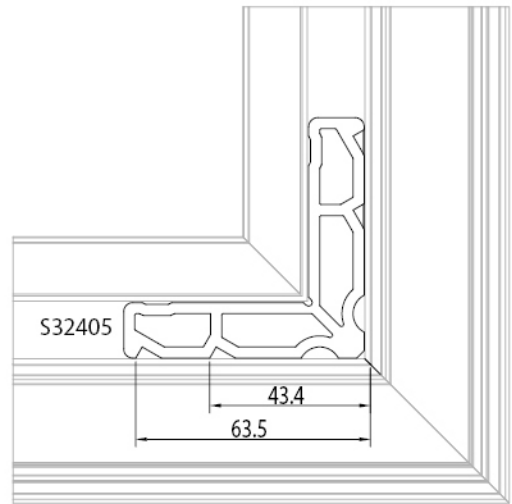
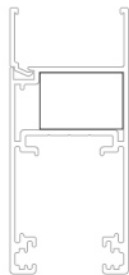
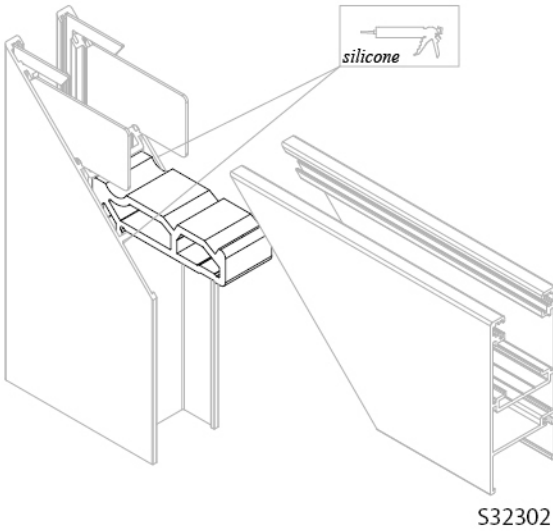
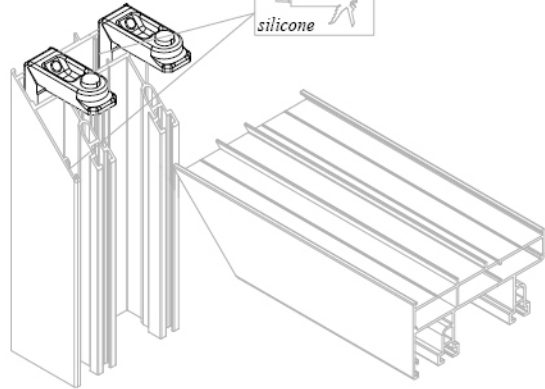
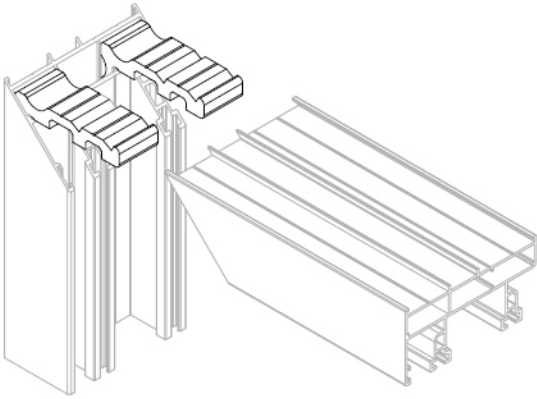
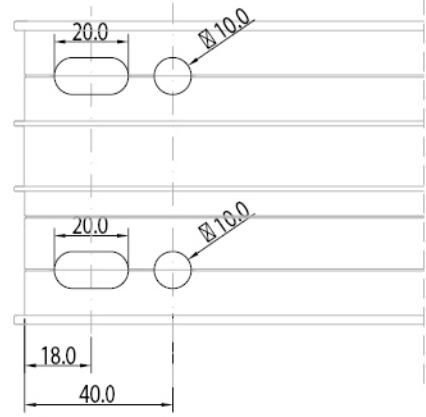
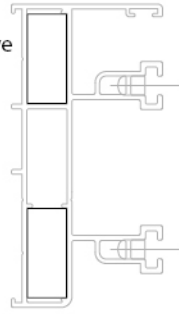

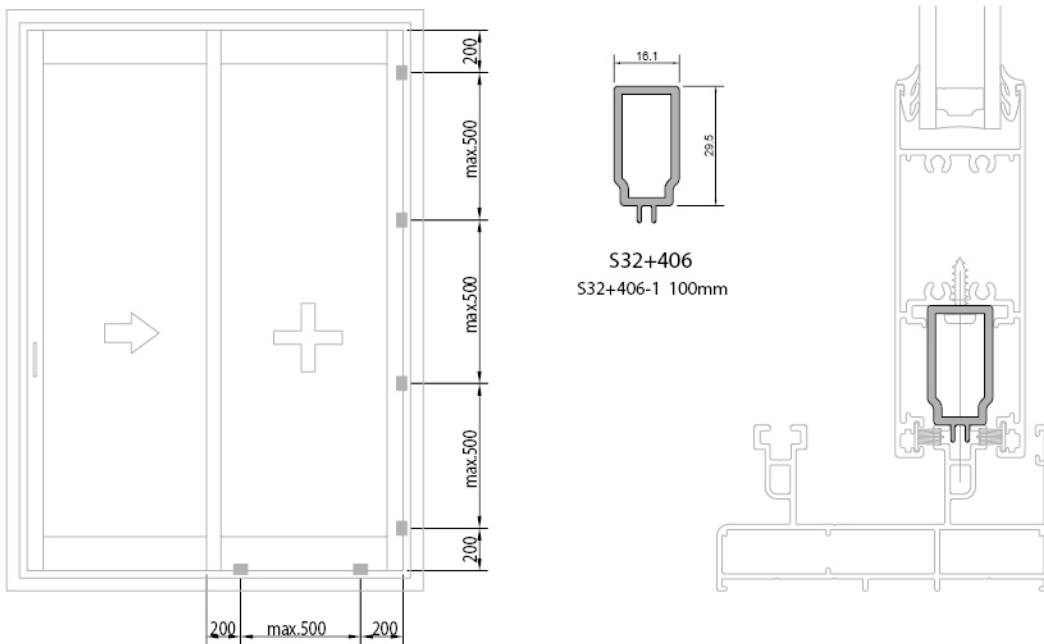
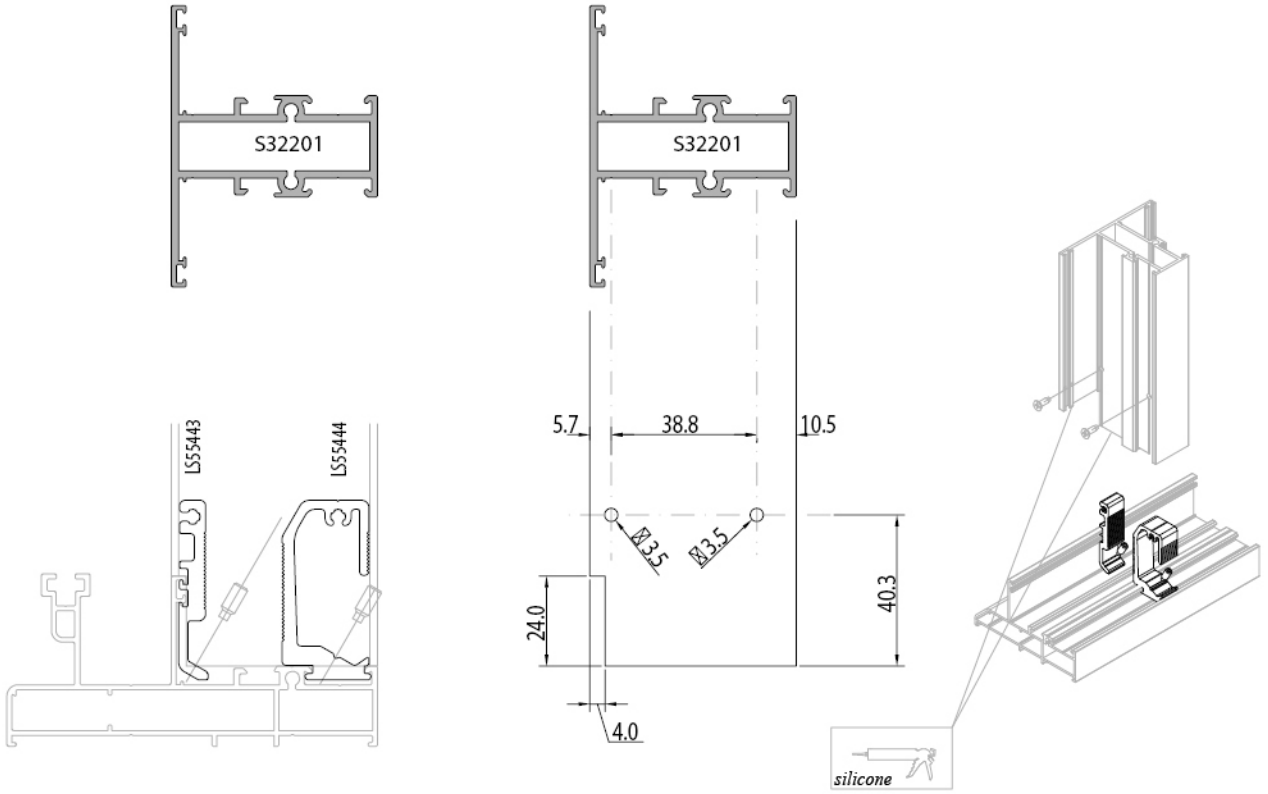

S32 KLASİK SÜRME SİSTEMİ / CLASSICAL SLIDE SYSTEM

KESİM - MONTAJ ÇİZİMLERİ / CUTTING ASSEMBLY DRAWINGS

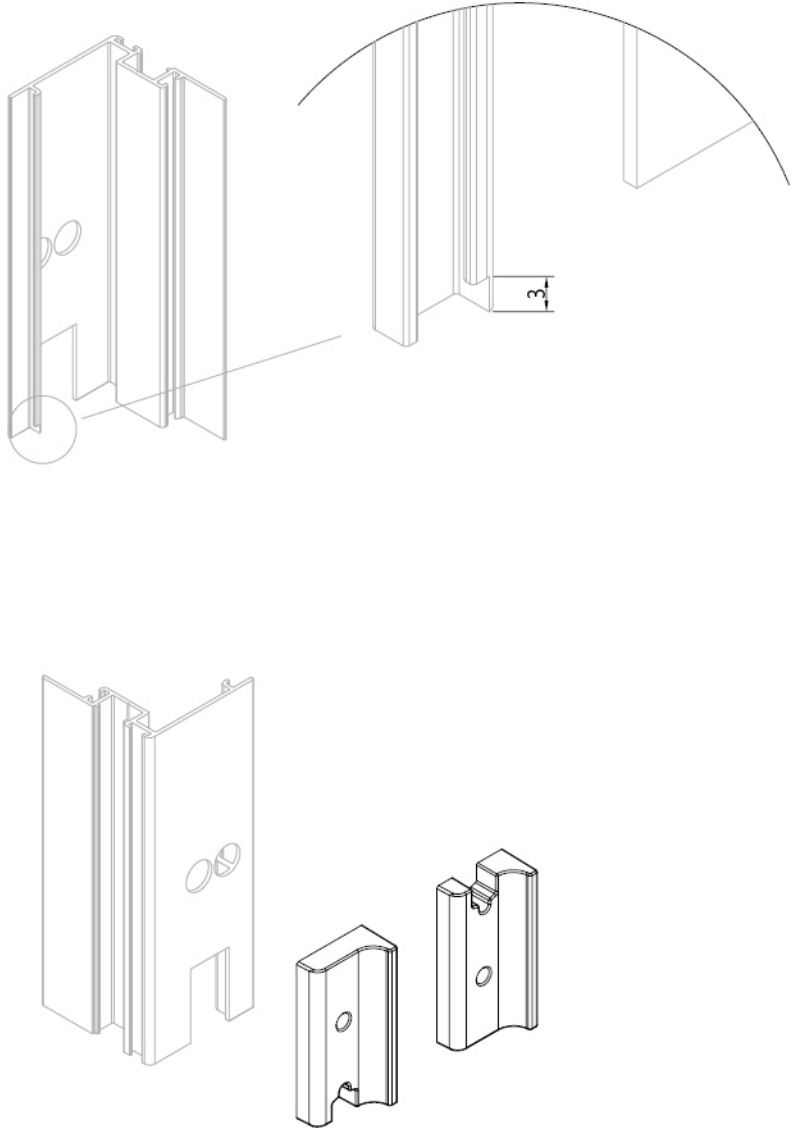
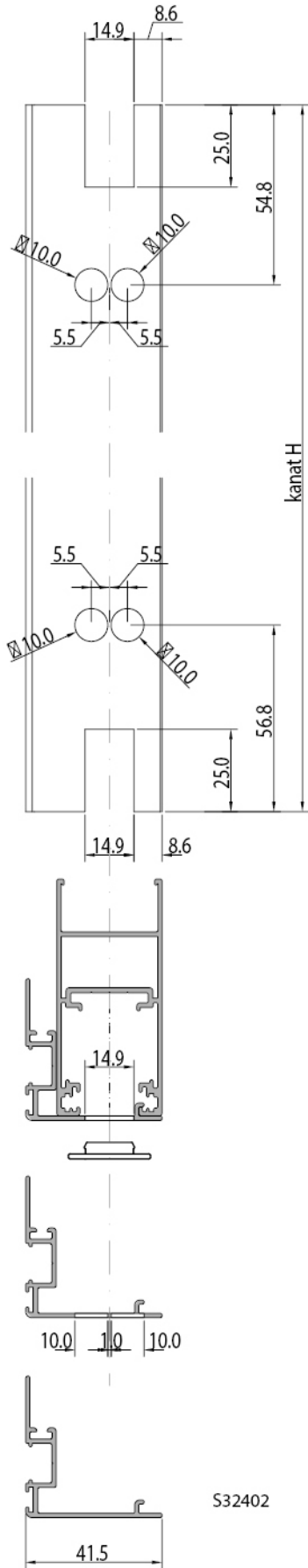

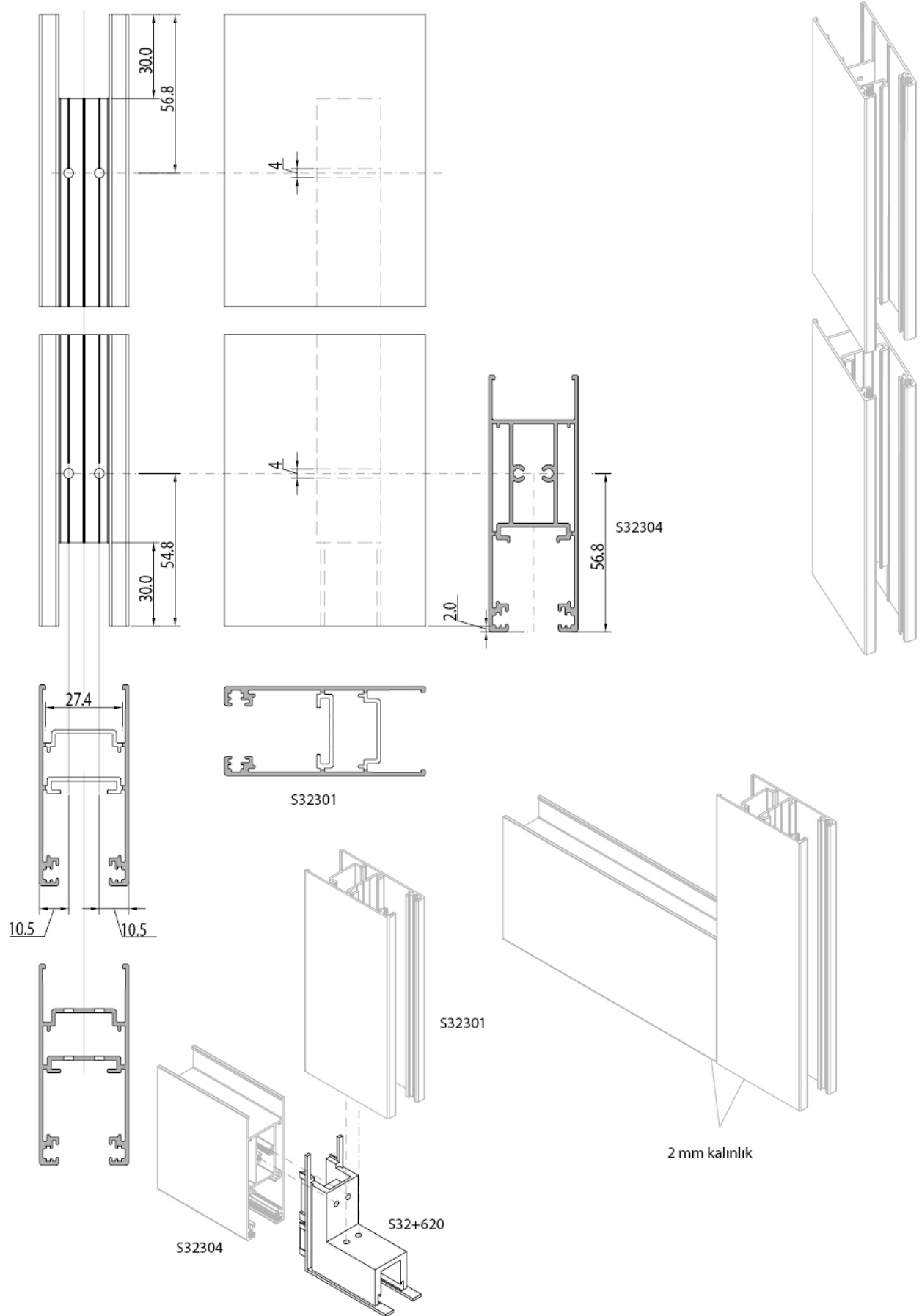

S32 KLASİK SÜRME SİSTEMİ / CLASSICAL SLIDE SYSTEM

KESİM - MONTAJ ÇİZİMLERİ / CUTTING ASSEMBLY DRAWINGS

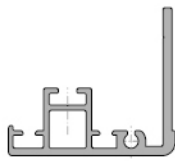
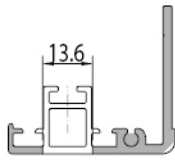
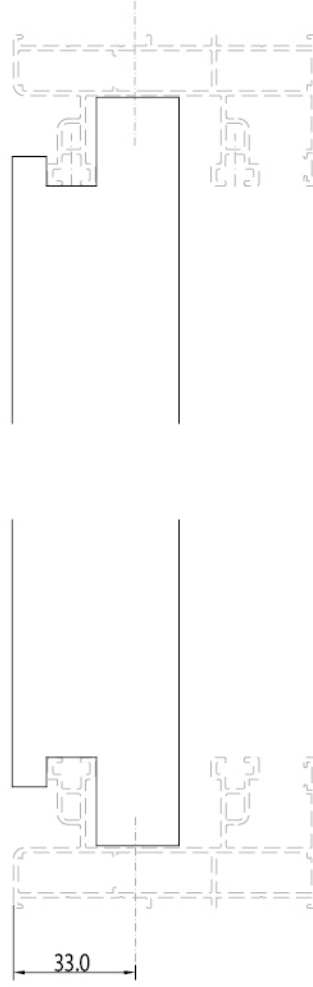
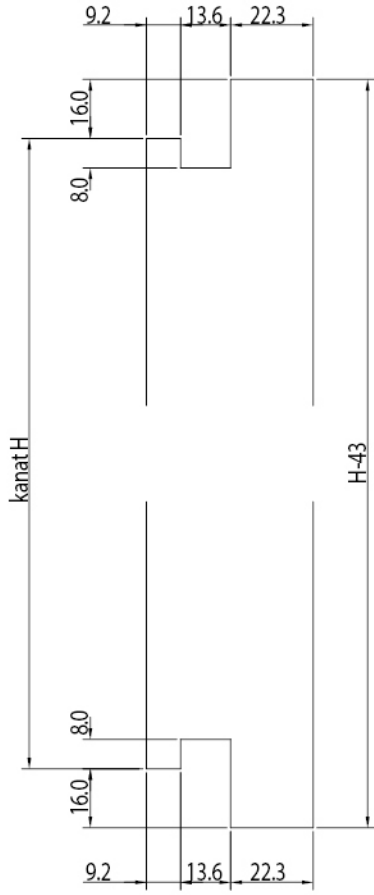

S32+403

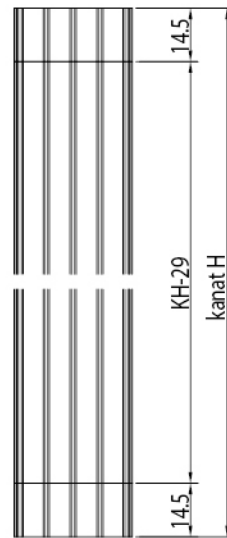
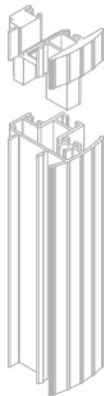

S32401

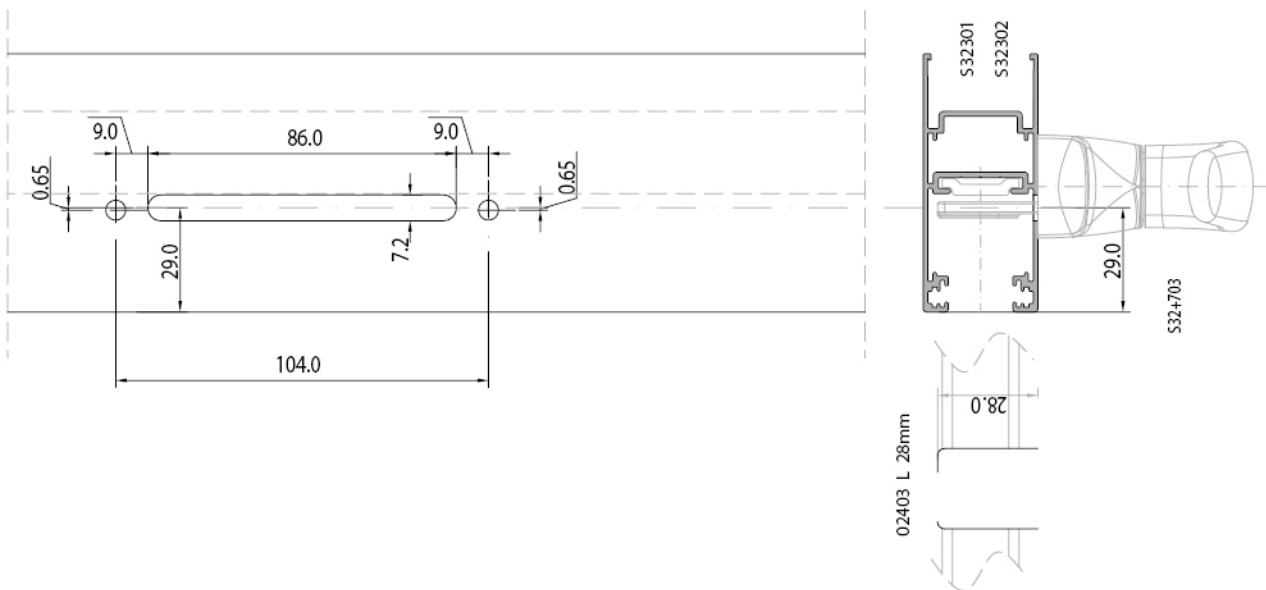
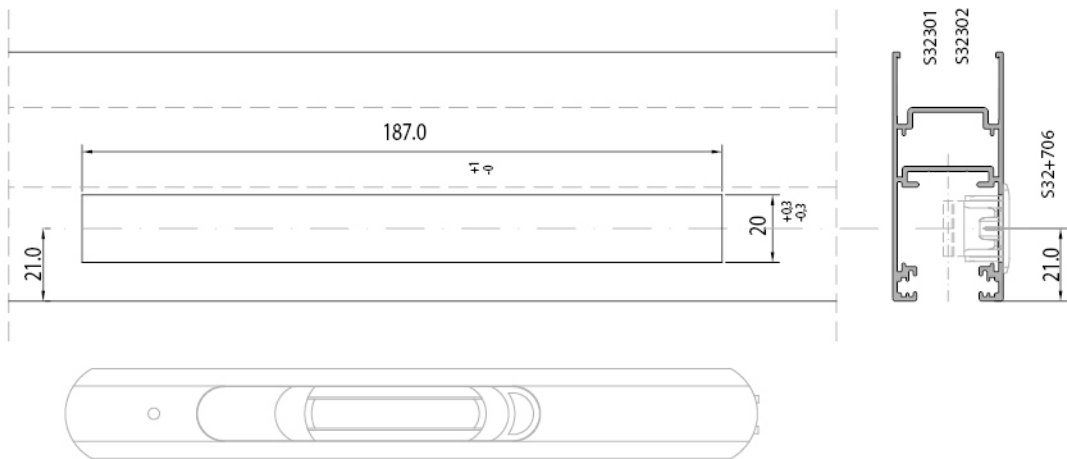
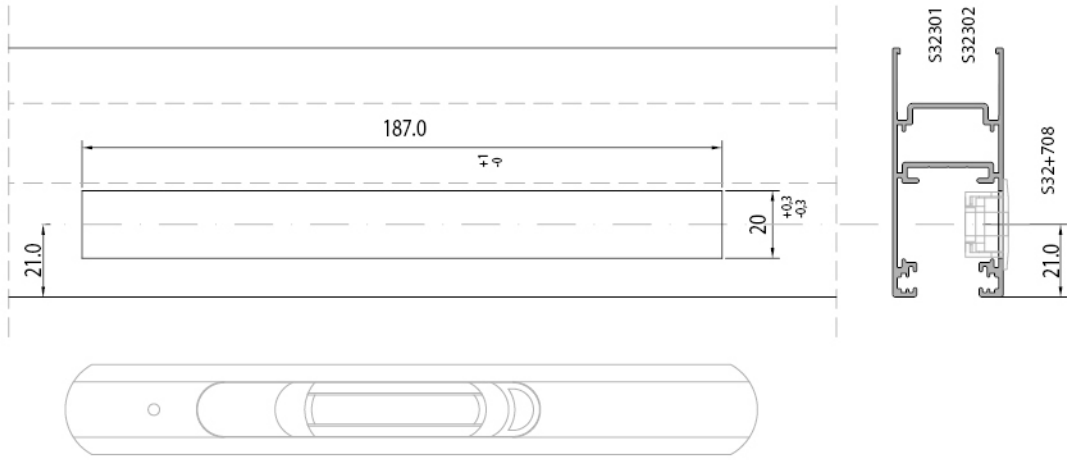

S32 KLASİK SÜRME SİSTEMİ / CLASSICAL SLIDE SYSTEM

KESİM - MONTAJ ÇİZİMLERİ / CUTTING ASSEMBLY DRAWINGS

