

W 5 5

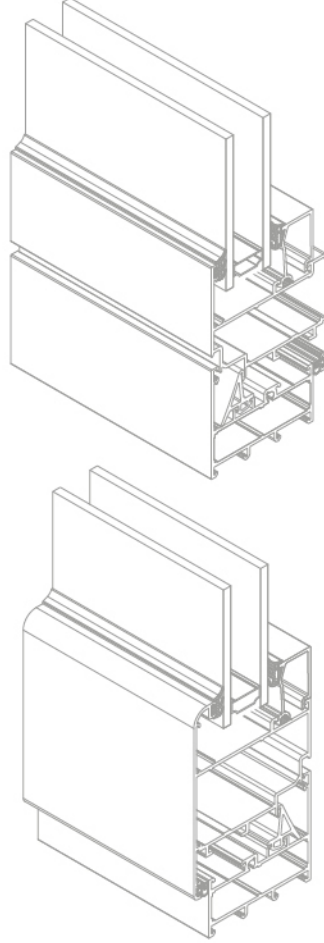

PENCERE VE KAPI SİSTEMİ WINDOW AND DOOR SYSTEM	W55	KASA	FRAME	100	W55 15.100 SİSTEM GRUP PR NO
		ORTA KAYIT	MULLION	200	
		KANAT	SASH	300	
		ADAPTÖR, BAGL. PR	ADAPTER	400	
		EPDM GRUP	EPDM GROUP	500	
		PVC GRUP	PVC GROUP	600	
		AÇILIM GRUP	OPENING GROUP	700	

PROFİL ET KALINLIĞI	PROFILE THICKNESS	1,5-2 mm
KASA YÜKSEKLİĞİ	FRAME HEIGHT	55 mm
KANAT YÜKSEKLİĞİ	SASH HEIGHT	63 mm
CAM KALINLIĞI	GLASS THICKNESS	4-38 mm

ALAŞIM ÖZELLİKLERİ
ALLOY PROPERTIES

EN AW 6060 (AlMgSi0,5 F22)
EN AW 6063 (AlMg0,7Si F22)

ÜRETİM VE MEKANİK STANDARTLAR
PRODUCTION AND MECHANICAL STANDARDS

EN 12020-2 EN 755-9 EN 755-2

**Köşe takoz profili**
Corner cleat profile

W55.450-5 50,6 mm

W55.450-6 39 mm

W55.452-5 50,6 mm

W55.452-6 39 mm

W55.451-5 50,6 mm

W55.451-6 39 mm

W55.454-4 39 mm

W55.454-5 43,5 mm

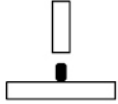
**Orta kayıt bağlantı**
Mullion connection

W55.15.456-1 12,5 mm

W55.15.456-2 22,5 mm

W55.15.456-3 32,6 mm

W55.15.456-4 25 mm

**Köşe onbaşı**
Corner cleat

LS55617 LS55618

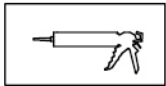
**Yatay sayfa**
Page horizontal**Silikon**
Silicone**Dikkat**
Attention

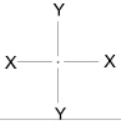

W55 PENCERE VE KAPI SİSTEMİ / WINDOW AND DOOR SYSTEM

ÜRÜN TEKNİK ÖZELLİKLERİ / PRODUCT TECHNICAL FEATURES

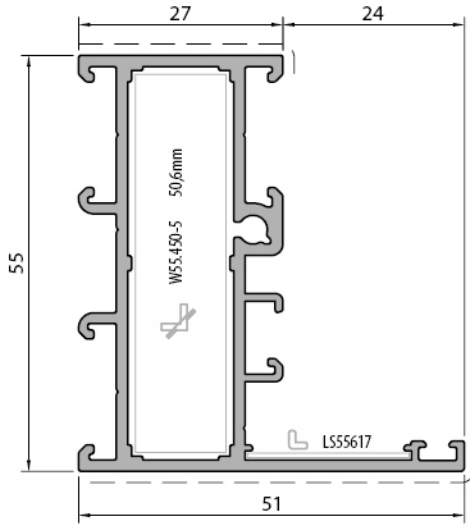

Kasa Profili / Frame profile	
W55.15.101	
Weight : 0,951 kg/m	
lx : 14,06 cm ⁴	Wx : 4,59 cm ³
ly : 4,41 cm ⁴	Wy : 1,30 cm ³

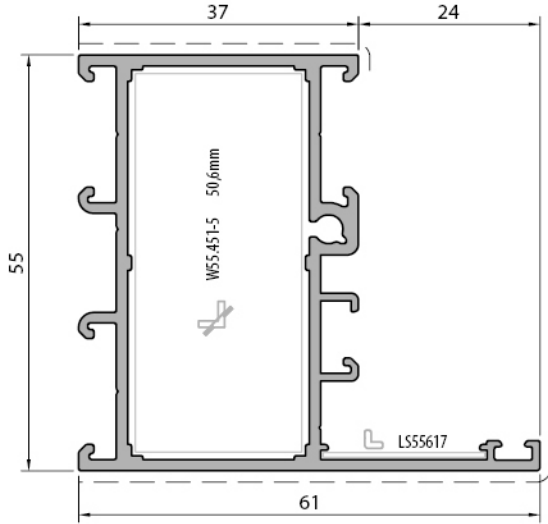

Kasa Profili / Frame profile	
W55.15.102	
Weight : 1,032 kg/m	
lx : 16,77 cm ⁴	Wx : 5,52 cm ³
ly : 8,28 cm ⁴	Wy : 2,16 cm ³

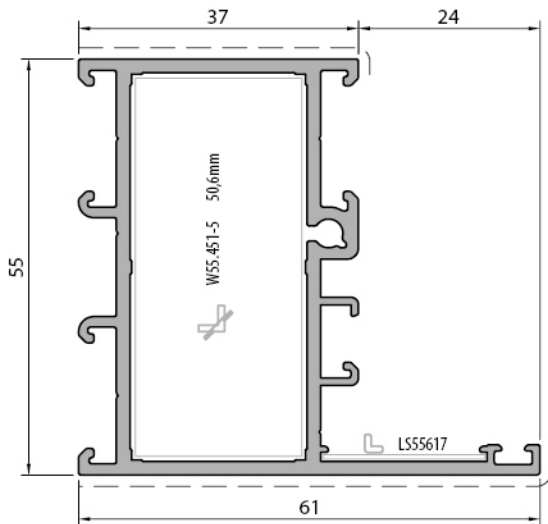

Kasa Profili / Frame profile	
W55.20.102	
Weight : 1,159 kg/m	
lx : 18,62 cm ⁴	Wx : 4,96 cm ³
ly : 8,96 cm ⁴	Wy : 2,94 cm ³

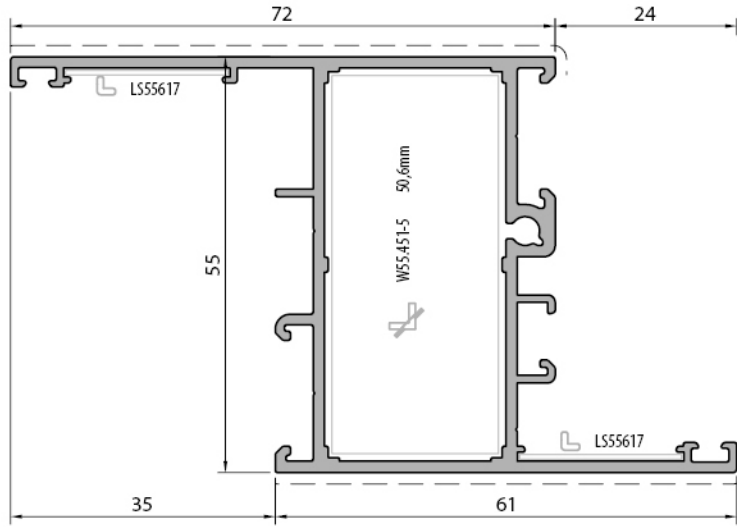

Kasa Profili / Frame profile	
W55.15.103	
Weight : 1,179 kg/m	
lx : 28,75 cm ⁴	Wx : 10,08 cm ³
ly : 10,22 cm ⁴	Wy : 1,95 cm ³

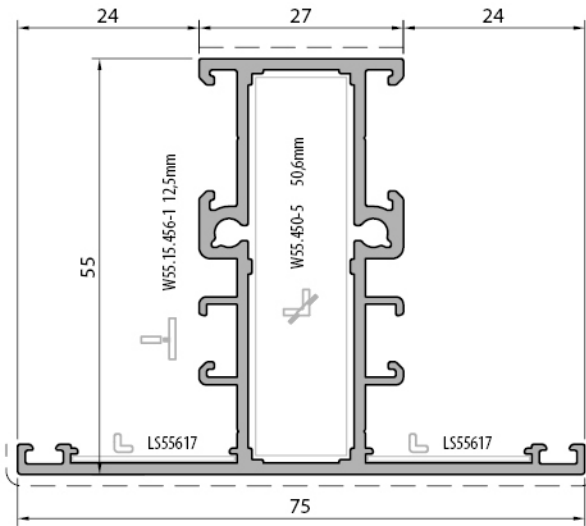

Orta Kayıt Profili / Mullion profile	
W55.15.201	
Weight : 1,108 kg/m	
lx : 15,49 cm ⁴	Wx : 4,72 cm ³
ly : 9,11 cm ⁴	Wy : 2,42 cm ³

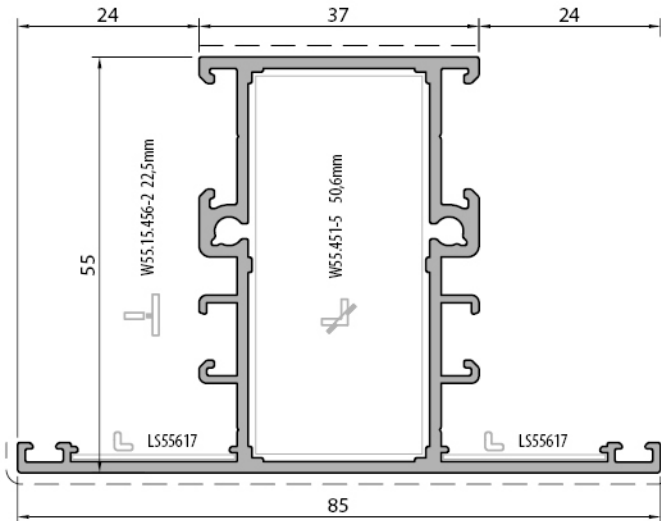

Orta Kayıt Profili / Mullion profile	
W55.15.202	
Weight : 1,189 kg/m	
lx : 17,72 cm ⁴	Wx : 5,46 cm ³
ly : 15,20 cm ⁴	Wy : 3,57 cm ³

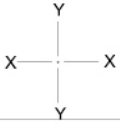

W55 PENCERE VE KAPI SİSTEM / WINDOW AND DOOR SYSTEM

ÜRÜN TEKNİK ÖZELLİKLERİ / PRODUCT TECHNICAL FEATURES

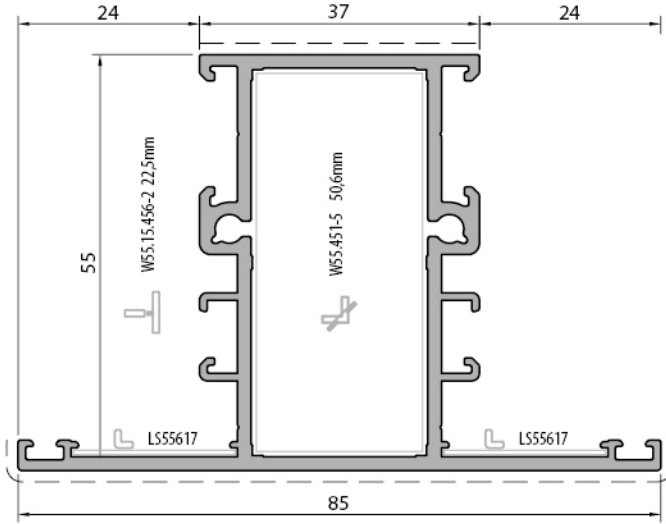

Orta Kayıt Profili / Mullion profile	
W55.20.202	
Weight : 1,333 kg/m	
$I_x : 19,73 \text{ cm}^4$	$W_x : 74,64 \text{ cm}^3$
$I_y : 16,45 \text{ cm}^4$	$W_y : 5,04 \text{ cm}^3$

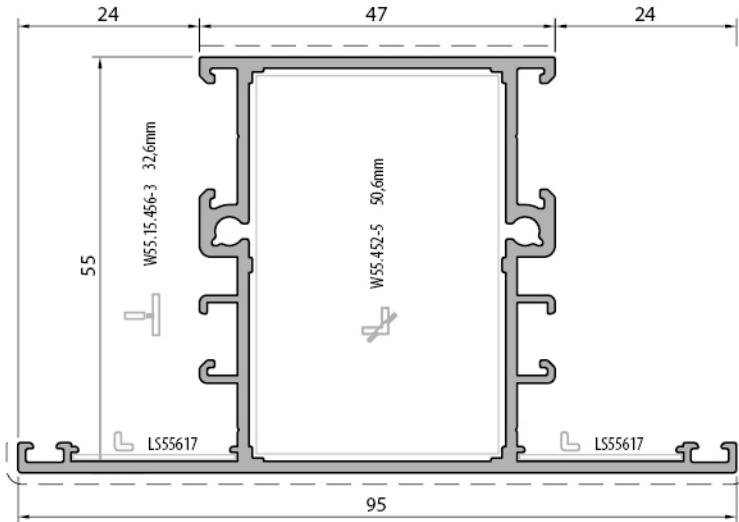

Orta Kayıt Profili / Mullion profile	
W55.15.203	
Weight : 1,270 kg/m	
$I_x : 19,93 \text{ cm}^4$	$W_x : 6,20 \text{ cm}^3$
$I_y : 23,48 \text{ cm}^4$	$W_y : 4,94 \text{ cm}^3$

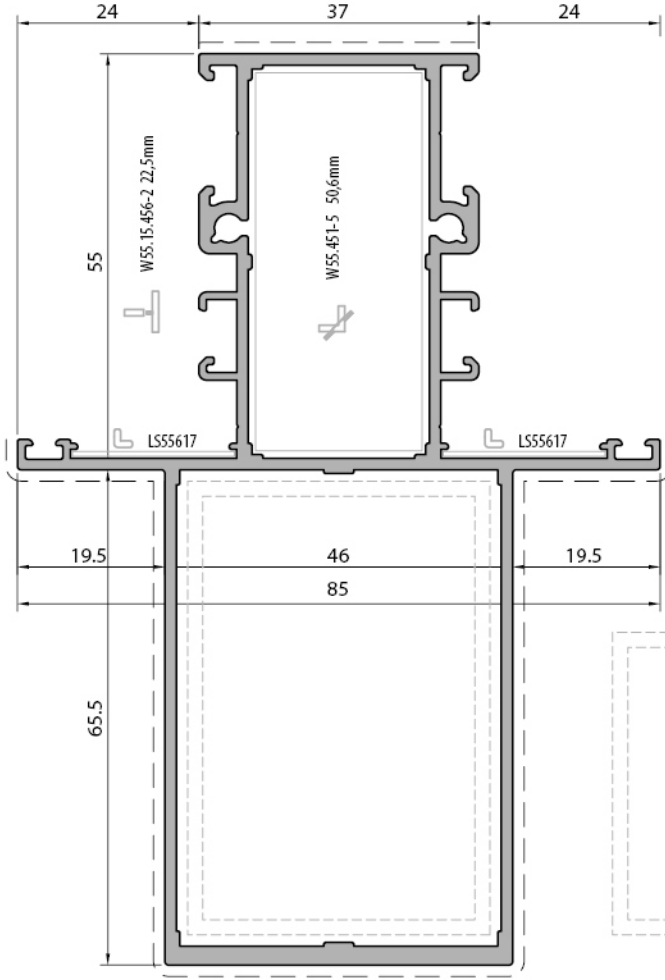
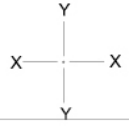

Orta Kayıt Profili / Mullion profile	
W55.15.204	
Weight : 2,031 kg/m	
$I_x : 112,37 \text{ cm}^4$	$W_x : 18,52 \text{ cm}^3$
$I_y : 26,76 \text{ cm}^4$	$W_y : 6,29 \text{ cm}^3$

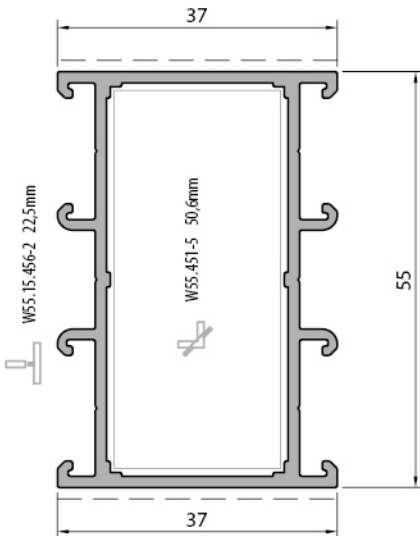

Orta Kayıt Profili / Mullion profile	
W55.15.205	
Weight : 0,888 kg/m	
$I_x : 12,87 \text{ cm}^4$	$W_x : 4,68 \text{ cm}^3$
$I_y : 5,25 \text{ cm}^4$	$W_y : 2,83 \text{ cm}^3$

Profil değerleri teoriktir. Ağırlık olarak teslimde yapılan tartım geçerlidir. Profil imatları TS EN 12020-02 ve TS EN 755-9 toleransı, Moment değerleri EN 14024'e göre hesaplanmıştır.

Profile values are theoretical pre-shipment weight will be valid. The tolerances of Profile manufacturing are calculated according to EN 12020-2 and TS EN 755-9; moment values are calculated according to EN 14024.

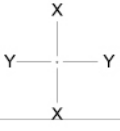

W55 PENCERE VE KAPI SİSTEM / WINDOW AND DOOR SYSTEM

ÜRÜN TEKNİK ÖZELLİKLERİ / PRODUCT TECHNICAL FEATURES

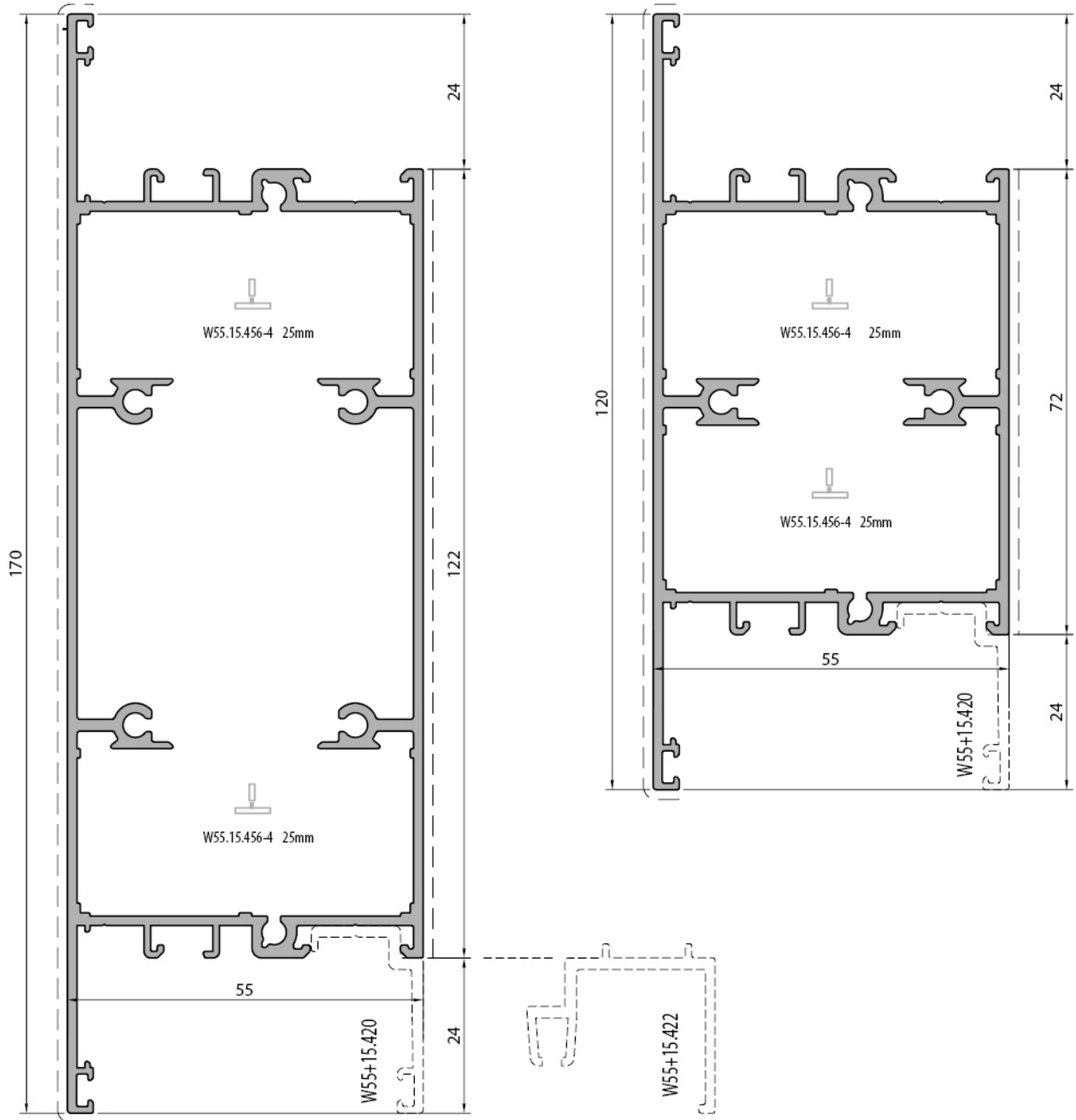

Orta Kayıt Profili + Etek Profili Mullion + bottom sash profile	
W55.15.215	
Weight : 2,298 kg/m	
lx : 42,22 cm ⁴	Wx : 13,84 cm ³
ly : 181,31 cm ⁴	Wy : 21,33 cm ³

Orta Kayıt Profili + Etek Profili Mullion + bottom sash profile	
W55.15.216	
Weight : 1,725 kg/m	
lx : 28,89 cm ⁴	Wx : 9,34 cm ³
ly : 54,88 cm ⁴	Wy : 9,14 cm ³

Profil değerleri teoriktir. Ağırlık olarak teslimde yapılan tartım geçerlidir. Profil imalatları TS EN 12020-02 ve TS EN 755-9 toleransı, Moment değerleri EN 14024'e göre hesaplanmıştır.
Profile values are theoretical pre-shipment weight will be valid. The tolerances of Profile manufacturing are calculated according to EN 12020-2 and TS EN 755-9; moment values are calculated according to EN 14024.

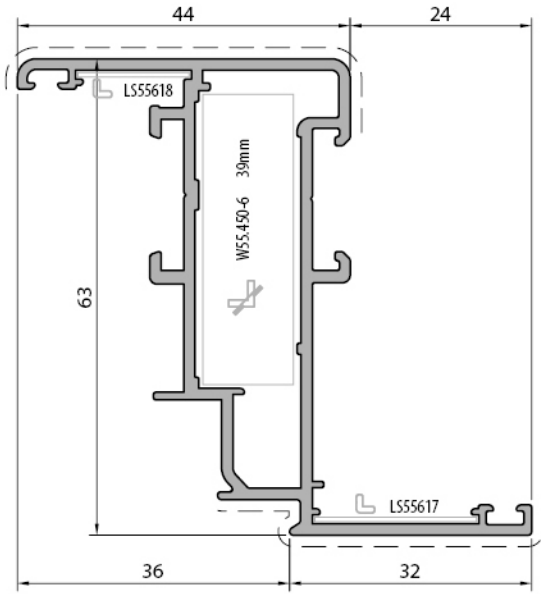
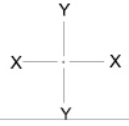

Kanat Profili (içe açılır) Sash profile (inward opening)	
W55.15.301	
Weight : 1,024 kg/m	
lx : 22,08 cm ⁴	Wx : 6,59 cm ³
ly : 4,22 cm ⁴	Wy : 1,17 cm ³

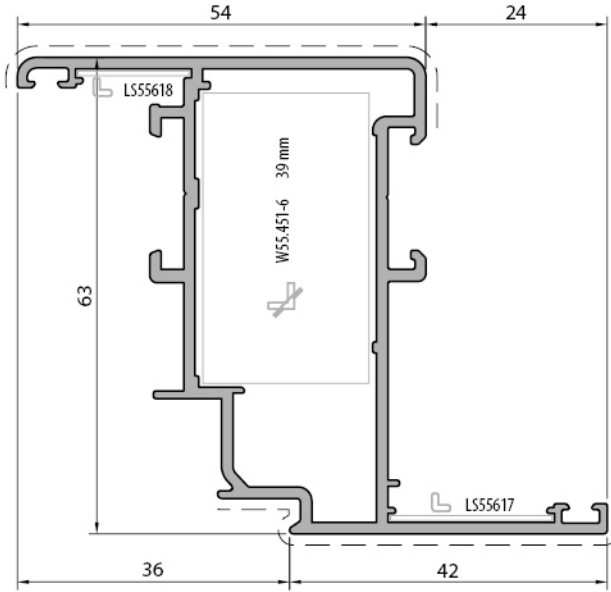

Kanat Profili (içe açılır) Sash profile (inward opening)	
W55.15.302	
Weight : 1,125 kg/m	
lx : 26,99 cm ⁴	Wx : 8,21 cm ³
ly : 7,87 cm ⁴	Wy : 1,93 cm ³

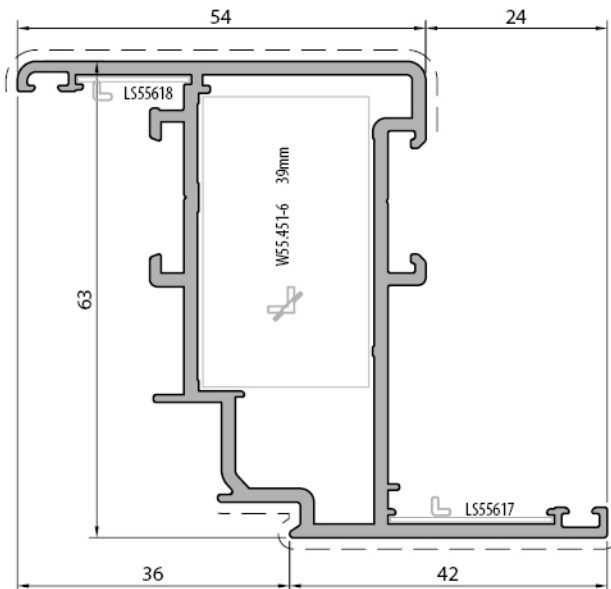

Kanat Profili (içe açılır) Sash profile (inward opening)	
W55.20.302	
Weight : 1,285 kg/m	
lx : 30,21 cm ⁴	Wx : 7,45 cm ³
ly : 8,78cm ⁴	Wy : 2,68 cm ³

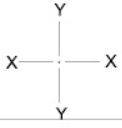

W55 PENCERE VE KAPI SİSTEM / WINDOW AND DOOR SYSTEM

ÜRÜN TEKNİK ÖZELLİKLERİ / PRODUCT TECHNICAL FEATURES

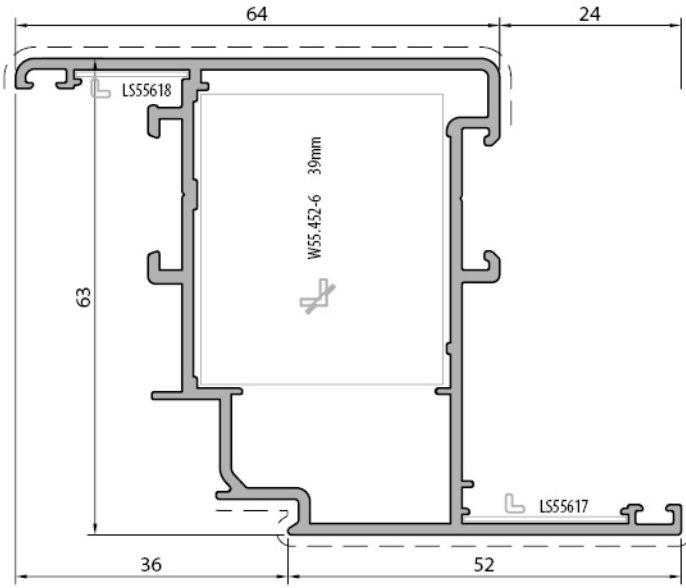

Kanat Profili (içe açılır) Sash profile (inward opening)	
W55.15.303	
Weight : 1,206 kg/m	
lx : 32,33 cm ⁴	Wx : 9,87 cm ³
ly : 12,61 cm ⁴	Wy : 2,76 cm ³

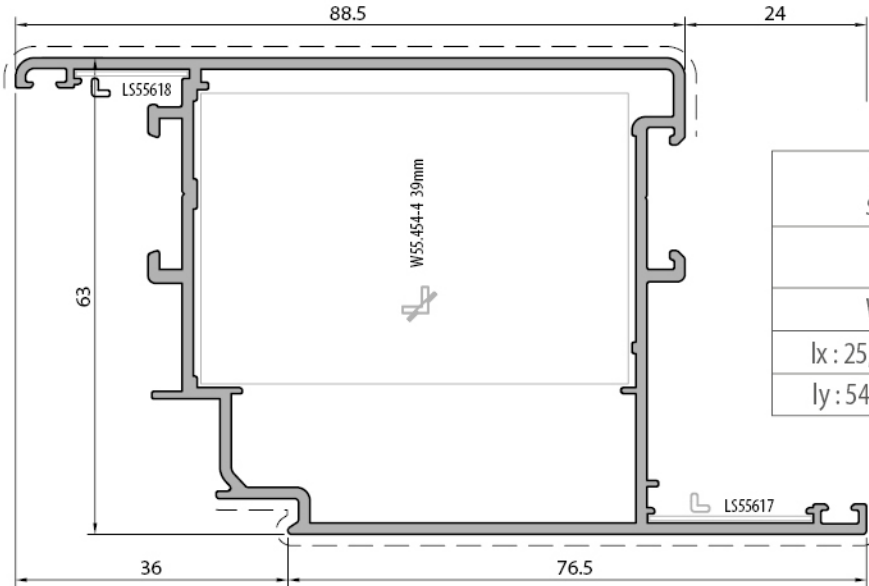

Kanat Profili (içe açılır) Sash profile (inward opening)	
W55.15.304	
Weight : 1,404 kg/m	
lx : 25,04 cm ⁴	Wx : 7,68 cm ³
ly : 54,37 cm ⁴	Wy : 9,37 cm ³

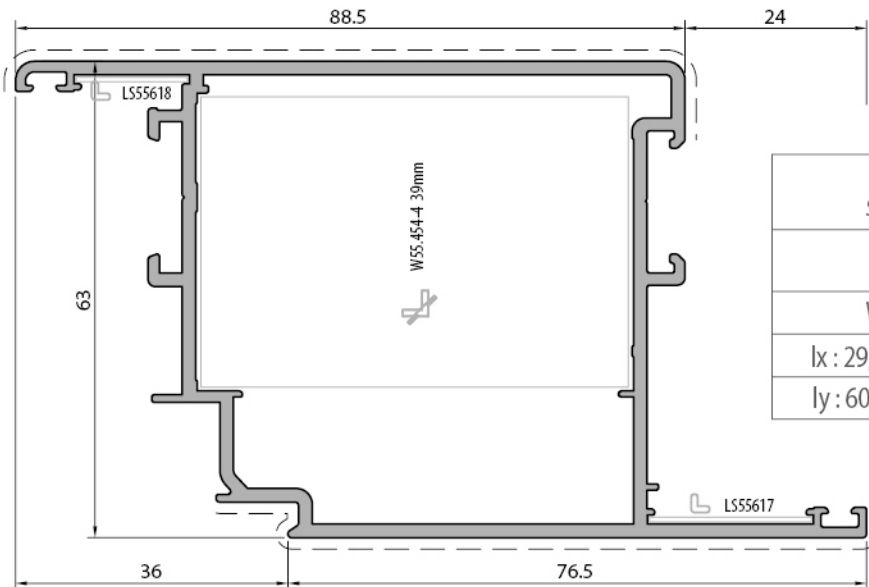

Kanat Profili (içe açılır) Sash profile (inward opening)	
W55.20.304	
Weight : 1,622 kg/m	
lx : 29,00 cm ⁴	Wx : 5,02 cm ³
ly : 60,62 cm ⁴	Wy : 18,64 cm ³

Profil değerleri teoriktir. Ağırlık olarak teslimde yapılan tartım geçerlidir. Profil imalatları TS EN 12020-02 ve TS EN 755-9 toleransı, Moment değerleri EN 14024'e göre hesaplanmıştır.
Profile values are theoretical pre-shipment weight will be valid. The tolerances of Profile manufacturing are calculated according to EN 12020-2 and TS EN 755-9; moment values are calculated according to EN 14024.

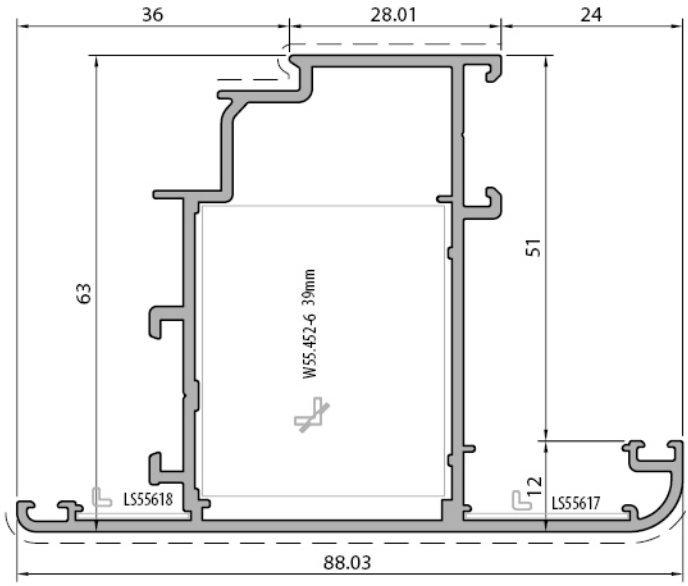
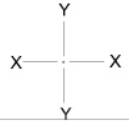

Kanat Profili (dışa açılır) Sash profile (outward opening)	
W55.15.310	
Weight : 1,239 kg/m	
lx : 24,23 cm ⁴	Wx : 6,26 cm ³
ly : 22,29 cm ⁴	Wy : 5,03 cm ³

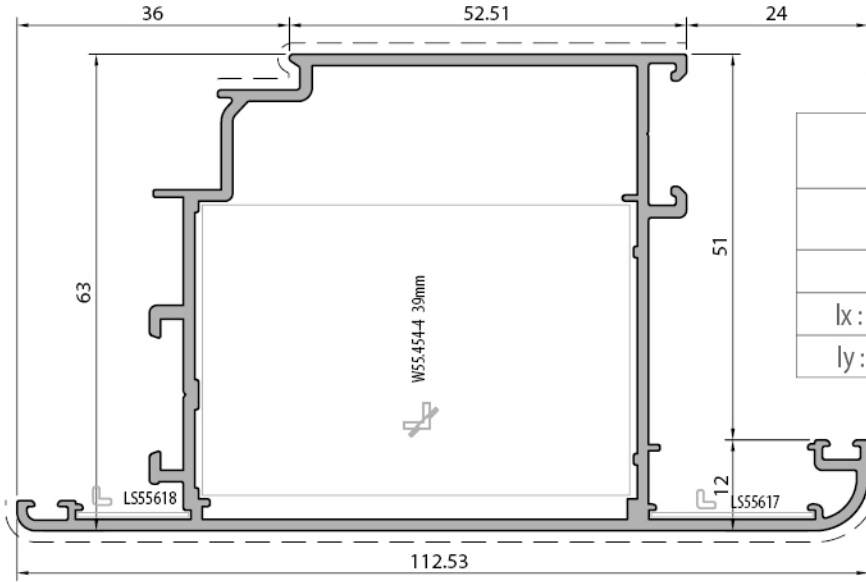

Kanat Profili (dışa açılır) Sash profile (outward opening)	
W55.15.311	
Weight : 1,442 kg/m	
lx : 31,49 cm ⁴	Wx : 8,35 cm ³
ly : 51,60 cm ⁴	Wy : 9,14 cm ³

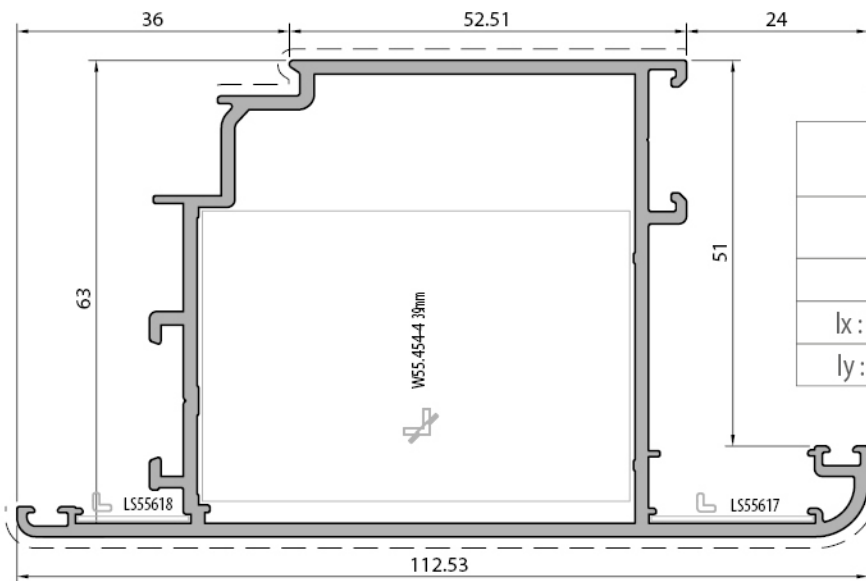

Kanat Profili (dışa açılır) Sash profile (outward opening)	
W55.20.311	
Weight : 1,652 kg/m	
lx : 35,98 cm ⁴	Wx : 9,59 cm ³
ly : 57,16 cm ⁴	Wy : 10,14 cm ³

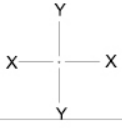

W55 PENCERE VE KAPI SİSTEM / WINDOW AND DOOR SYSTEM

ÜRÜN TEKNİK ÖZELLİKLERİ / PRODUCT TECHNICAL FEATURES

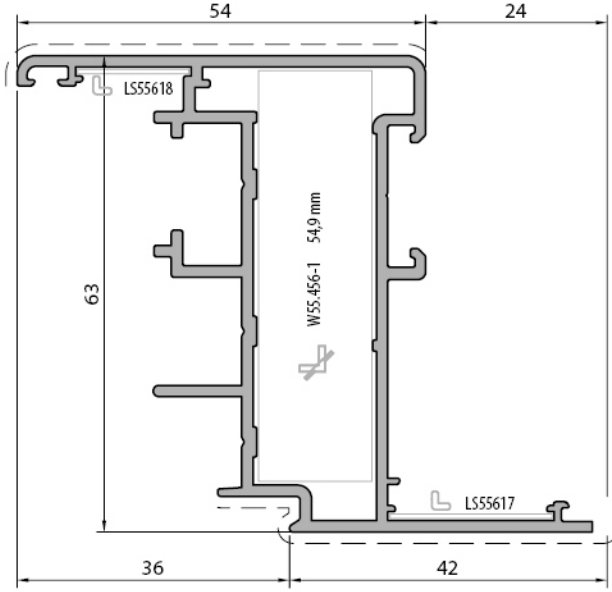

Kanat Profili (içe açılır) Sash profile (inward opening)	
W55.15.457	
Weight : 1,207 kg/m	
lx : 27,26 cm ⁴	Wx : 6,76 cm ³
ly : 7,34 cm ⁴	Wy : 2,20 cm ³

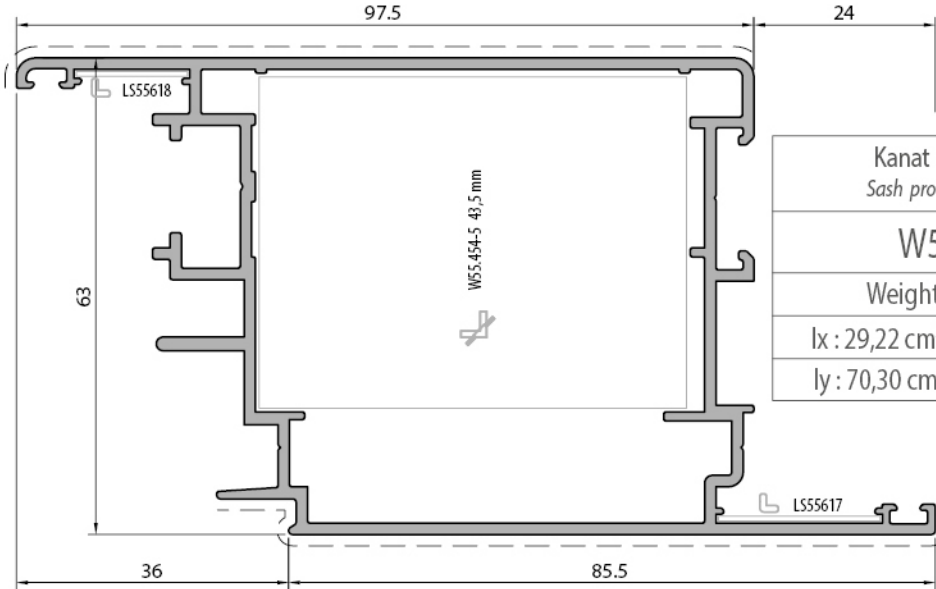

Kanat Profili (içe açılır) Sash profile (inward opening)	
W55.15.312	
Weight : 1,650 kg/m	
lx : 29,22 cm ⁴	Wx : 4,69 cm ³
ly : 70,30 cm ⁴	Wy : 21,70 cm ³

Profil değerleri teoriktir. Ağırlık olarak teslimde yapılan tartım geçerlidir. Profil imalatları TS EN 12020-02 ve TS EN 755-9 toleransı, Moment değerleri EN 14024'e göre hesaplanmıştır.
Profile values are theoretical pre-shipment weight will be valid. The tolerances of Profile manufacturing are calculated according to EN 12020-2 and TS EN 755-9; moment values are calculated according to EN 14024.

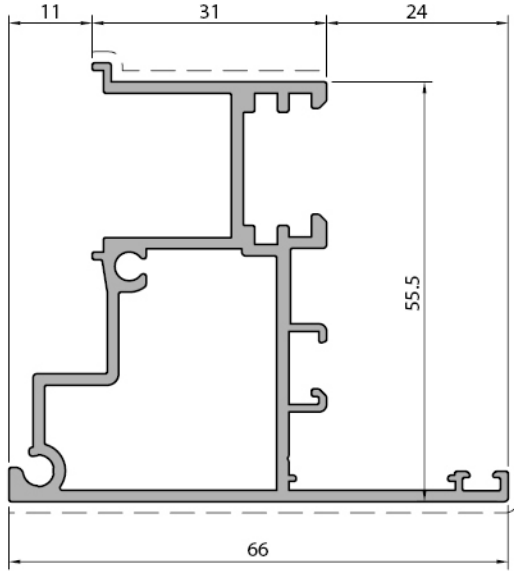
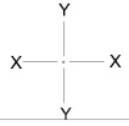

Çift Kanat Adaptör Profili
Double sash adapter profile

W55.15.401

Weight : 1,088 kg/m

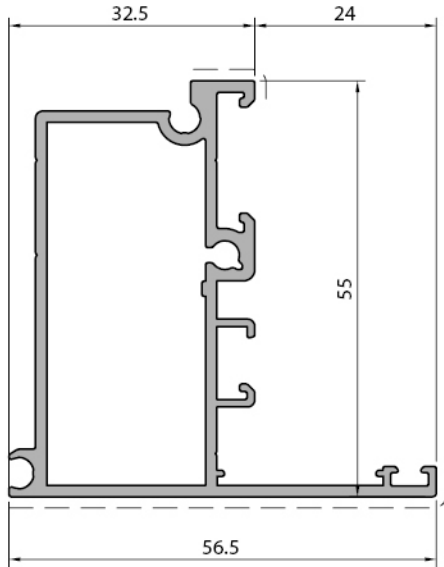
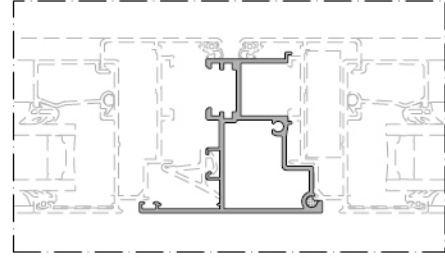

Kasa Adaptör Profili
Frame adapter profile

W55.15.402

Weight : 0,925 kg/m

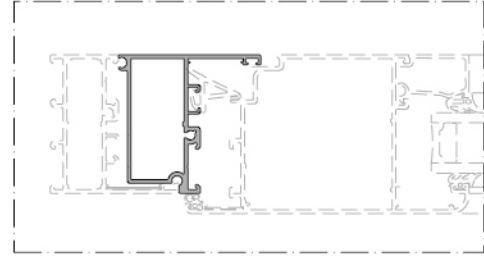

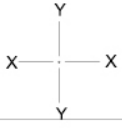

W55 PENCERE VE KAPI SİSTEM / WINDOW AND DOOR SYSTEM

ÜRÜN TEKNİK ÖZELLİKLERİ / PRODUCT TECHNICAL FEATURES

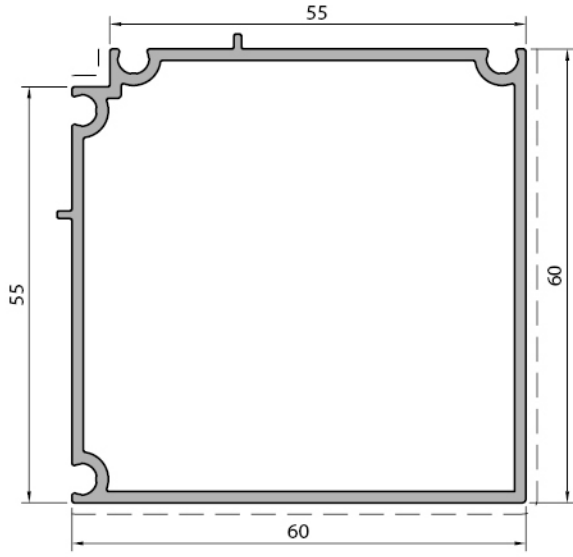

Köşe Profili / Corner profile 90°

W55.15.411

Weight : 0,988 kg/m

Ix : 20,66 cm⁴

Wx : 6,68 cm³

Iy : 20,32 cm⁴

Wy : 6,79 cm³

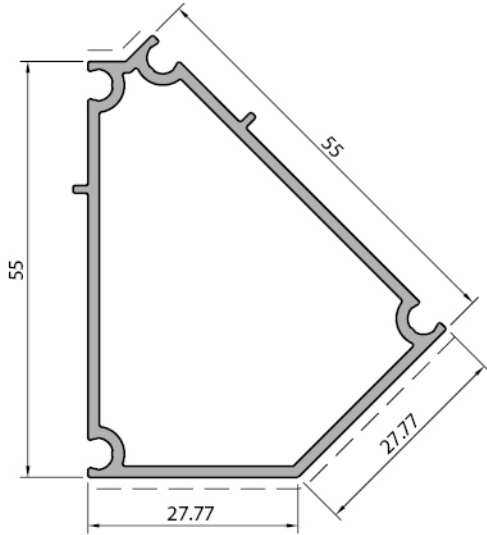
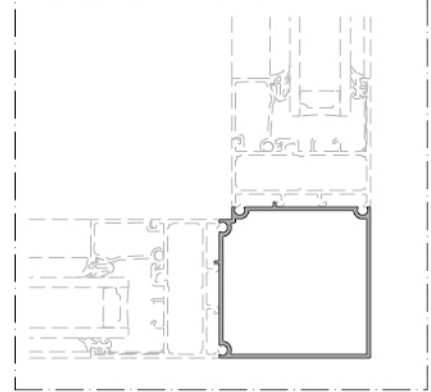

Köşe Profili / Corner profile 135°

W55.15.412

Weight : 0,729 kg/m

Ix : 10,15 cm⁴

Wx : 3,05 cm³

Iy : 5,70 cm⁴

Wy : 2,23 cm³

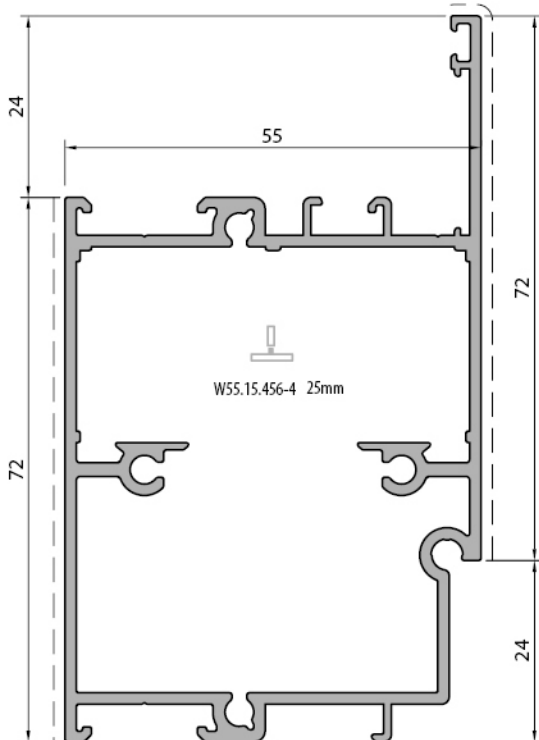

Kapı Altı Adaptör Profili
Bottom door adapter profile

W55.15.417

Weight : 1,542 kg/m

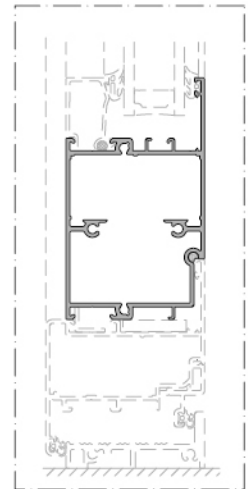

Profil değerleri teoriktir. Ağırlık olarak teslimde yapılan tartım geçerlidir. Profil imalatları TS EN 12020-02 ve TS EN 755-9 toleransı, Moment değerleri EN 14024'e göre hesaplanmıştır.
Profile values are theoretical pre-shipment weight will be valid. The tolerances of Profile manufacturing are calculated according to EN 12020-2 and TS EN 755-9; moment values are calculated according to EN 14024.

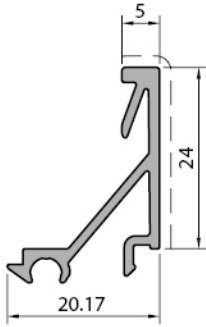
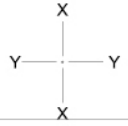

Cam Çıtası Profili
Glazing bead profile

LS55430

Weight : 0,258 kg/m

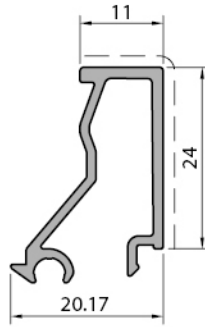

Cam Çıtası Profili
Glazing bead profile

LS55431

Weight : 0,282 kg/m

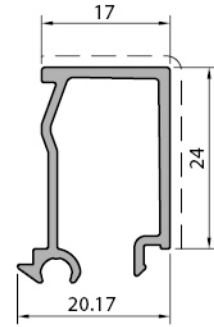

Cam Çıtası Profili
Glazing bead profile

LS55432

Weight : 0,294 kg/m

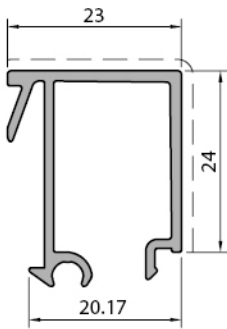

Cam Çıtası Profili
Glazing bead profile

LS55433

Weight : 0,341 kg/m

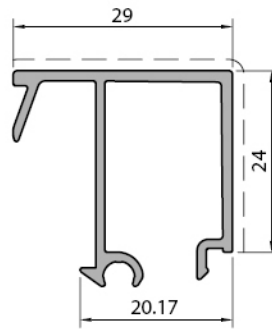

Cam Çıtası Profili
Glazing bead profile

LS55434

Weight : 0,363 kg/m

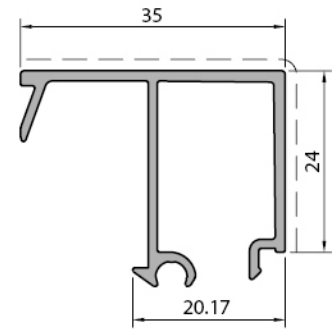

Cam Çıtası Profili
Glazing bead profile

LS55435

Weight : 0,385 kg/m

W55 PENCERE VE KAPI SİSTEM / WINDOW AND DOOR SYSTEM

ÜRÜN TEKNİK ÖZELLİKLERİ / PRODUCT TECHNICAL FEATURES

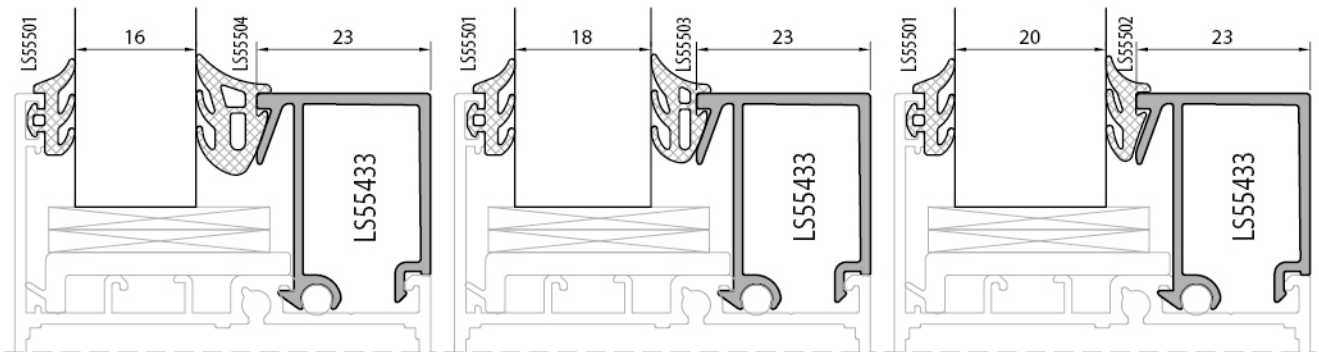
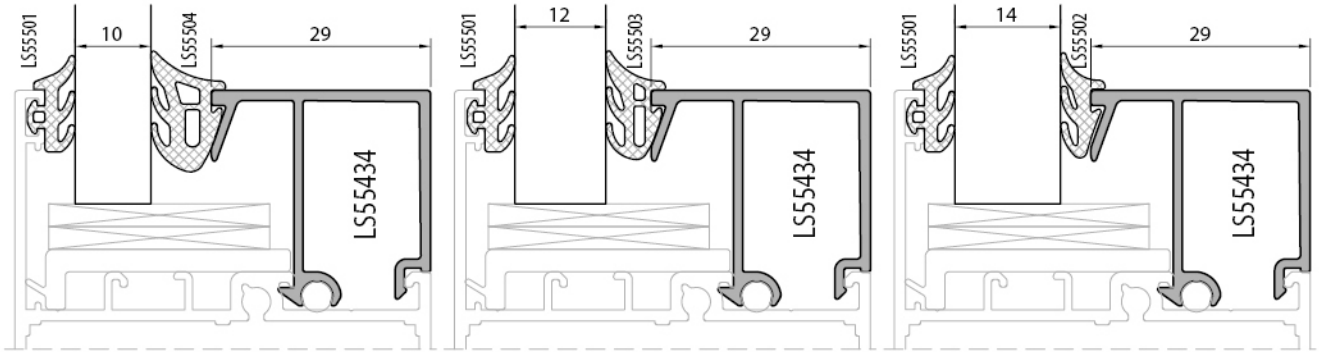
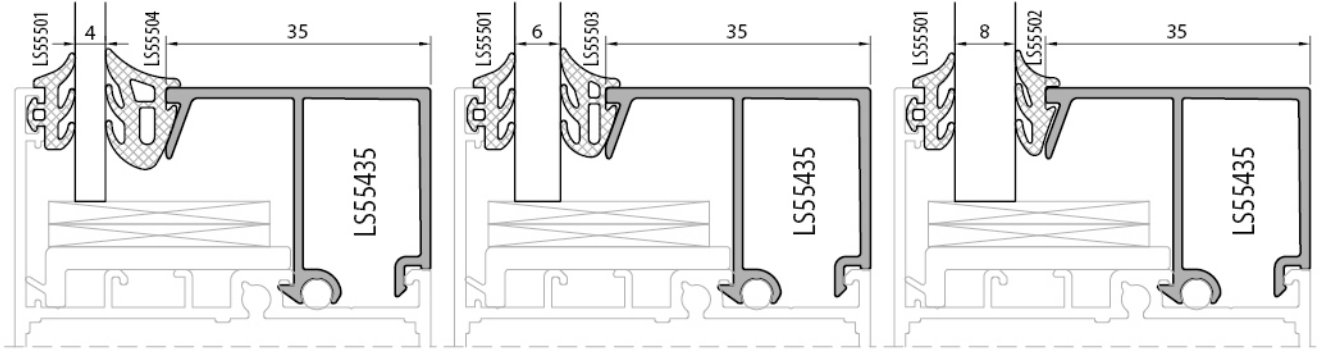

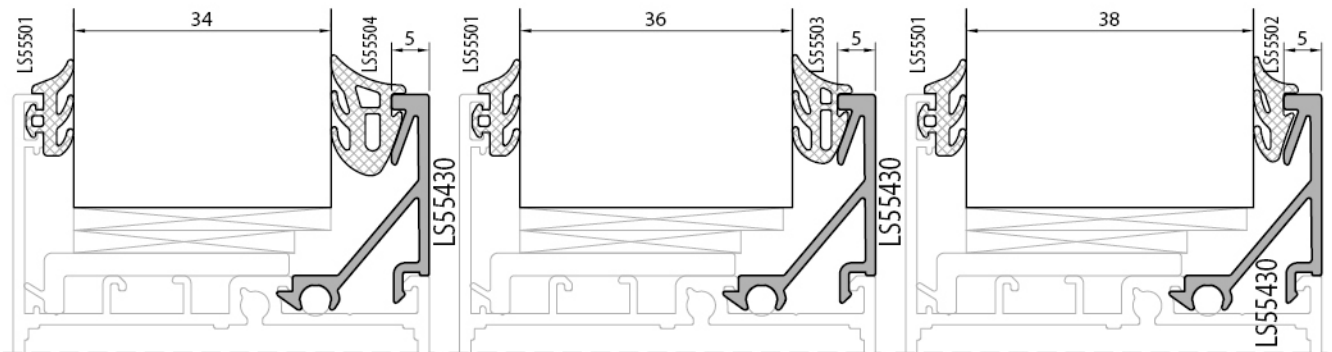
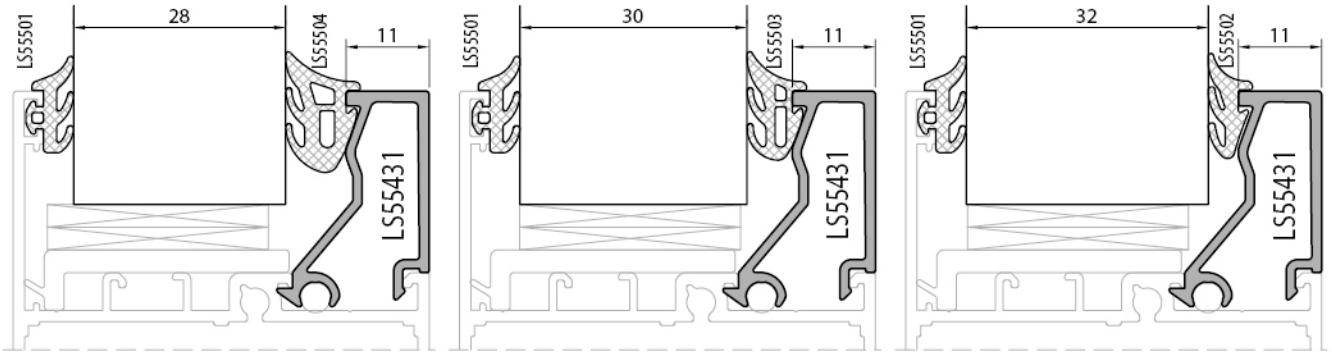
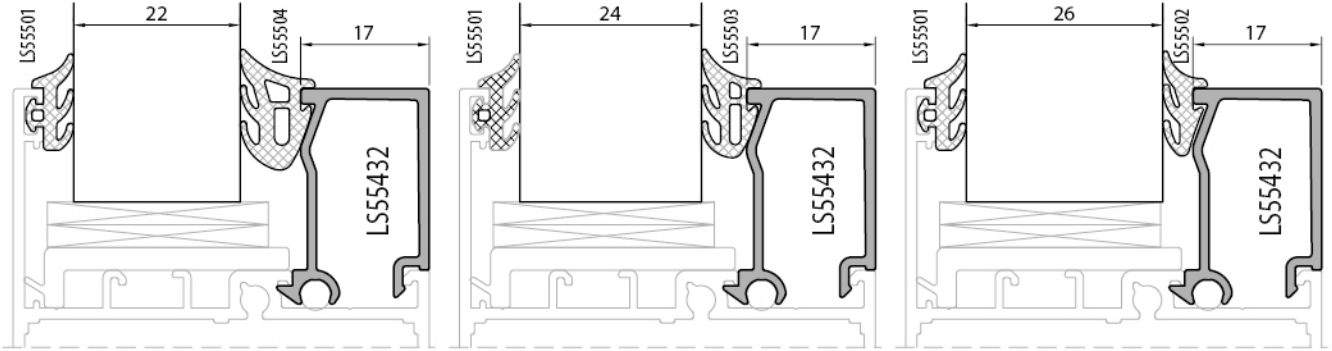

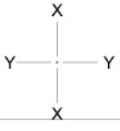

W55 PENCERE VE KAPI SİSTEM / WINDOW AND DOOR SYSTEM

ÜRÜN TEKNİK ÖZELLİKLERİ / PRODUCT TECHNICAL FEATURES

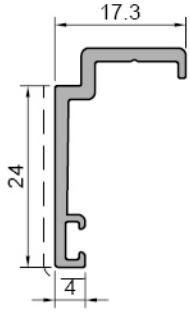

Cam Dış Çerçeve Profili
Glass outer frame profile

W55+15.420

Weight : 0,225 kg/m

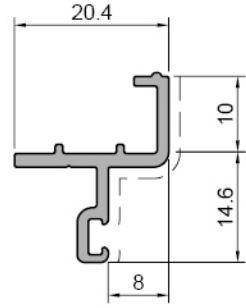
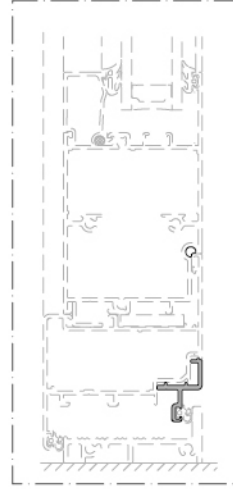
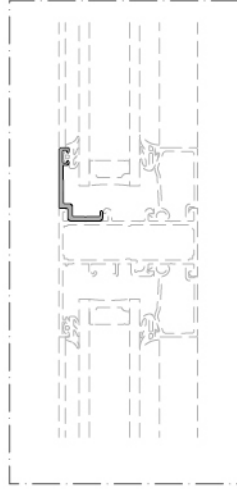

Kapı Altı Adaptör Profili
Bottom door adapter profile

W55+15.421

Weight : 0,225 kg/m

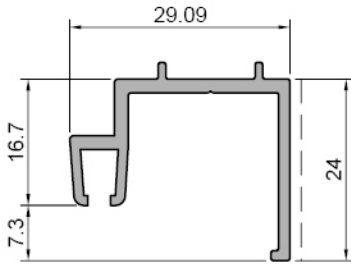

Kapı Altı Adaptör Profili
Bottom door adapter profile

W55+15.422

Weight : 0,337 kg/m

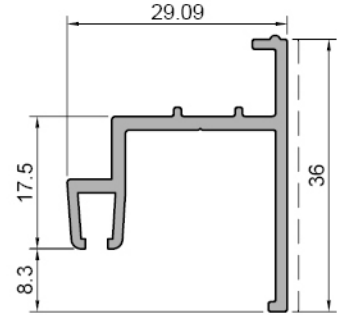
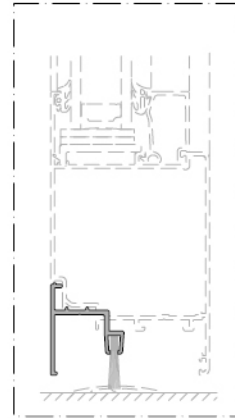
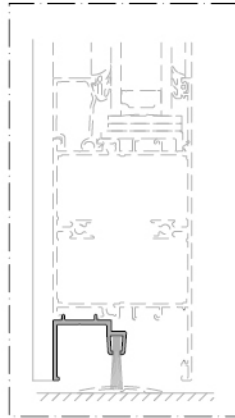

Kapı Altı Adaptör Profili
Bottom door adapter profile

W55+15.423

Weight : 0,397 kg/m

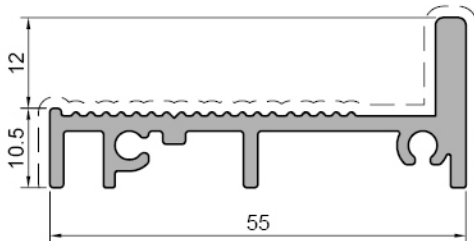

Kapı Altı Adaptör Profili
Bottom door adapter profile

W55.15.424

Weight : 0,689 kg/m

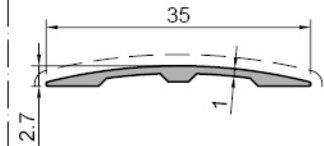
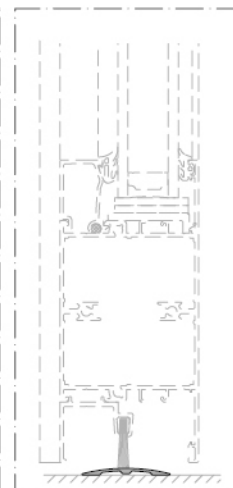
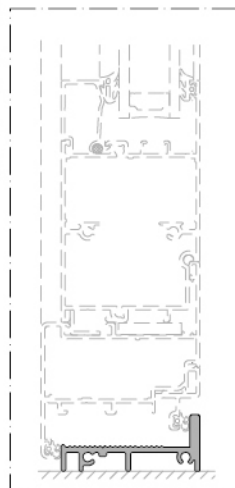

Kapı Altı Adaptör Profili
Bottom door adapter profile

W55+15.425

Weight : 0,119 kg/m

Profil değerleri teoriktir. Ağırlık olarak teslimde yapılan tartım geçerlidir. Profil imalatları TS EN 12020-02 ve TS EN 755-9 toleransı, Moment değerleri EN 14024'e göre hesaplanmıştır.
Profile values are theoretical pre-shipment weight will be valid. The tolerances of Profile manufacturing are calculated according to EN 12020-2 and TS EN 755-9; moment values are calculated according to EN 14024.

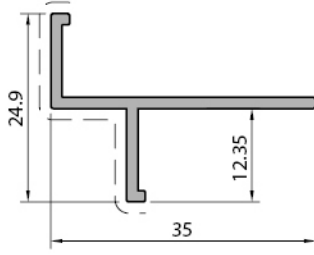
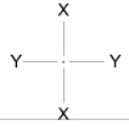

Kasa İçi Çerçeve Profili
Internal frame profile
W55+15.430
Weight : 0,250 kg/m

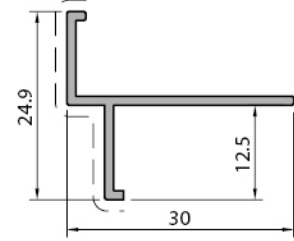
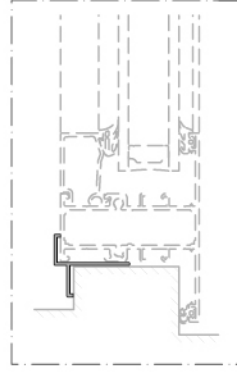

Kasa İçi Çerçeve Profili
Internal frame profile
W55+15.431
Weight : 0,185 kg/m

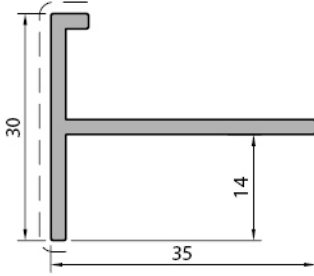

Kasa İçi Çerçeve Profili
Internal frame profile
W55+15.432
Weight : 0,360 kg/m

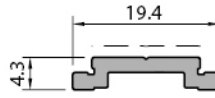

Tij Profili
Rod profile
W55+15.434
Weight : 0,130 kg/m

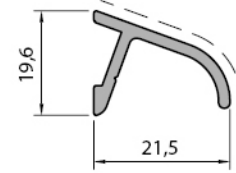

Damlalık Profili
Drip profile
W55+15.435
Weight : 0,143 kg/m

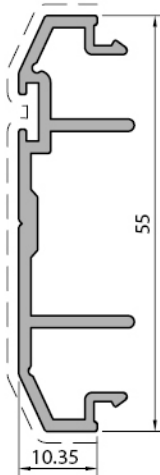

Çarpma Kapı Adaptör Profili
Impact door adapter profile
W55.15.460
Weight : 0,360 kg/m

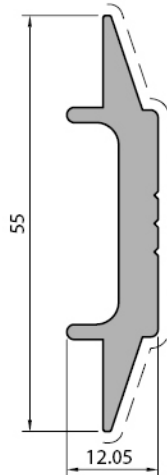

Çarpma Kapı Adaptör Profili
Impact door adapter profile
W55.15.461
Weight : 0,360 kg/m

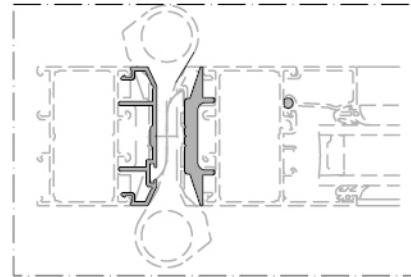

W55 PENCERE VE KAPI SİSTEM / WINDOW AND DOOR SYSTEM

ÜRÜN TEKNİK ÖZELLİKLERİ / PRODUCT TECHNICAL FEATURES

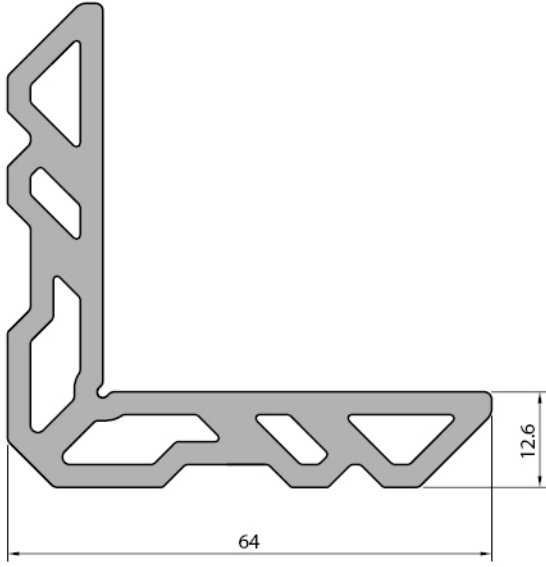

Kasa-Kanat Köşe Takoz Profili <i>Frame-sash corner cleat profile</i>
W55.450
Weight : 2,356 kg/m
W55.450-5 50,6 mm
W55.450-6 39 mm

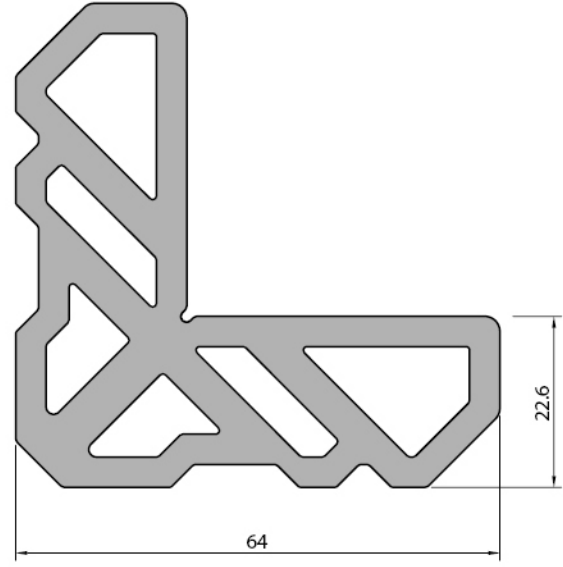

Kasa-Kanat Köşe Takoz Profili <i>Frame-sash corner cleat profile</i>
W55.451
Weight : 3,694 kg/m
W55.451-5 50,6 mm
W55.451-6 39 mm

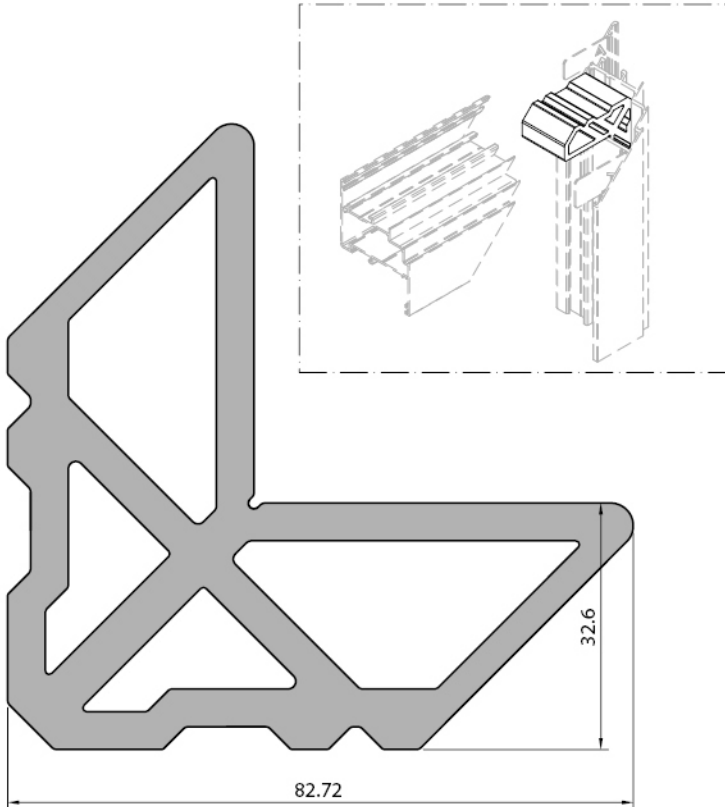

Kasa-Kanat Köşe Takoz Profili <i>Frame-sash corner cleat profile</i>
W55.452
Weight : 4,909 kg/m
W55.452-5 50,6 mm
W55.452-6 39 mm

Profil değerleri teoriktir. Ağırlık olarak teslimde yapılan tartım geçerlidir. Profil imalatları TS EN 12020-02 ve TS EN 755-9 toleransı, Moment değerleri EN 14024'e göre hesaplanmıştır.
Profile values are theoretical pre-shipment weight will be valid. The tolerances of Profile manufacturing are calculated according to EN 12020-2 and TS EN 755-9; moment values are calculated according to EN 14024.

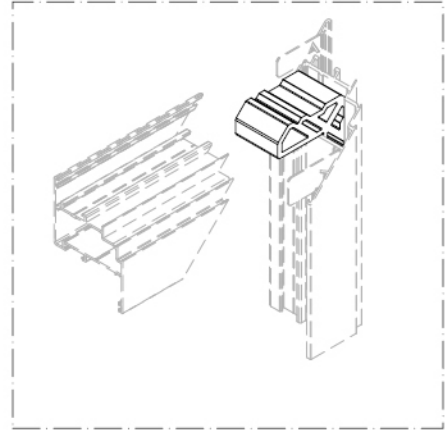
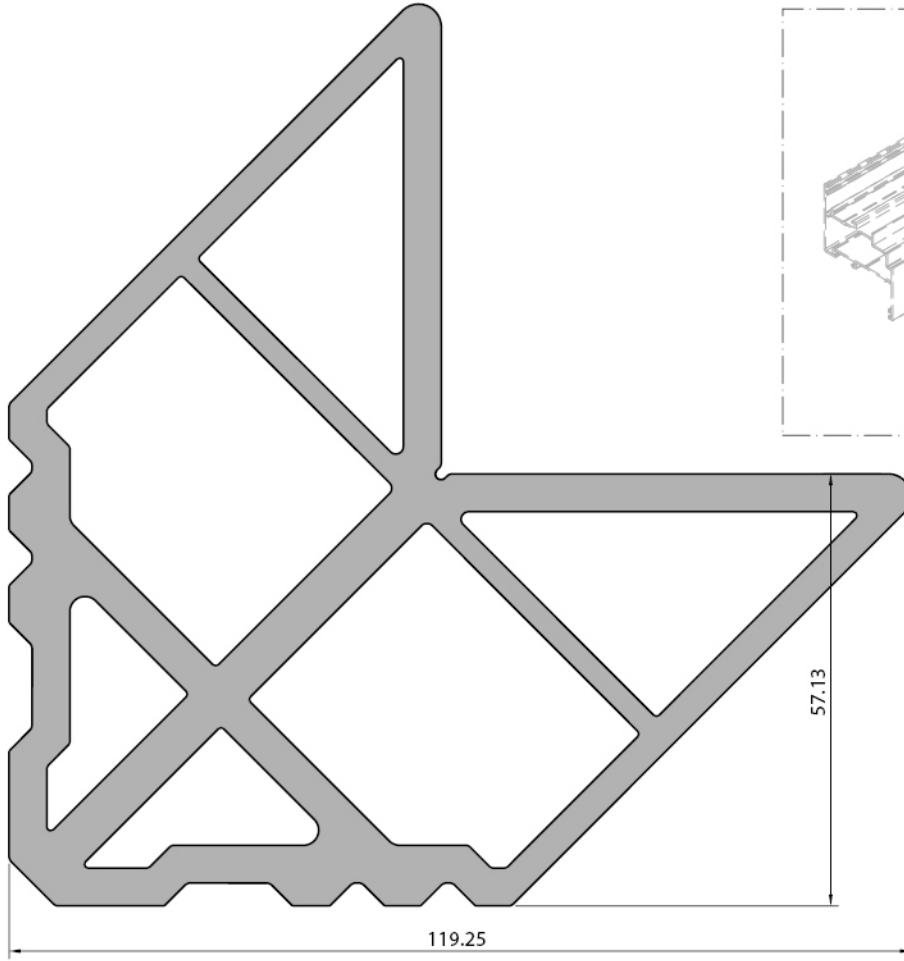

Kasa-Kanat Köşe Takoz Profili <i>Frame-sash corner cleat profile</i>	
W55.454	
Weight : 7,665 kg/m	
W55.454-4	39 mm
W55.454-5	43,5 mm

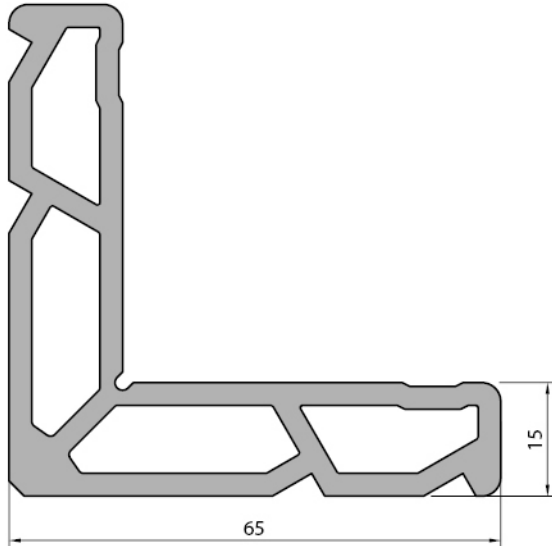

Kasa-Kanat Köşe Takoz Profili <i>Frame-sash corner cleat profile</i>	
W55.456	
Weight : 2,327 kg/m	
W55.456-1	54,9 mm

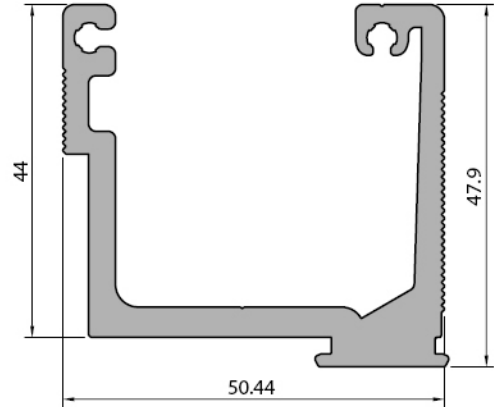

Orta Kayıt Bağlantı <i>Mullion connection</i>	
W55.15.456	
Weight : 1,582 kg/m	
W55.15.456-1	12,5 mm
W55.15.456-2	22,5 mm
W55.15.456-3	32,6 mm
W55.15.456-4	25 mm

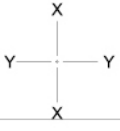

W55 PENCERE VE KAPI SİSTEM / WINDOW AND DOOR SYSTEM

ÜRÜN TEKNİK ÖZELLİKLERİ / PRODUCT TECHNICAL FEATURES

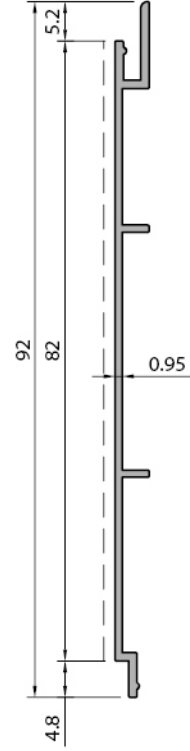
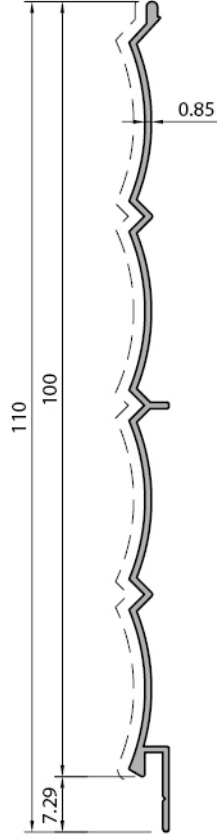
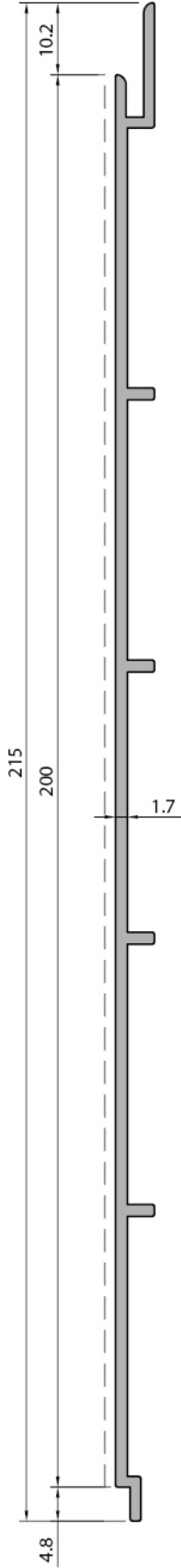

Lambri Profili
Wainscot profile

W55+15.437

Weight : 0,305 kg/m

Lambri Profili
Wainscot profile

W55+15.438

Weight : 0,295 kg/m

Lambri Profili
Wainscot profile

W55+15.436

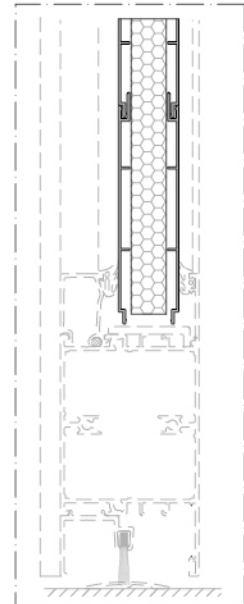

Weight : 1,095 kg/m

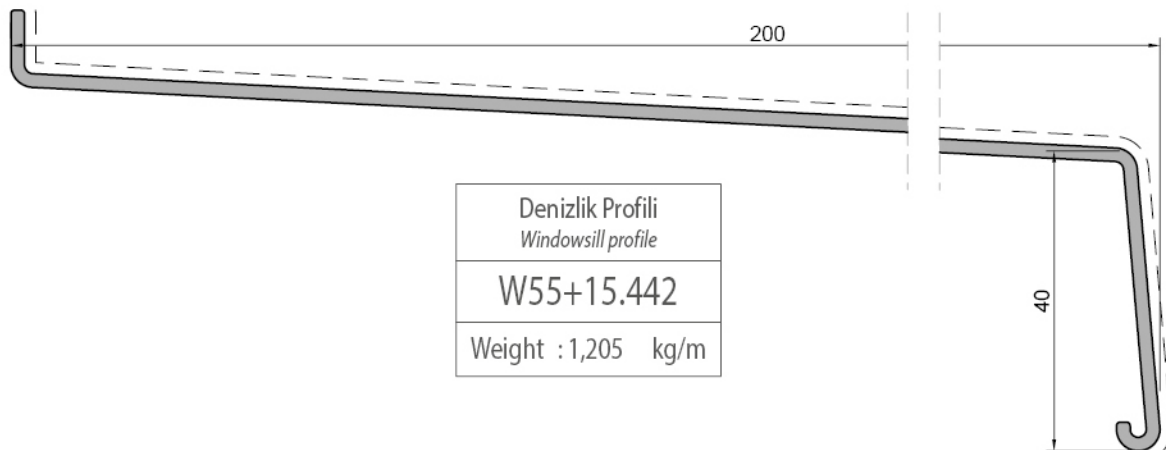
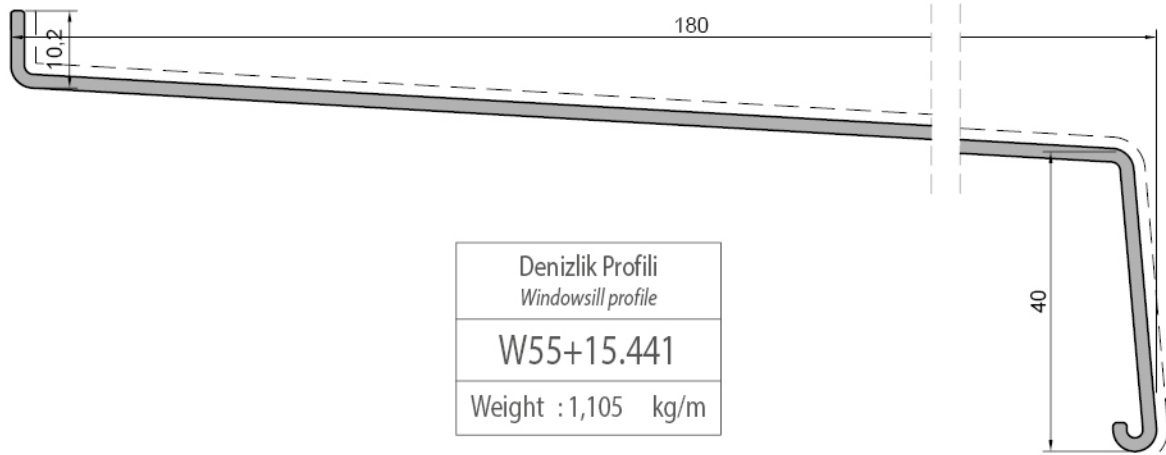
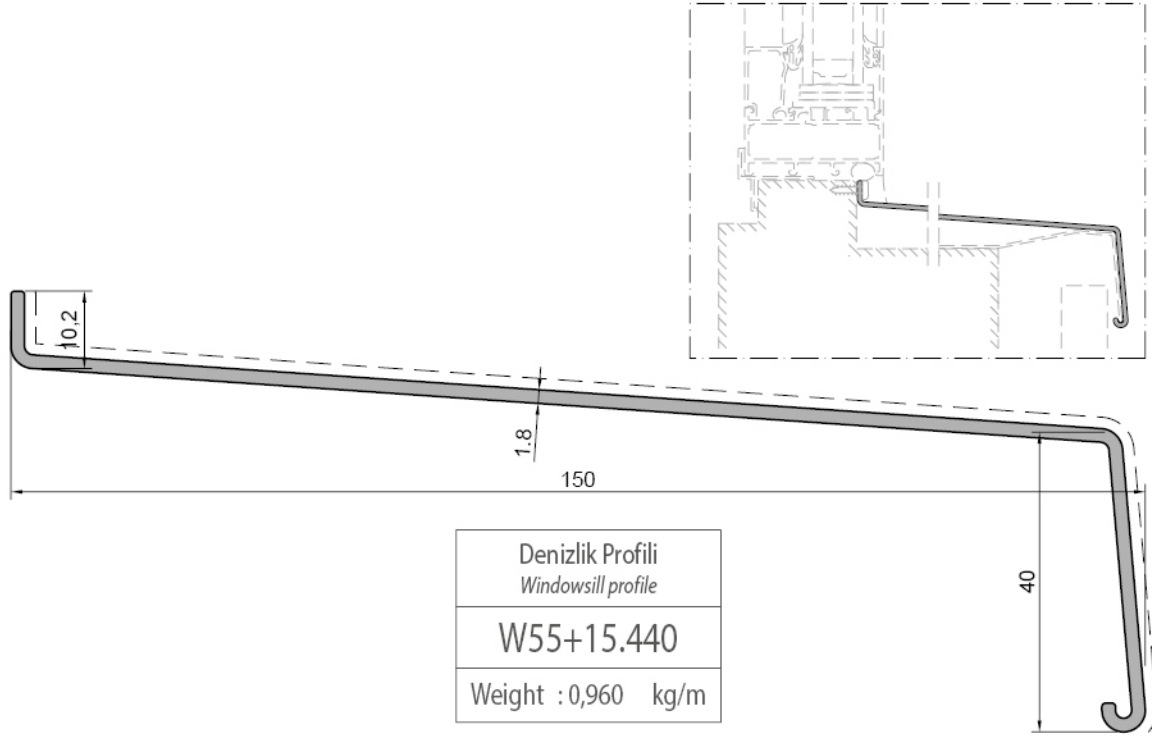
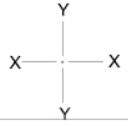





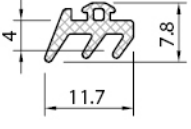
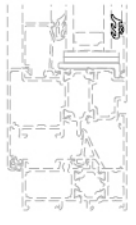
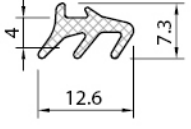
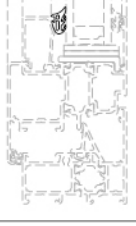
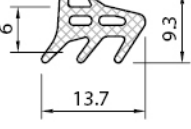
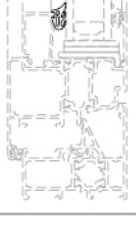
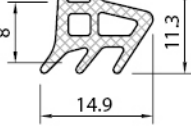
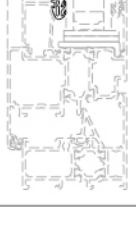
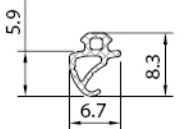

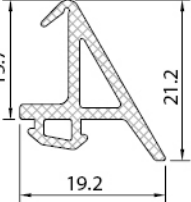
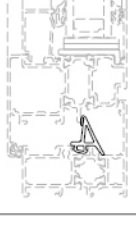
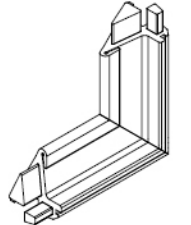
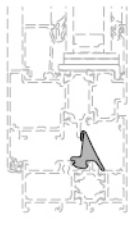
W55 PENCERE VE KAPI SİSTEM / WINDOW AND DOOR SYSTEM

ÜRÜN TEKNİK ÖZELLİKLERİ / PRODUCT TECHNICAL FEATURES

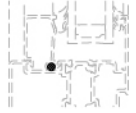
Kod Code	Şekil Drawing	Tanım Description	Teorik Ağırlık Theoretical Weight gr / m	Paket Ağırlığı Package Weight Kg / Package	Paket Metrajı In one Package Metre / Package	Kullanım Yeri Application
LS55501		epdm cam dış fitil glazing gasket outside	55 gr/m	12 kg	220 m	
LS55502		epdm cam iç fitil glazing gasket inside	52 gr/m	12 kg	230 m	
LS55503		epdm cam iç fitil glazing gasket inside	80 gr/m	12 kg	150 m	
LS55504		epdm cam iç fitil glazing gasket inside	92 gr/m	12 kg	130 m	
W55.501		epdm iç bini fitil inside acoustic gasket	26 gr/m	12 kg	460 m	
W55.502		epdm tozluk içv fitil epdm central gasket	147 gr/m	10 kg	68 m	
W55.503		epdm tozluk iç fitil vulkanize köşe epdm central gasket vulcanised corner	--	--	50 ad./pk 50 pcs/pk	

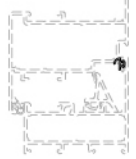
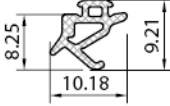
Profil değerleri teoriktir. Ağırlık olarak teslimde yapılan tartım geçerlidir. Profil imalatları TS EN 12020-02 ve TS EN 755-9 tolaransı, Moment değerleri EN 14024'e göre hesaplanmıştır.
Profile values are theoretical pre-shipment weight will be valid. The tolerances of Profile manufacturing are calculated according to EN 12020-2 and TS EN 755-9; moment values are calculated according to EN 14024.

Kod Code	Şekil Drawing	Tanım Description	Teorik Ağırlık Theoretical Weight gr / m	Paket Ağırlığı Package Weight Kg / Package	Paket Metrajı In one Package Metre / Package	Kullanım Yeri Application
W55.511		epdm fitil epdm gasket	18 gr/m	10 kg	555 m	
W55.514		epdm dış bini fitil outside acoustic gasket	19 gr/m	10 kg	526 m	
W55.515		epdm iç bini fitil inside acoustic gasket	26 gr/m	12 kg	460 m	

W55 PENCERE VE KAPI SİSTEM / WINDOW AND DOOR SYSTEM

ÜRÜN TEKNİK ÖZELLİKLERİ / PRODUCT TECHNICAL FEATURES

Kod Code	Şekil Drawing	Tanım Description	Paket Metraji In one Package Metre / Package	Kullanım Yeri Application
W55.606		çift kanat adaptör kapak <i>adapter cover for double sash euro groove (set)</i>	20 pcs/pk	
LS55614		su tahliye kapağı <i>water drainage plug</i>	200 pcs/pk	
LS55617		köşe onbaşı <i>corner cleat</i>	200 pcs/pk	
LS55618		köşe onbaşı <i>corner cleat</i>	200 pcs/pk	
W55.610		pvc cam destek takoz <i>pvc glazing support cleat</i>	3,0 m 20 pcs/pk	
LS55521		perdeli fırça fitil <i>webbed brush gasket</i>	250 m/pk	

Profil değerleri teoriktir. Ağırlık olarak teslimde yapılan tartım geçerlidir. Profil imalatları TS EN 12020-02 ve TS EN 755-9 toleransı, Moment değerleri EN 14024'e göre hesaplanmıştır.
Profile values are theoretical pre-shipment weight will be valid. The tolerances of Profile manufacturing are calculated according to EN 12020-2 and TS EN 755-9; moment values are calculated according to EN 14024.

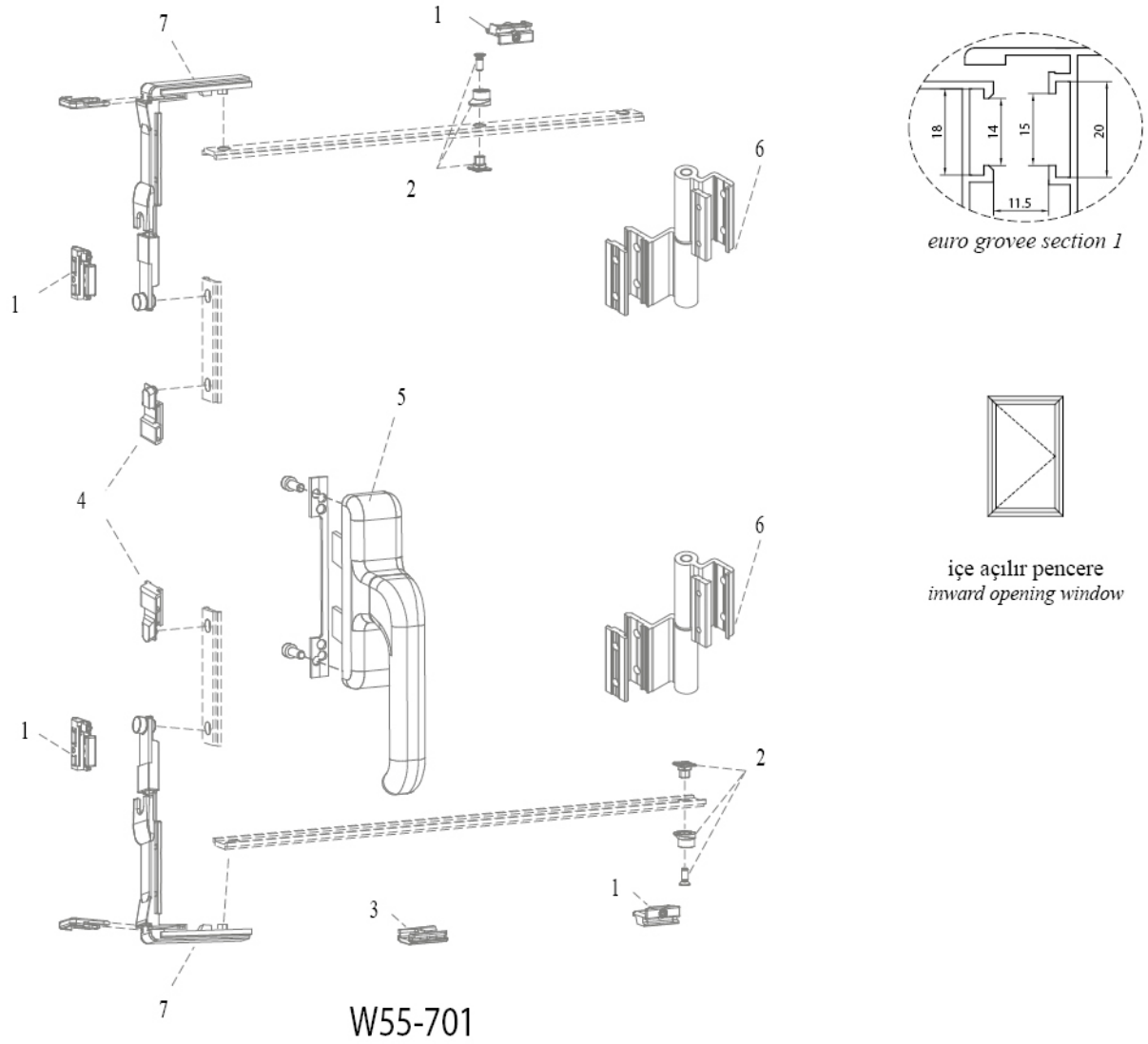

Normal açılım mekanizması (takım)
Opening window mechanism (set)

W55-701	1	Pim karşılığı	W55-731
	2	Ayarlı karşılık	W55-733
	3	Kanat sarkma takozu	W55-740
	4	Tij bağlantı pabucu	W55-732
	5	Çift dilli kol	W55-761
	6	Menteşe	W55-770
	7	Köşe dönme	W55-730



Renk seçeneği belirtilmelidir.
By selecting colors, it must be informed.

W55 PENCERE VE KAPI SİSTEMİ / WINDOW AND DOOR SYSTEM

ÜRÜN TEKNİK ÖZELLİKLERİ / PRODUCT TECHNICAL FEATURES

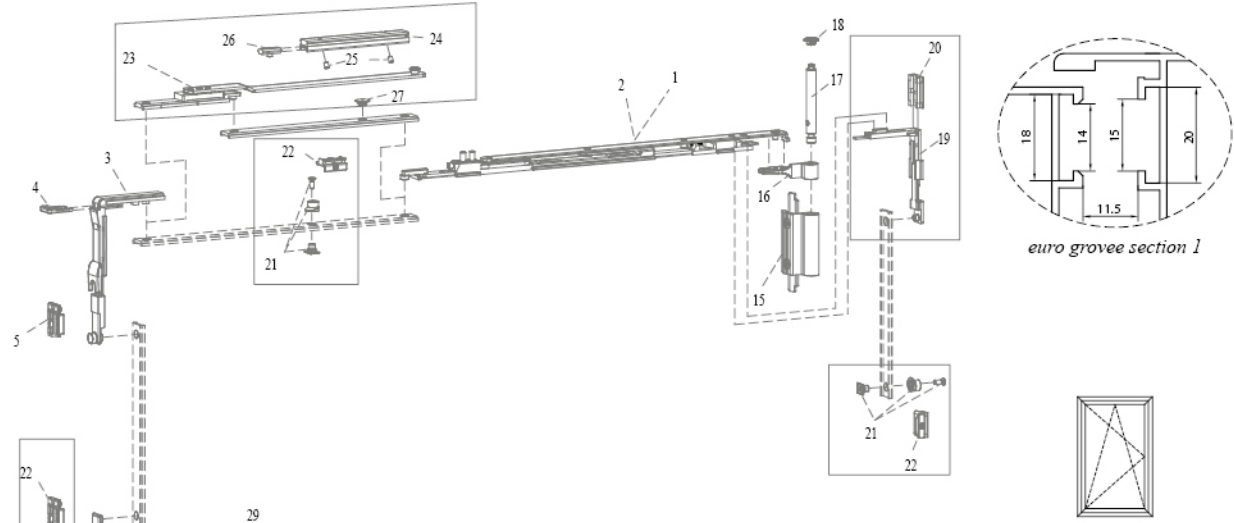

euro groove section 1

içe açılır pencere
inward opening window

Çift açılım mekanizması (takım)

Tilt and turn window mechanism (set)

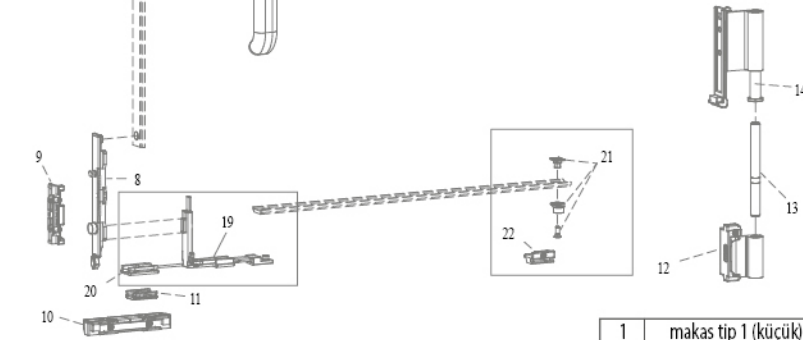

W55.702 (80kg)

W55.702-1 (80kg)

ithal (import)

W55.703 (130kg)

W55.703-1 (130kg)

ithal (import)

	(80 kg)	(130 kg)	
1	makas tip 1 (küçük)	W55-738-80	W55-738-130
2	makas tip 2 (büyük)	W55-739-80	W55-739-130
3	köşe dönme		
4	köşe dönme sabitleme klipsi		
5	karşılık		
6	kol karşılığı		
7	hatalı kullanım öneme karşılığı	W55-722	W55-722
8	8-10mm ayar şimi		
9	sürgü		
10	karşılık		
11	çift sürgü karşılık		
12	dinlendirme takozu		
13	dip menteşe erkek kısmı		
14	dip menteşe pimi		
15	üst menteşe diş kısmı	W55-721	W55-720
16	üst menteşe erkek kısmı		
17	üst menteşe diş kısmı		
18	üst menteşe pimi		
19	üst menteşe stoper kapak		
20	euro 900 çift açılım kolu	W55-763	W55-763
21		+	+
22		> 80kg	> 130kg

ILAVE ARKA KİLİTLEME			
19	ilave köşe dönme		
20	ilave köşe dönme sabitleme klipsi		
21	kilitleme pimi	W55-723	W55-723
22	ayarlı karşılık		
ILAVE MAKAS			
23	ilave makas		
24	ilave makas kılavuzu		
25	klavuz vidaları		W55-735
26	ayarlı stoper		
27	makas destek bloğu		



Renk seçeneği belirtilmemiştir.
By selecting colors, it must be informed.

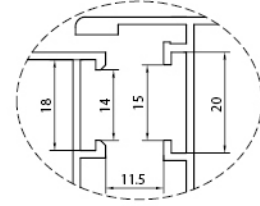
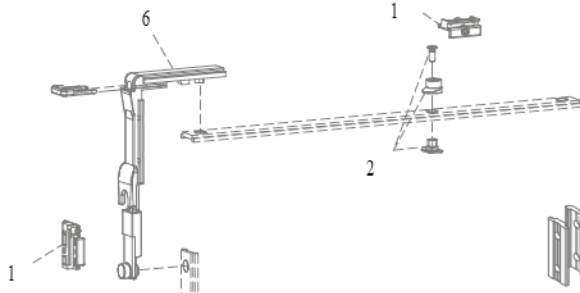

euro groove section 1

Normal açılım mekanizması (takım)

Opening window mechanism (set)

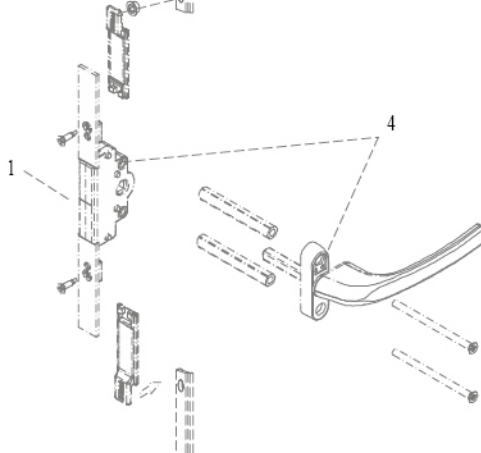

dışa açılır pencere
outward opening window

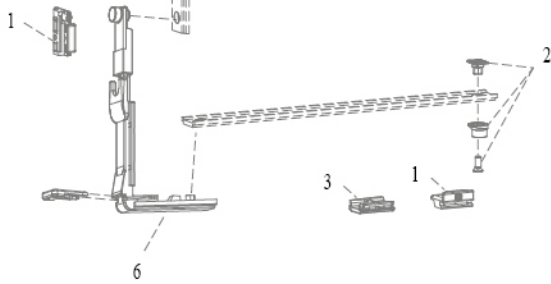

W55-706

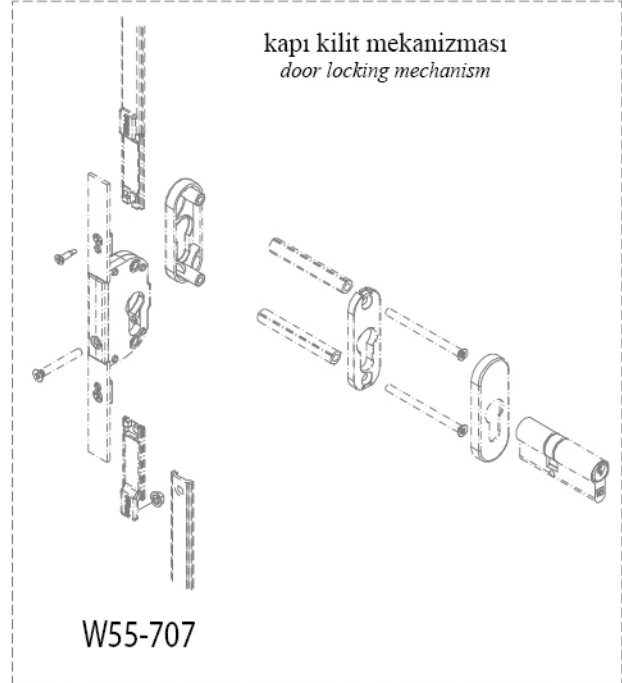

kapı kilit mekanizması
door locking mechanism

W55-707



Renk seçeneği belirtilmelidir.
By selecting colors, it must be informed.

W55-706	1	Pim karşılığı	W55-731
	2	Ayarlı karşılık	W55-733
	3	Kanat sarkma takozu	W55-740
	4	Mekanizma+kol	W55-748
	5	Menteşe	W55-770
	6	Köşe dönme	W55-730

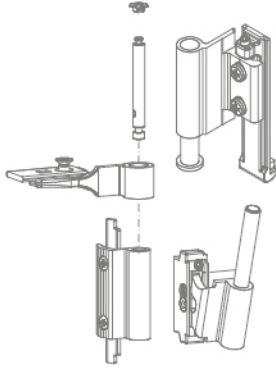

Çift açılım pencere üst menteşesi (130kg)
Tilt and turn window top hinge (130kg)

W55.720

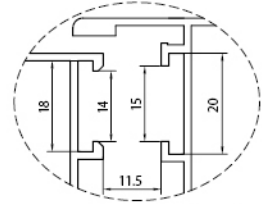

euro groove section 1

Çift açılım pencere üst menteşesi (80kg)
Tilt and turn window top hinge (80kg)

W55.721

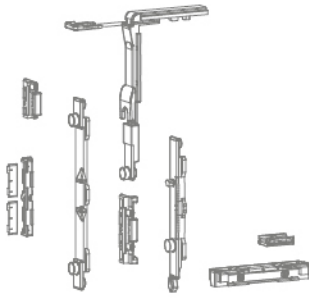
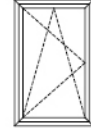

Çift açılım kilitleme mekanizması
Tilt and turn base mechanism

W55.722



Renk seçeneği belirtilmelidir.
By selecting colors, it must be informed.

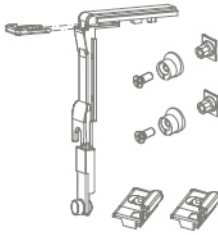

Çift açılım ilave kilitleme
Tilt and turn annex set

W55.723

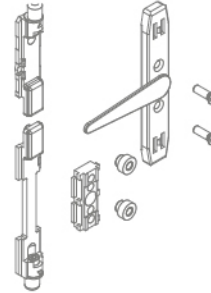

İkinci kanat sürgü seti
Two-way lever push bolt

W55.724



Köşe hareket aktarıcı
Corner transmission for window

W55.730



Pim karşılığı
Adjustable single striker

W55.731

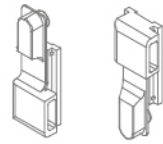

Tij bağlantı pabucu
Connection blocks

W55.732



Pim
Pin

W55.733



Ayarlanabilir pim
Adjustable fastening pawl

W55.734

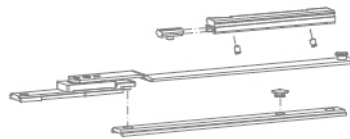

Çift açılım ilave makas
Tilt and turn annex arm

W55.735



Kol karşılığı
Cremona drive

W55.736



Sürgü ucu
Bolt tip

W55.737

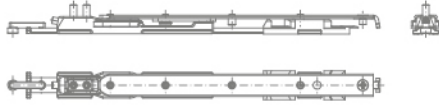

Çift açılım küçük makas (80kg)
Tilt and turn short arm (80kg)
W55.738-80

Çift açılım küçük makas (130kg)
Tilt and turn short arm (130kg)
W55.738-130

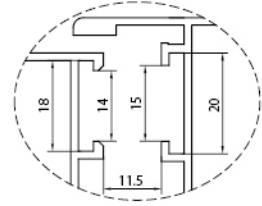

euro groove section 1

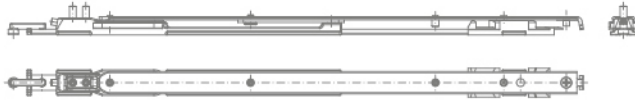

Çift açılım büyük makas (80kg)
Tilt and turn long arm (80kg)
W55.739-80

Çift açılım büyük makas (130kg)
Tilt and turn long arm (130kg)
W55.739-130

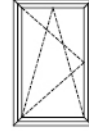

Kanat sarkma takozu
Sash rise stopper
W55.740



Çiftli sürgü karşılığı
Double keeper
W55.741



Kanat düşüş karşılığı
Sash drop keeper
W55.742



Kademeli teleskopik makas (inox)
Stepped telescopic arm
W55.743



Vasistas makası
Arm for bottom-hung window
W55.744



Vasistas çit çit
Catch for bottom-hung window
W55.745

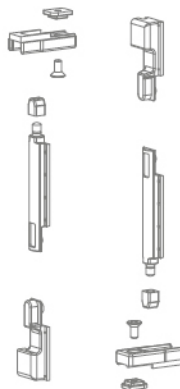

Kapı sürgüsü
Door lever bolt
W55.746



Kapı altı fırçası
Door brush
W55.747

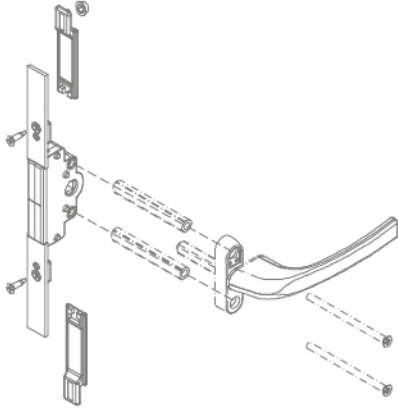

Dışa açılır pencere-kapı mekanizması
Outward opening window-door mechanism

W55.748

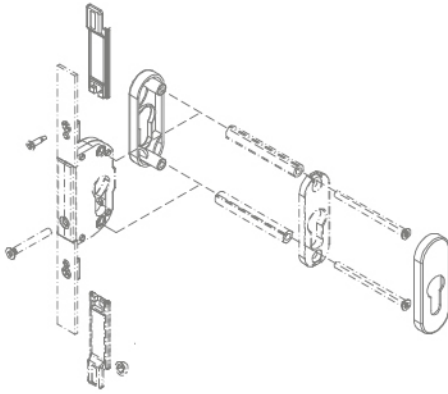

Dışa açılır kapı kilit mekanizması
Outward opening door locking mechanism

W55.749

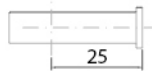

Dışa açılır kapı mekanizması
Outward opening door mechanism

W55.751

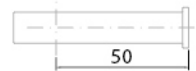

Dışa açılır kapı mekanizması
Outward opening door mechanism

W55.750

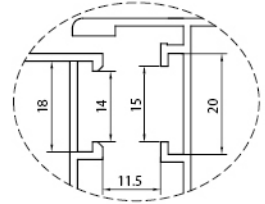

euro groove section 1



dışa açılır pencere-kapı
outward opening window-door

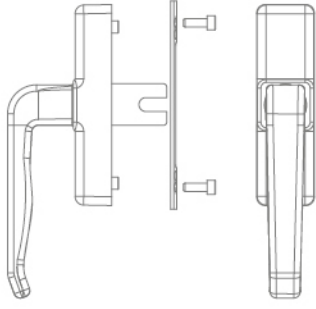

Tek maçalı normal açılım pencere kolu
Opening window handle

W55.760

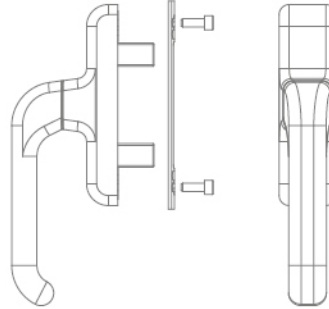

Çift maçalı normal açılım pencere kolu
Opening window handle

W55.761

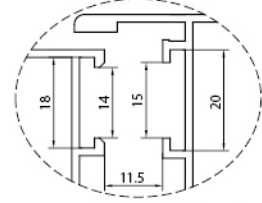

euro groove section 1

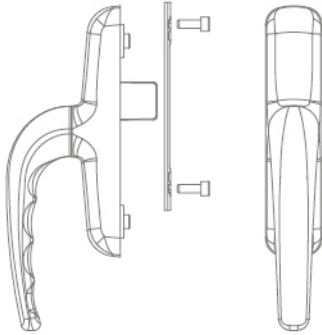
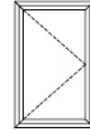

Tek maçalı normal açılım pencere kolu (ithal)
Opening window handle (import)

W55.760-1

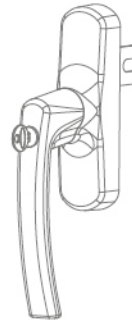

Anahtarlı eksenel kol
Key lockable window handle

W55.762



Renk seçeneği belirtilmelidir.
By selecting colors, it must be informed.

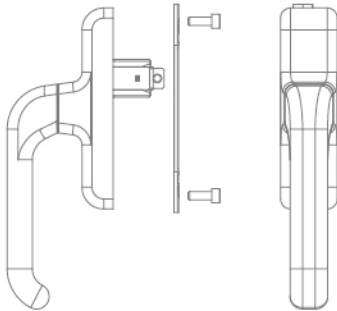

Çift açılım pencere kolu
Tilt and turn opening window handle

W55.763

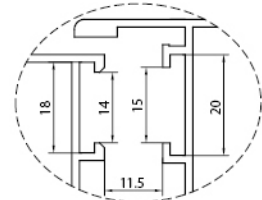
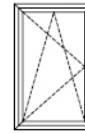

euro groove section 1

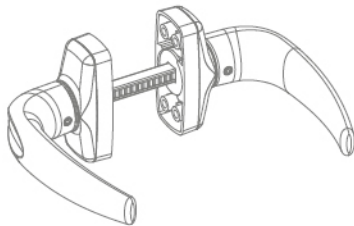

Prima kapı kolu
Prima door handle

W55.764

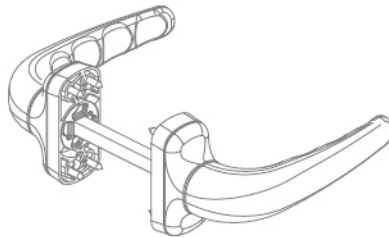

Prima kapı kolu (ithal)
Prima door handle couple (import)

W55.764-1

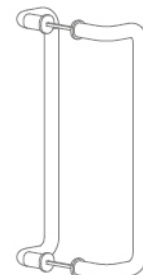

Kıvrık kapı kolu
Door handle

W55.765



Akbank kapı kolu
Door handle

W55.763

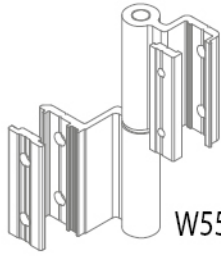

W55.770

İki yapraklı pencere menteşesi
Two leaves window hinge



max.80 kg



Renk seçeneği belirtilmelidir.
By selecting colors, it must be informed.



max.80 kg

W55.770-1
ithal (import)

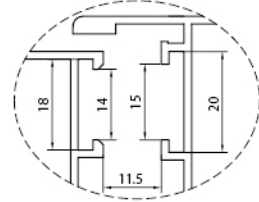

euro groove section 1

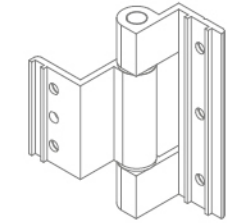

W55.771

Üç yapraklı normal açılım pencere menteşesi
Three leaves window hinge



max.80 kg



Renk seçeneği belirtilmelidir.
By selecting colors, it must be informed.

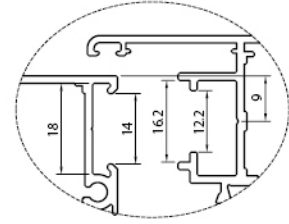

pvc groove section 9mm

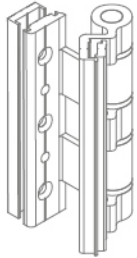
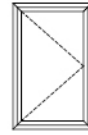

W55.773
Üç yapraklı kapı menteşesi
Three leaves door hinge



max.100 kg



Renk seçeneği belirtilmelidir.
By selecting colors, it must be informed.

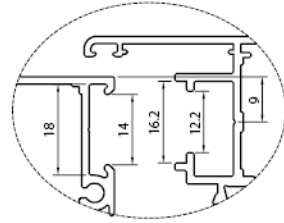

pvc groove section 9mm

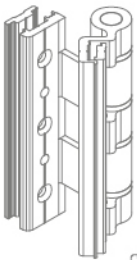

W55.774
Üç yapraklı kapı menteşesi
Three leaves door hinge



max.100 kg



Renk seçeneği belirtilmelidir.
By selecting colors, it must be informed.

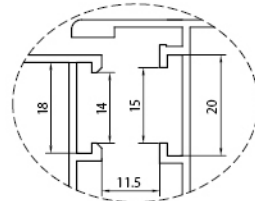

euro groove section 1

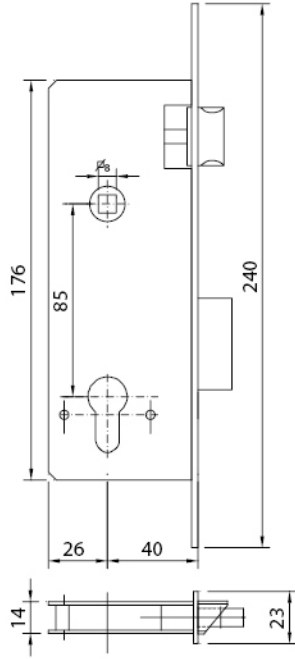

W55.780
Geniş kilit(dilli)
Wide type lock (bolt)

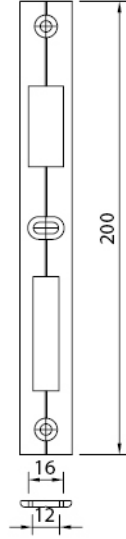

W55.781
Kilit karşılığı
Lock plate

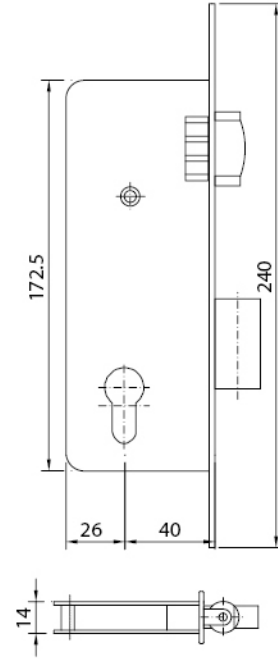

W55.782
Geniş kilit(makaralı)
Wide type lock (roller)

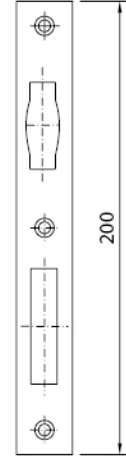

W55.783
Kilit karşılığı
Lock plate

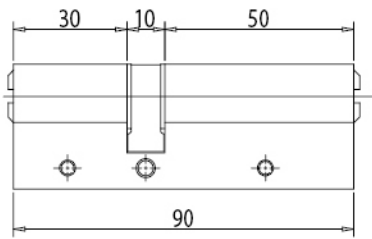

W55.784
Barel
Cylinders



W55.785
Barel rozeti
Cylinder cover

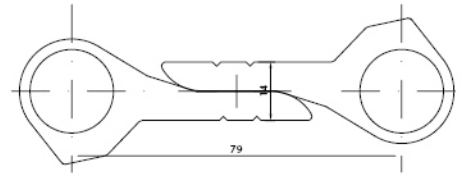

W55.786
Çarpma kapı menteşesi
Swinging door hinges

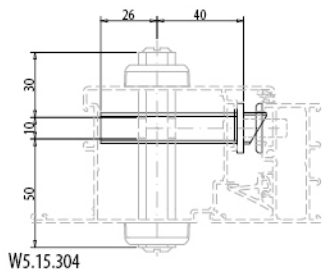

W5.15.304

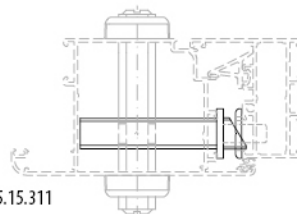

W5.15.311

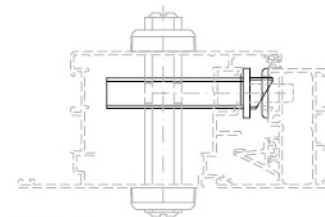

W5.15.312



Farklı renk seçeneği belirtilmelidir.
By selecting different colors, it must be informed.

W55 PENCERE VE KAPI SİSTEM
WINDOW AND DOOR SYSTEM

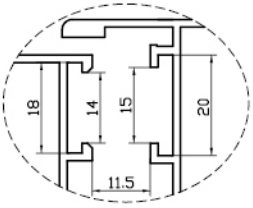
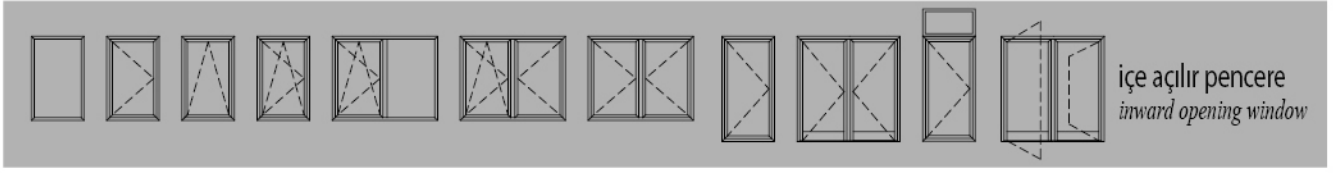

euro groove section 1

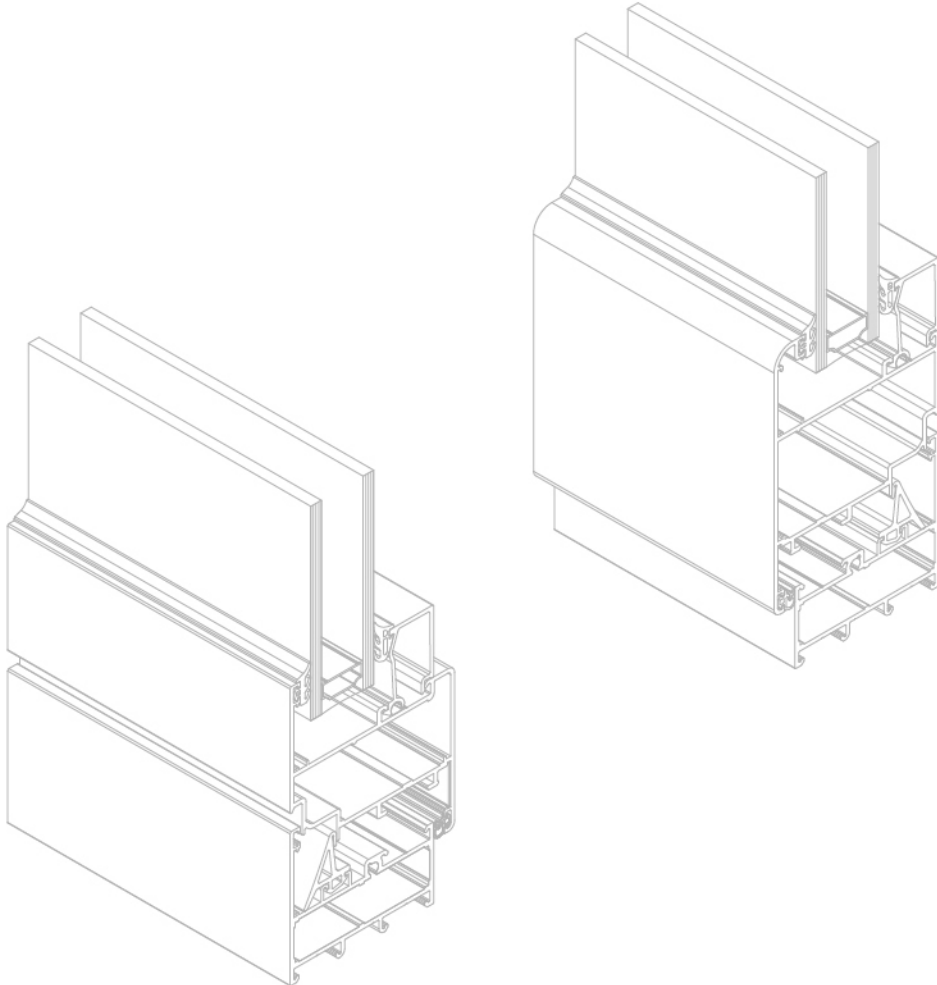

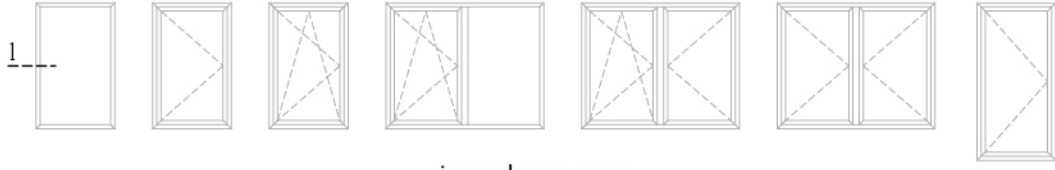

içe açılır pencere
inward opening window

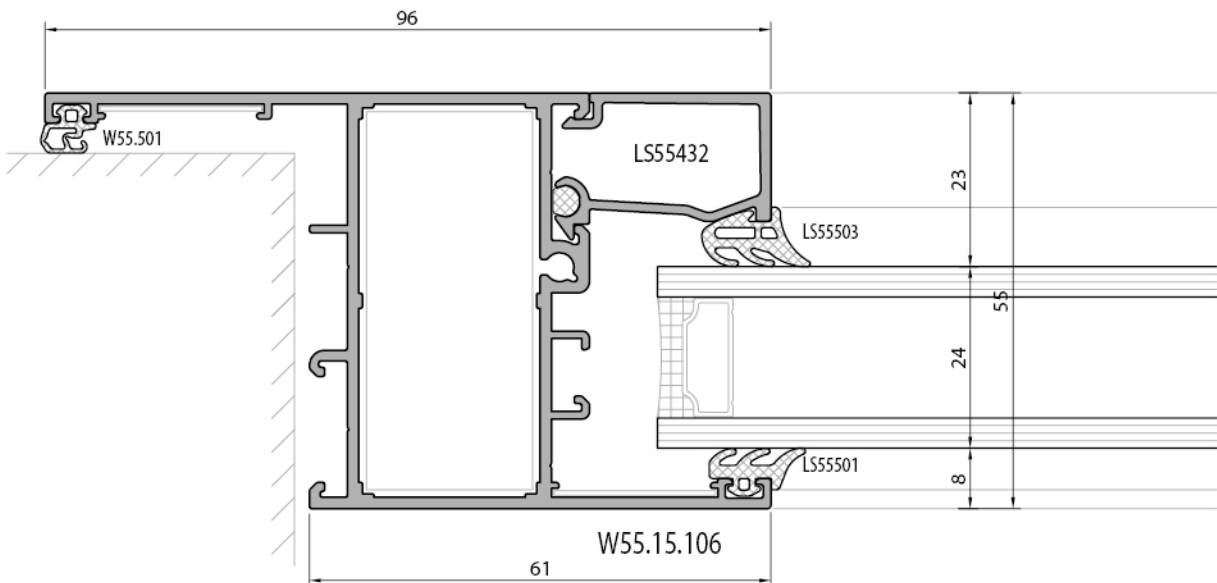
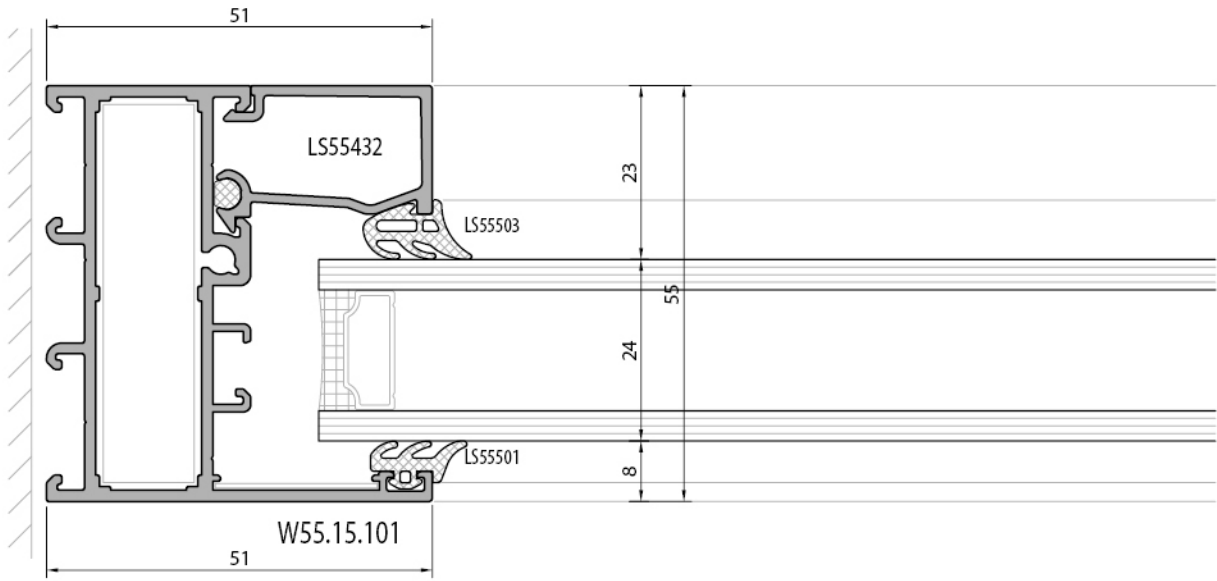

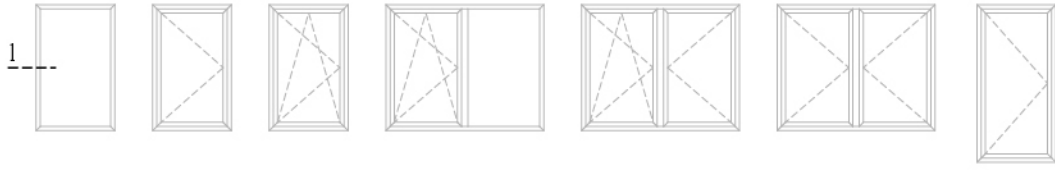

içe açılır pencere
inward opening window

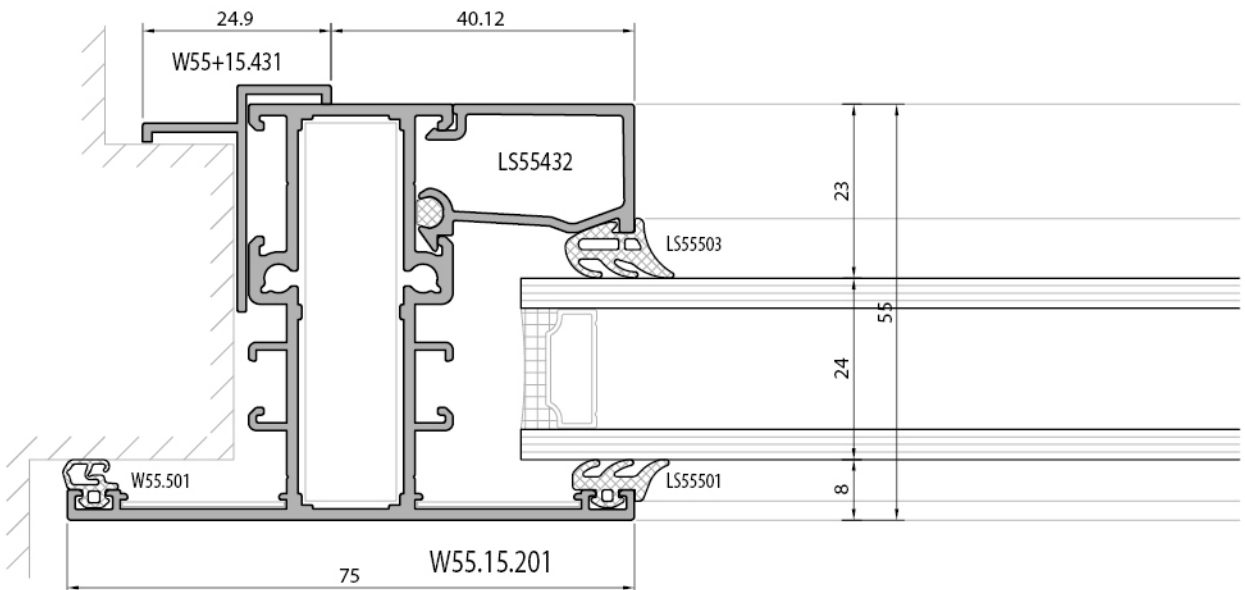
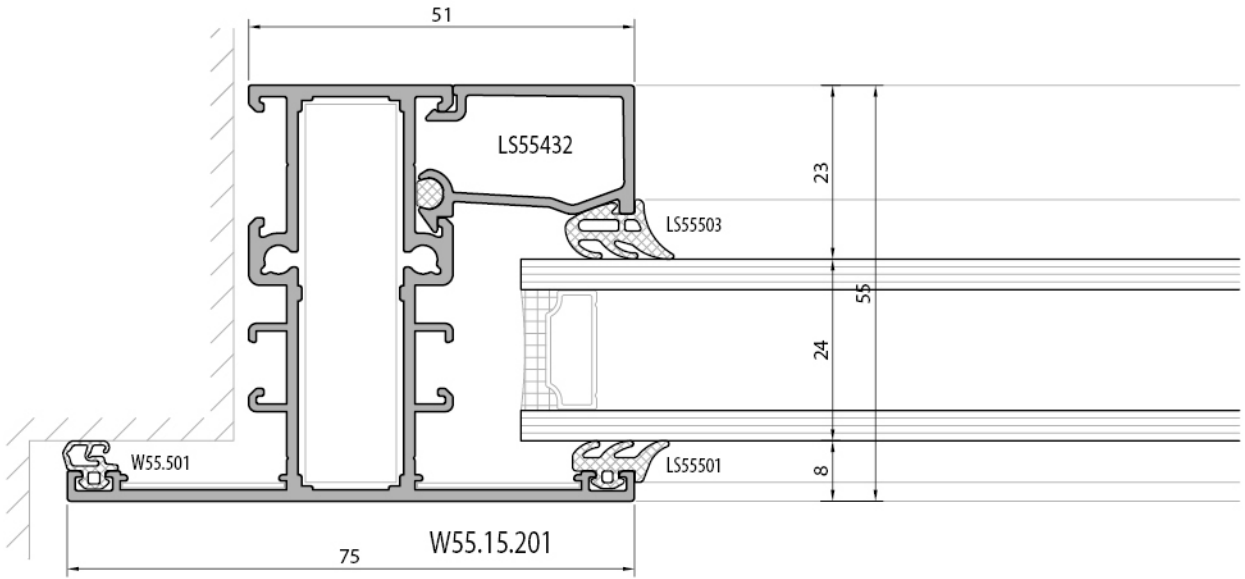

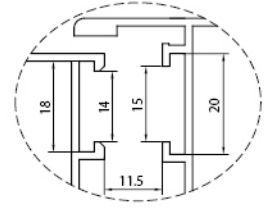
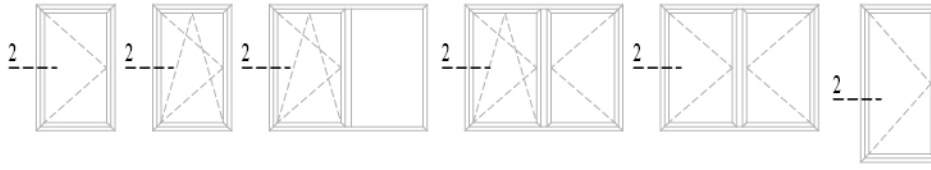

içe açılır pencere
inward opening window

euro groove section 1

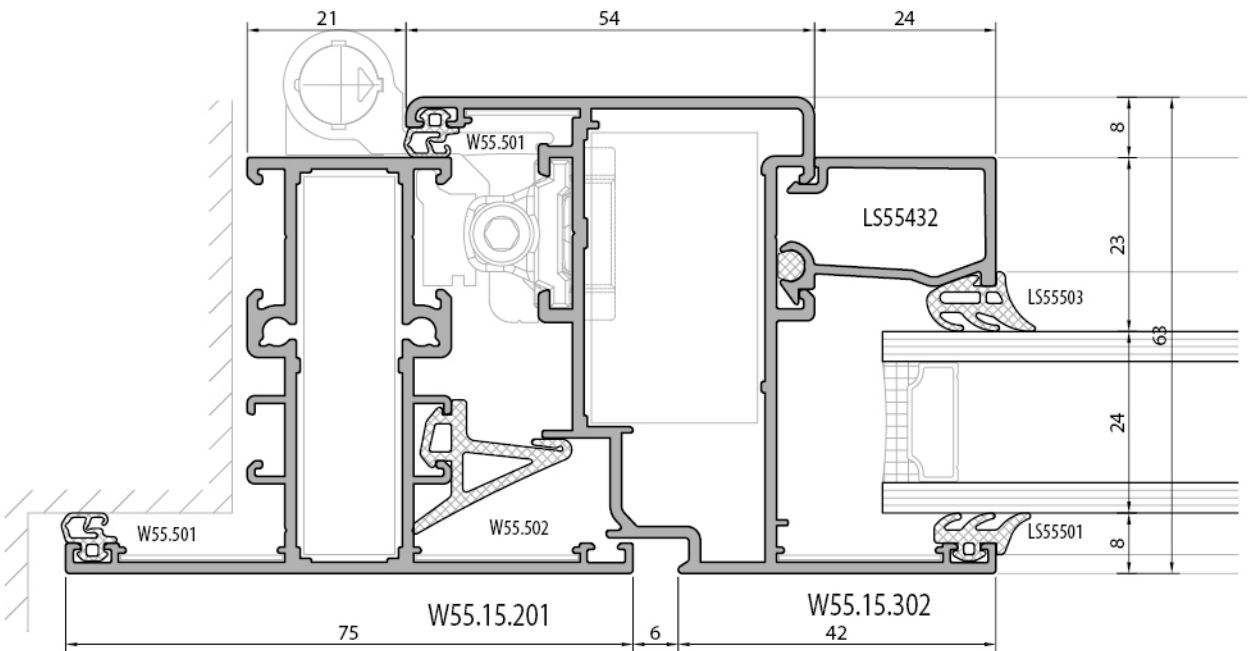
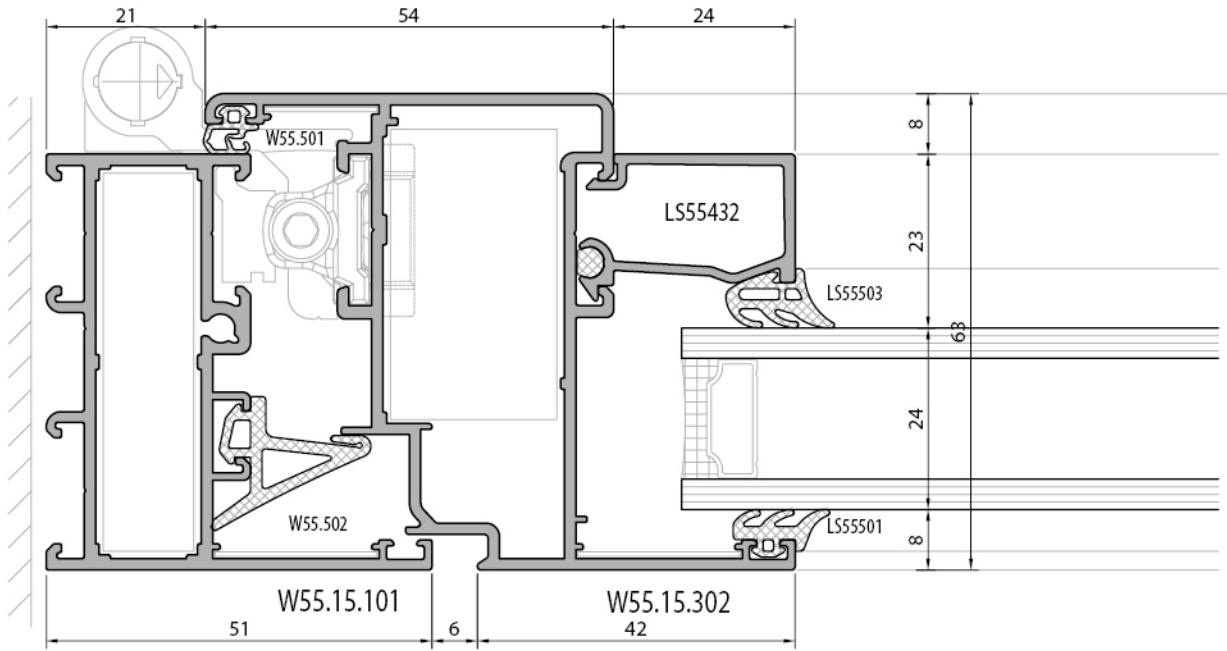

W55 PENCERE VE KAPI SİSTEMİ / WINDOW AND DOOR SYSTEM

SİSTEM DETAYLARI / SYSTEM DETAILS

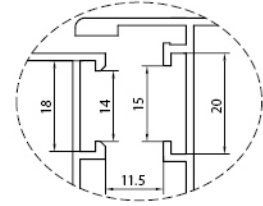
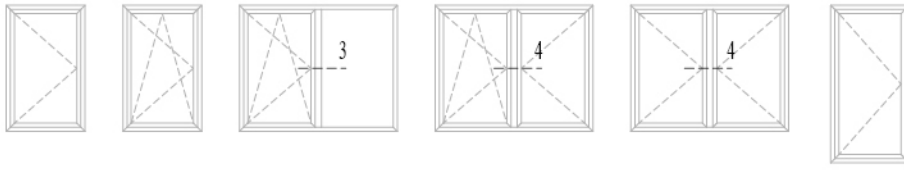

ie aılır pencere
inward opening window

euro groove section 1

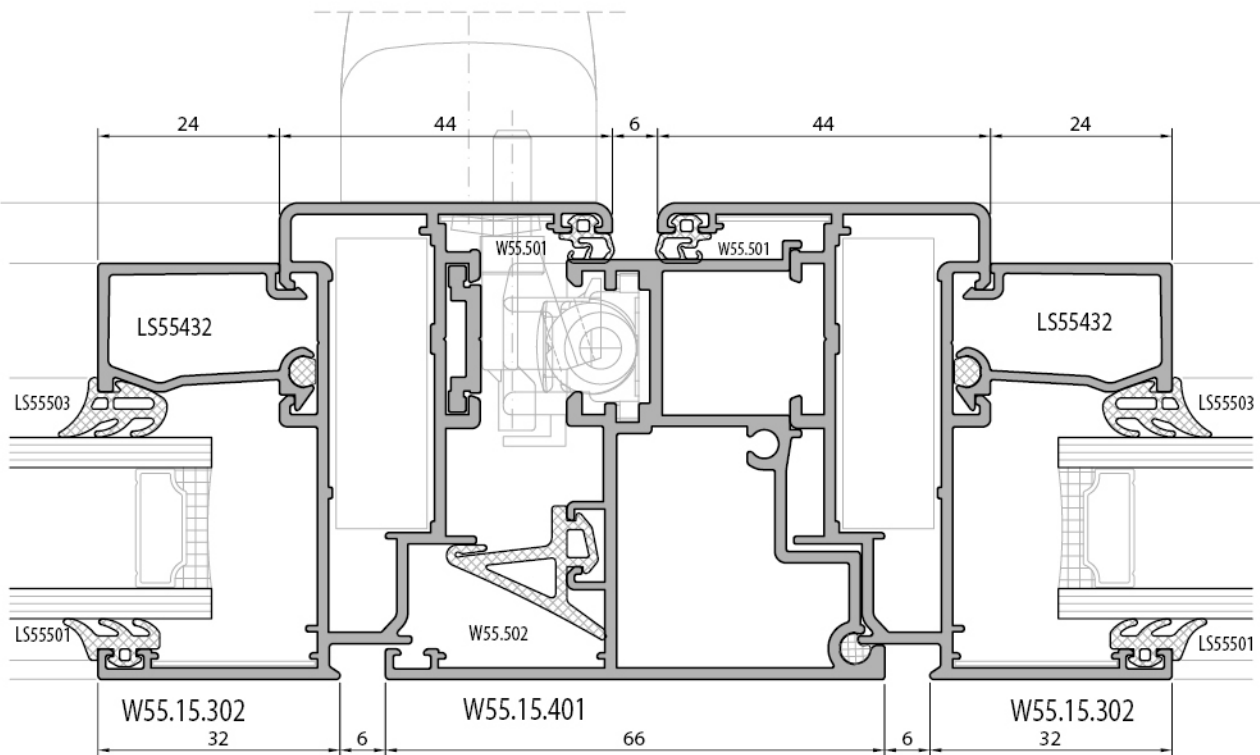
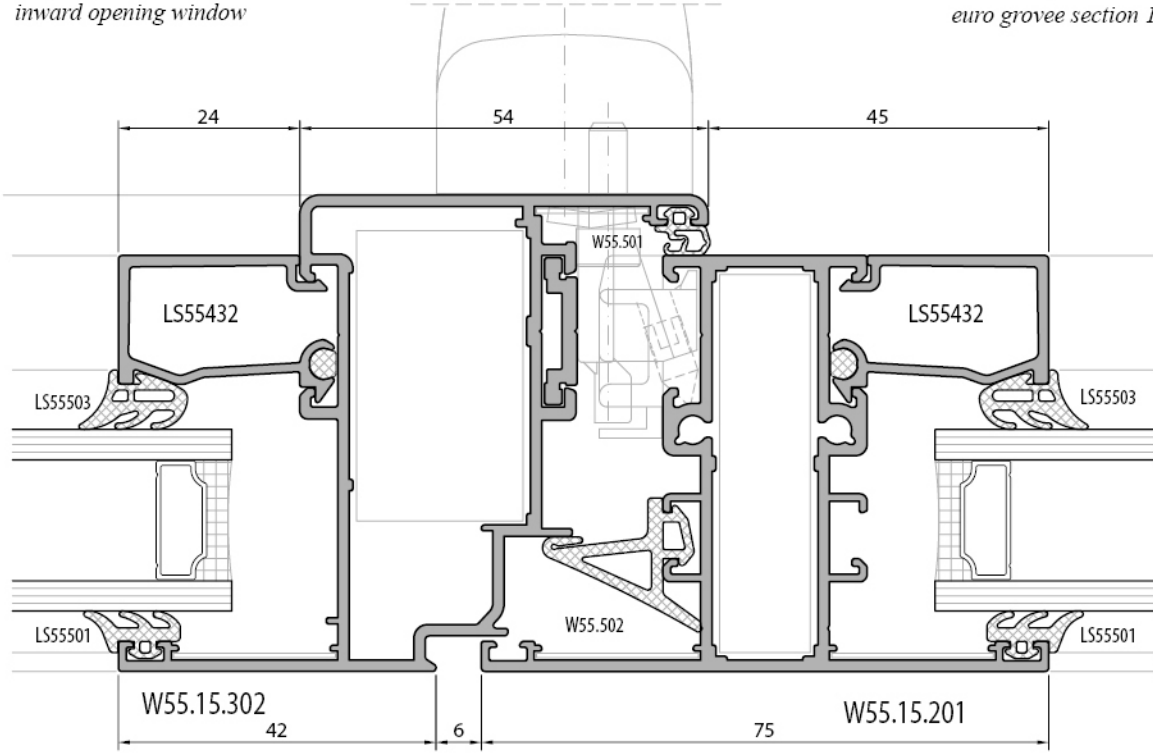

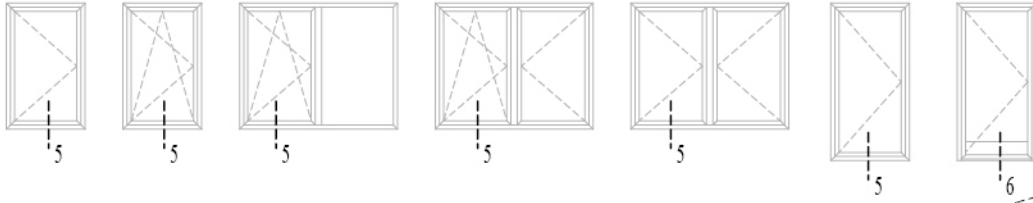

içe açılır pencere
inward opening window

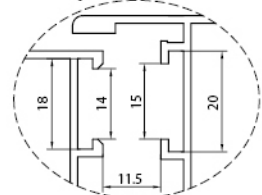

euro groove section 1

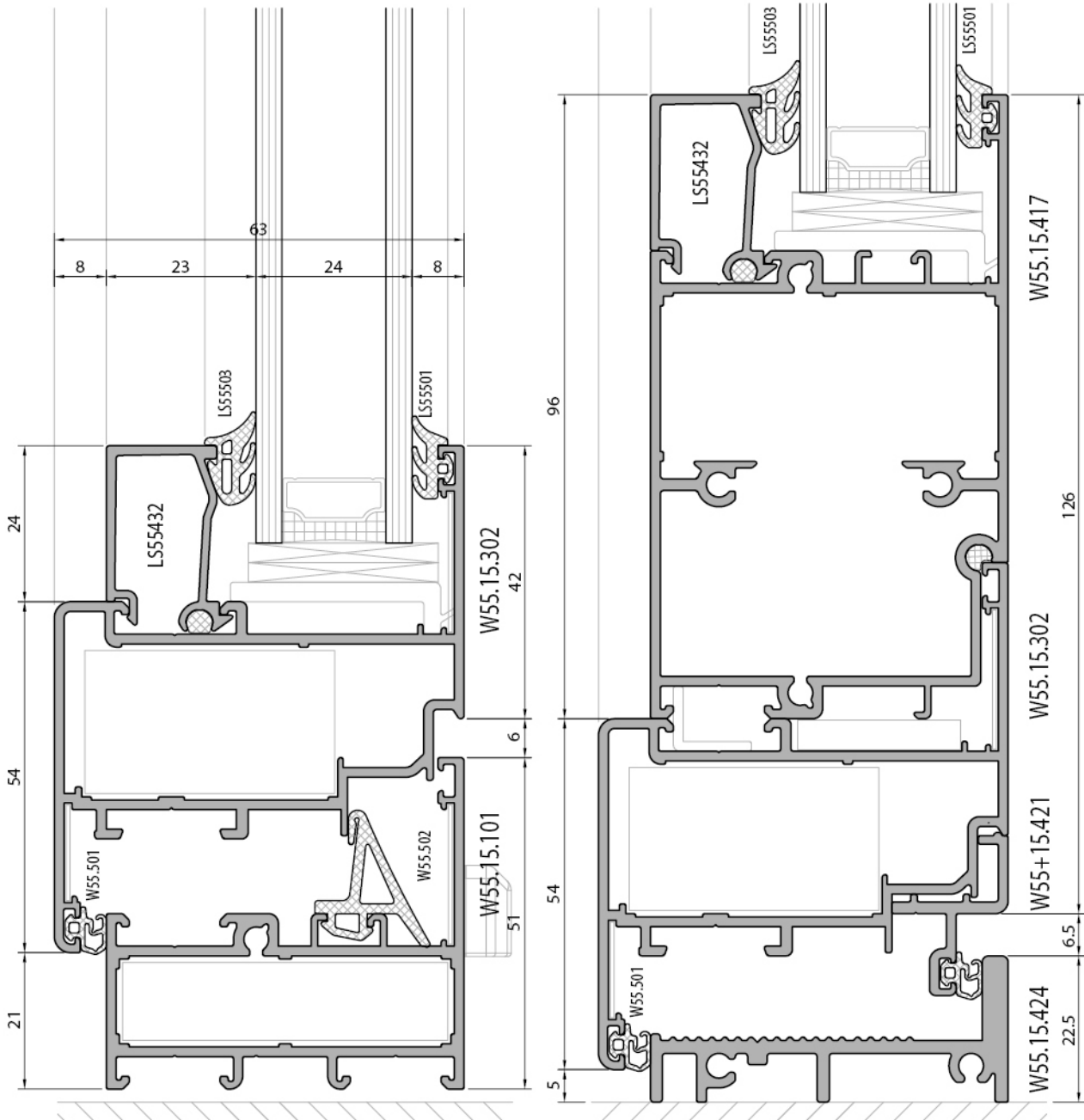

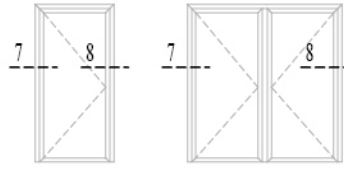

içe açılır kapı
inward opening door

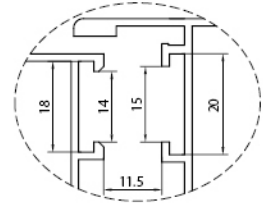

euro groove section 1

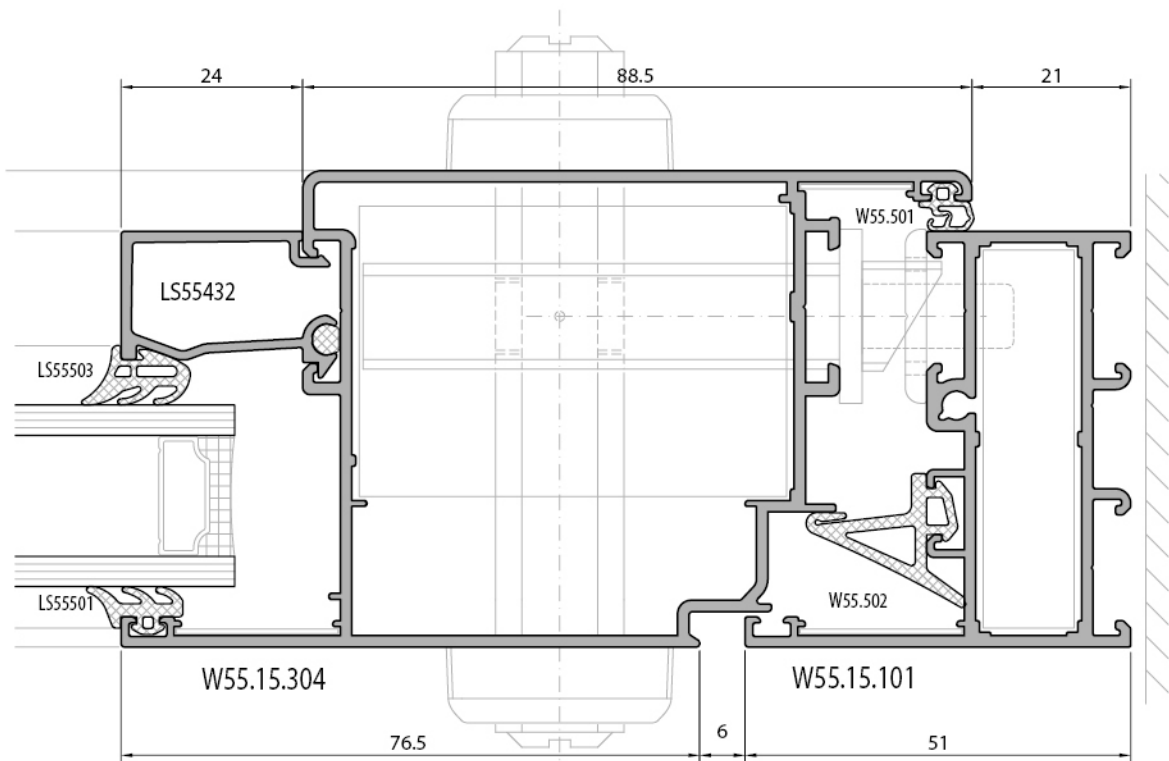
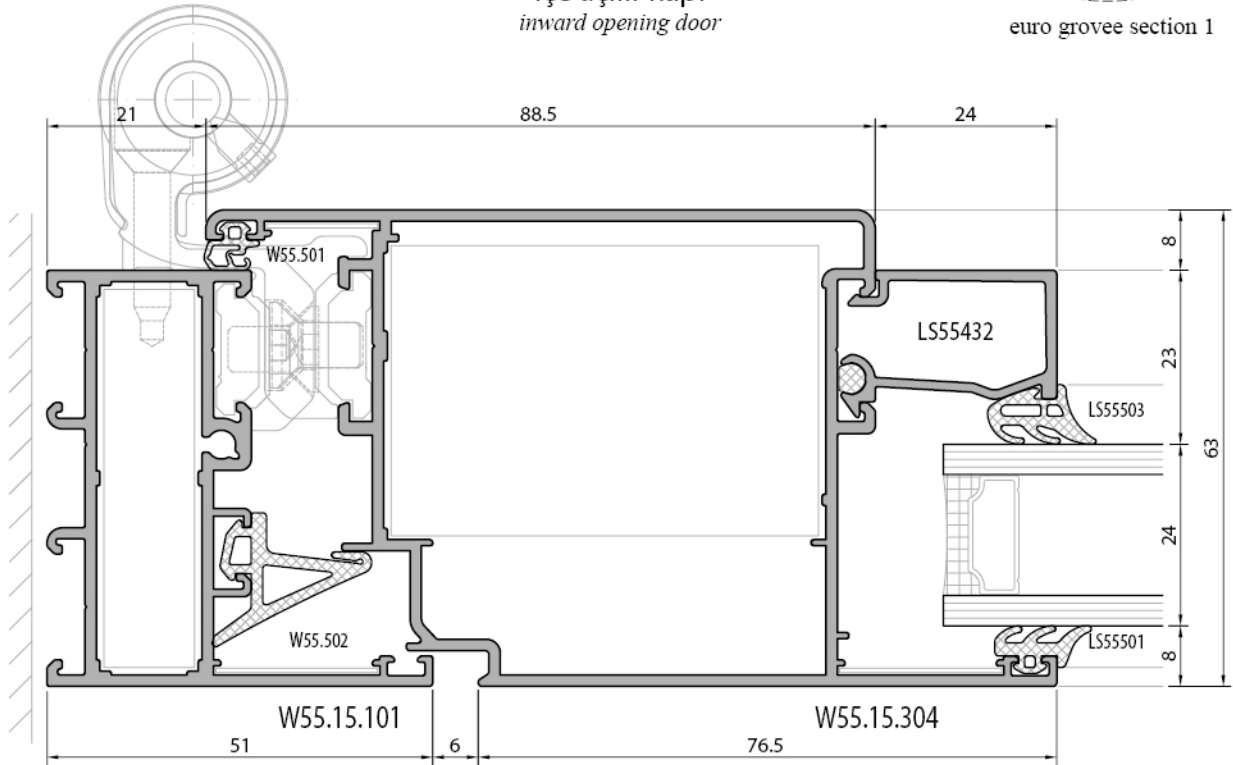

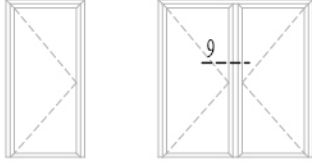

içe açılır kapı
inward opening door

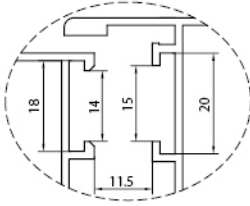

euro groove section 1

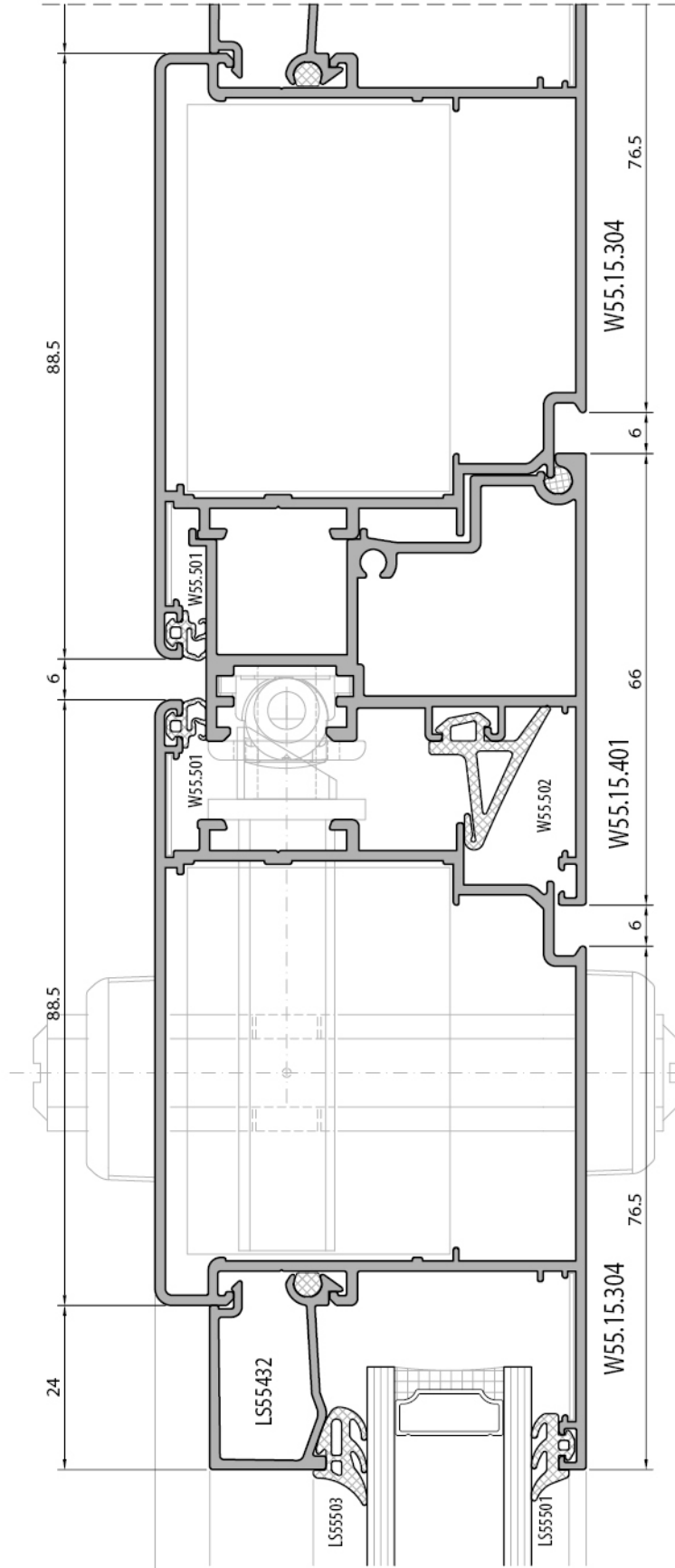
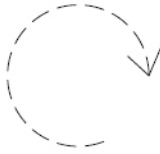

içe açılır kapı
inward opening door

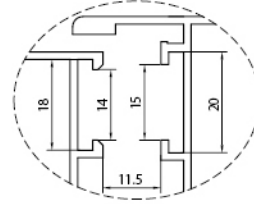
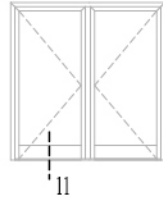

euro groove section 1

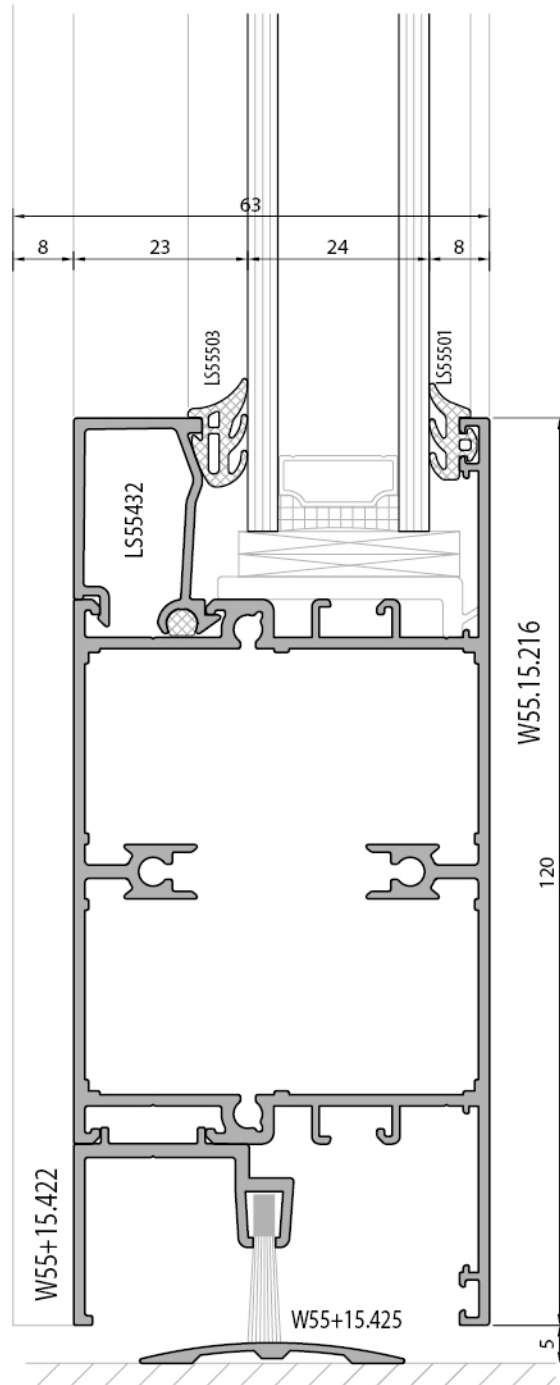

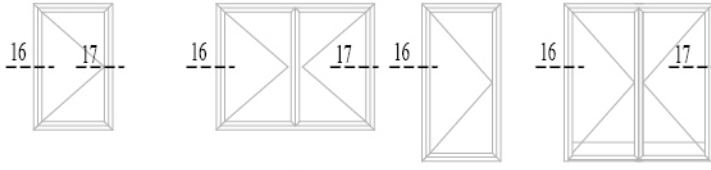

dışa açılır pencere
outward opening window

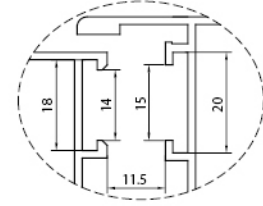

euro groove section 1

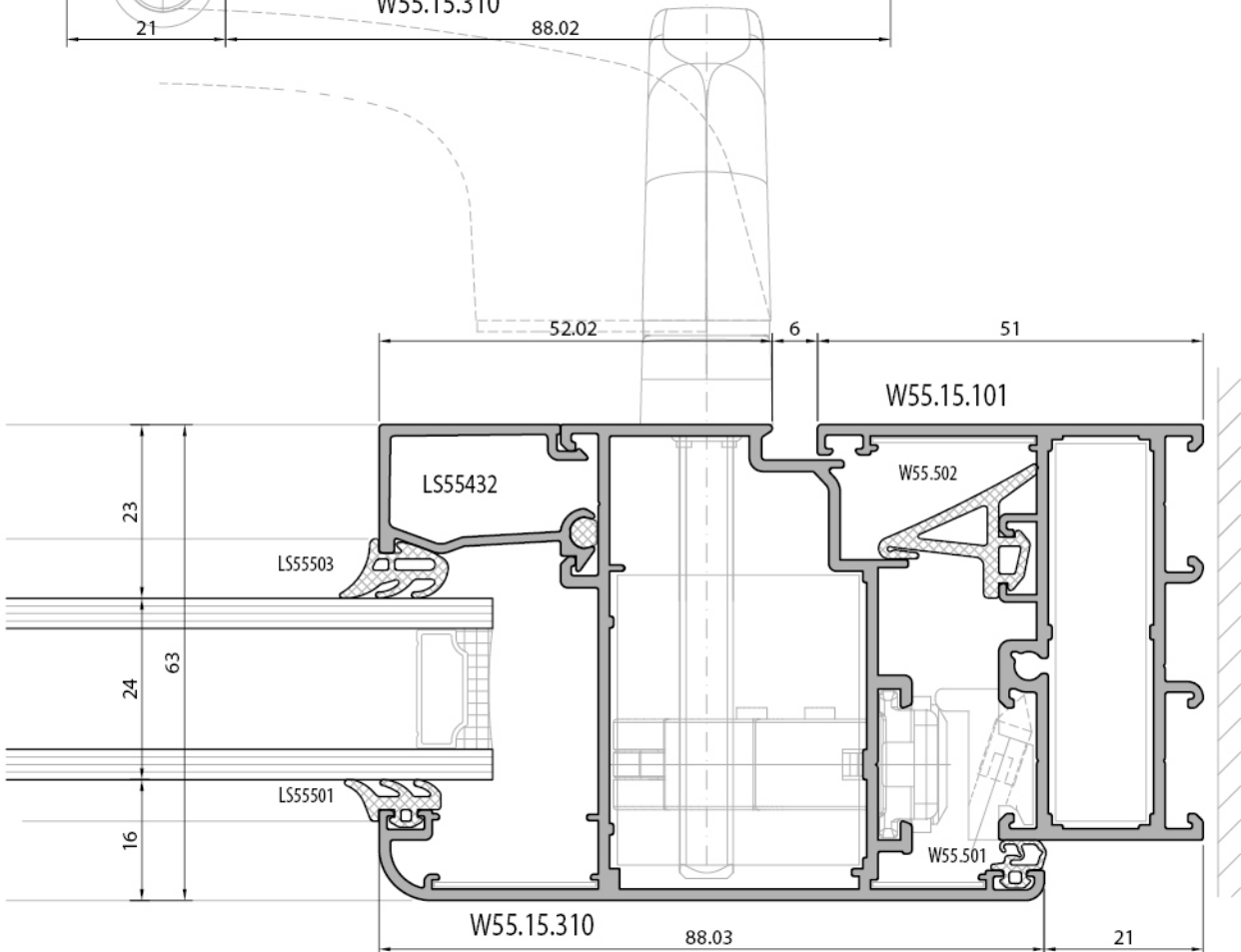
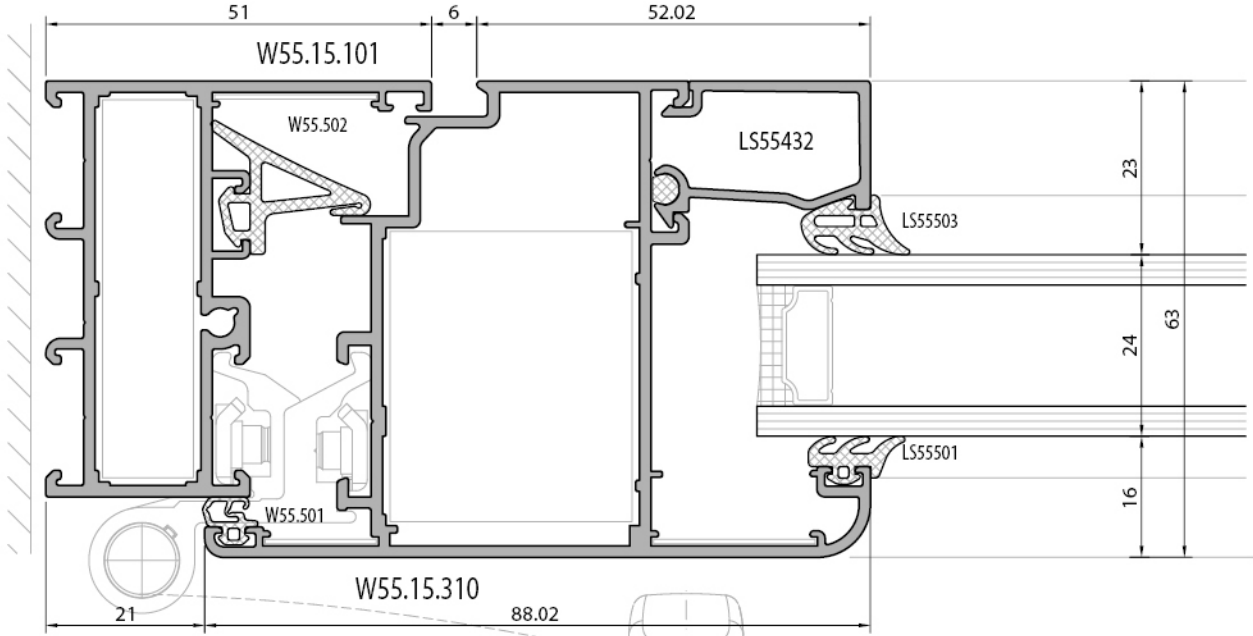

W55 PENCERE VE KAPI SİSTEMİ / WINDOW AND DOOR SYSTEM

SİSTEM DETAYLARI / SYSTEM DETAILS

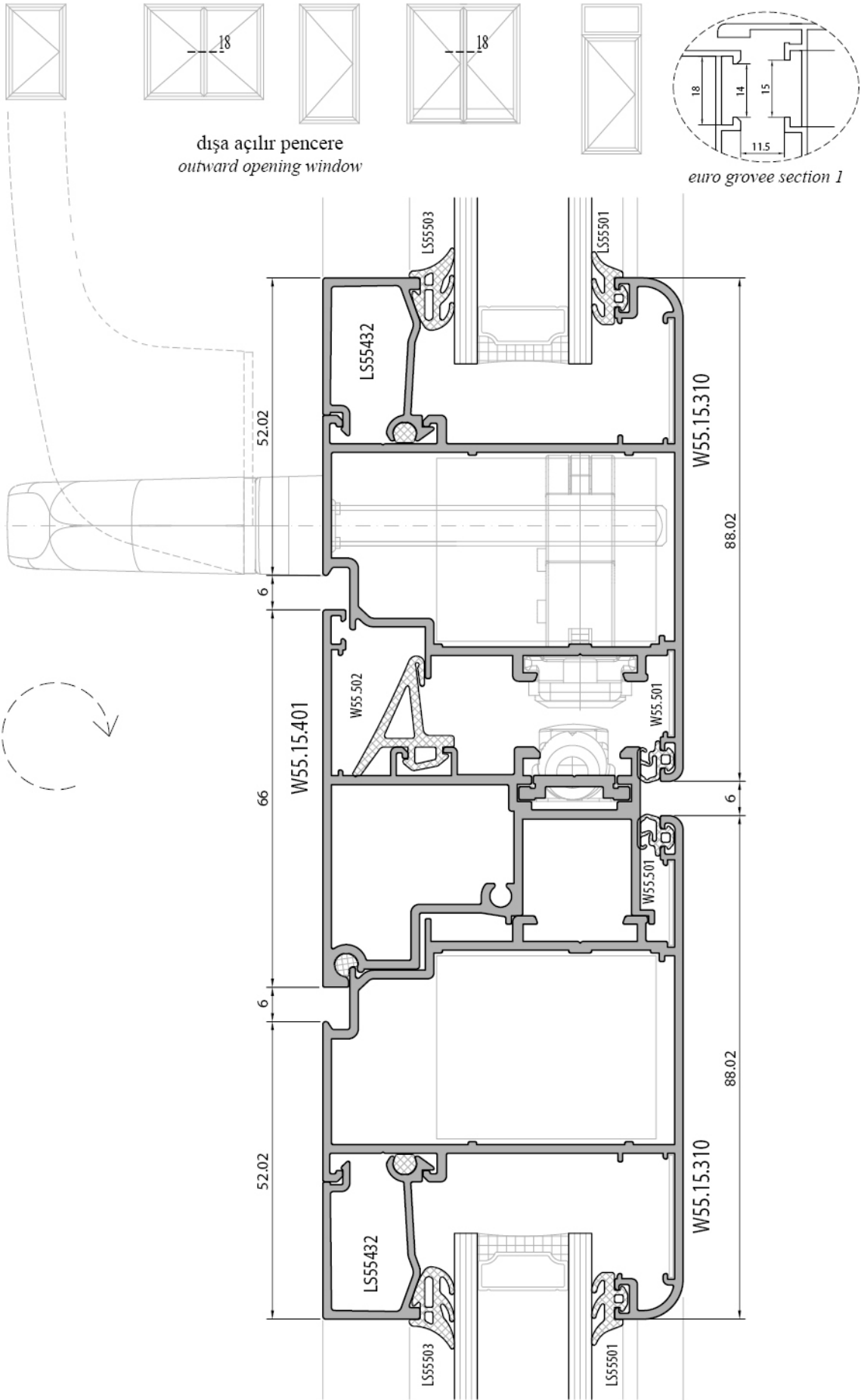

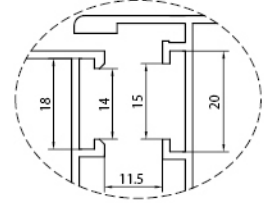
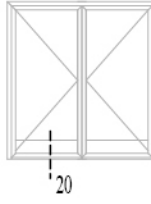
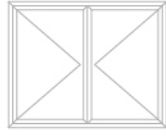
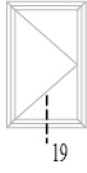

dışa açılır pencere
outward opening window

euro groove section 1

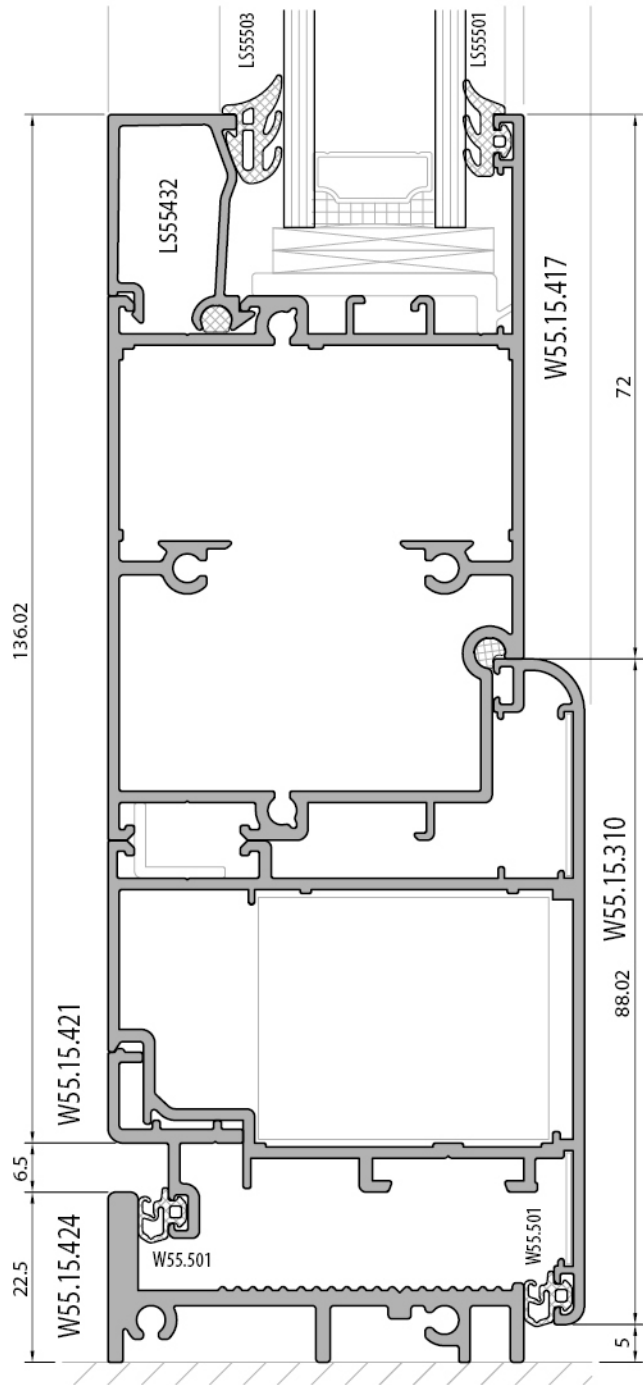
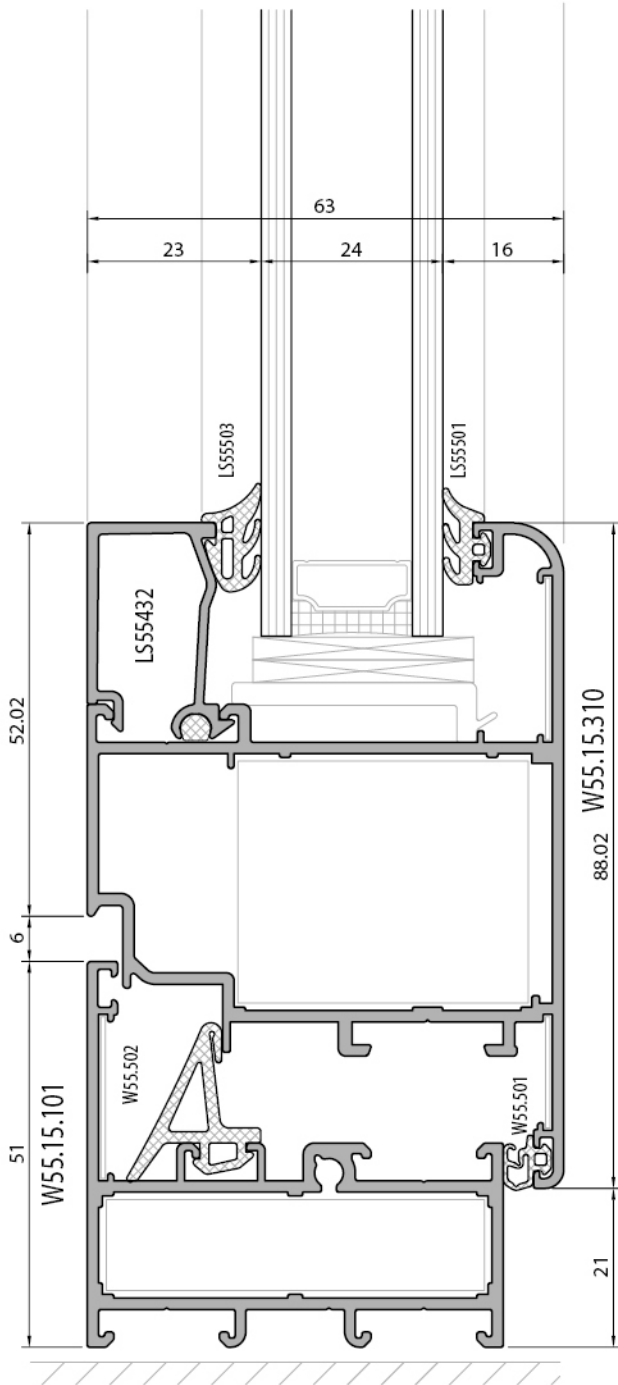

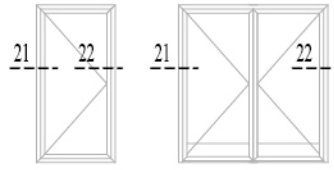

dışa açılır kapı
outward opening door

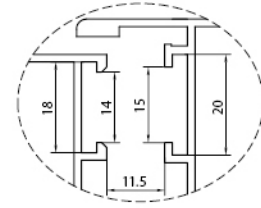

euro groove section 1

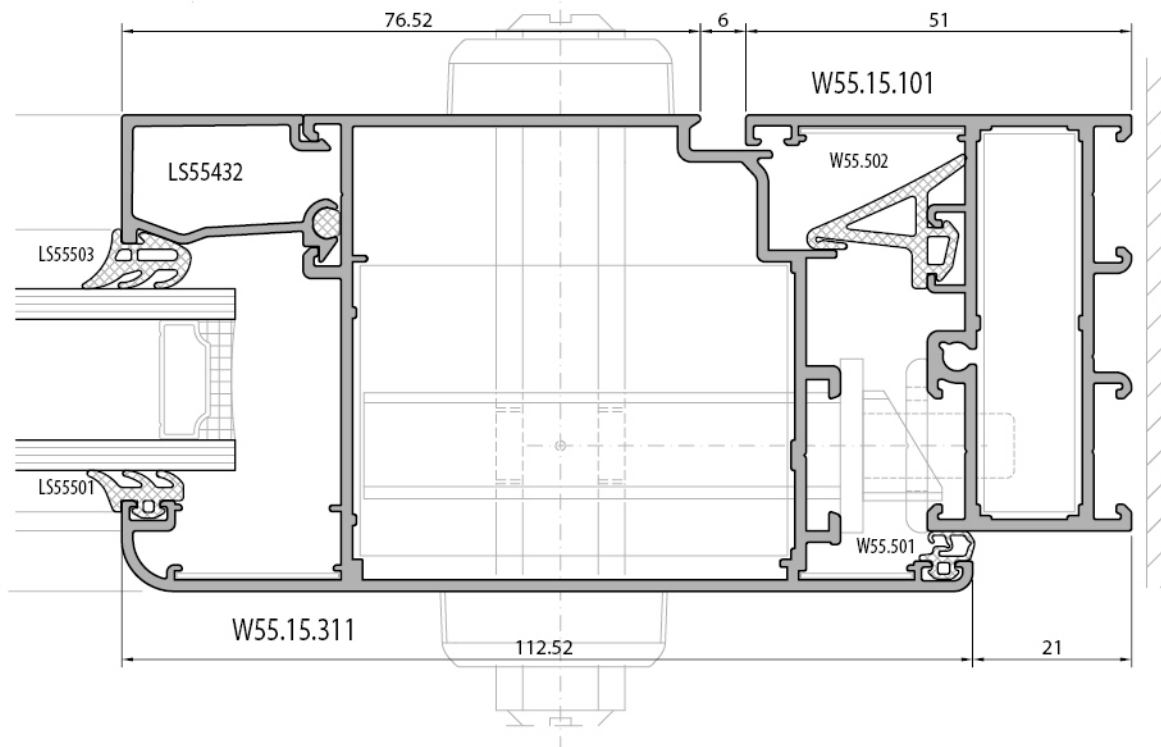
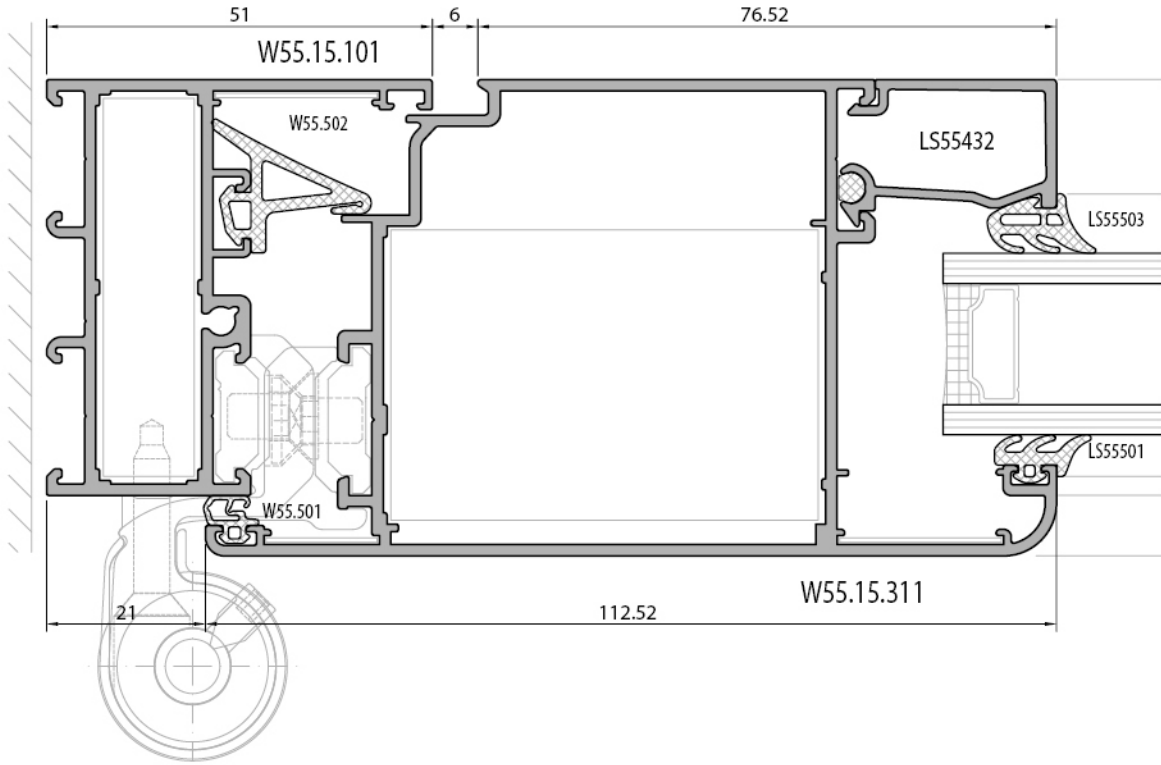



dışa açılır kapı
outward opening door

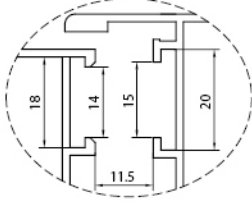

euro groove section 1

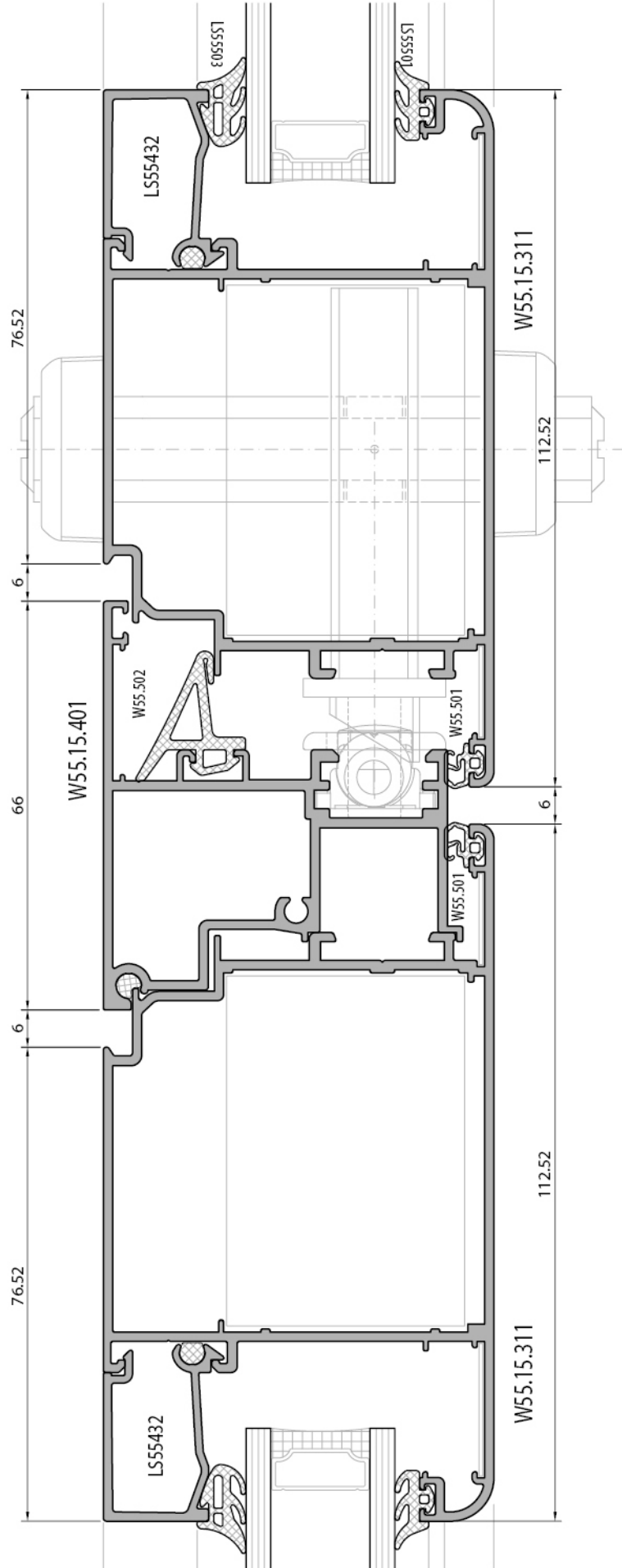
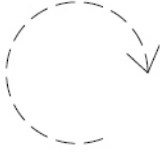

W55 PENCERE VE KAPI SİSTEMİ / WINDOW AND DOOR SYSTEM

SİSTEM DETAYLARI / SYSTEM DETAILS

dışa açılır kapı
outward opening door

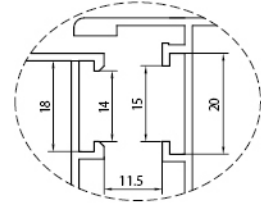

euro groove section 1

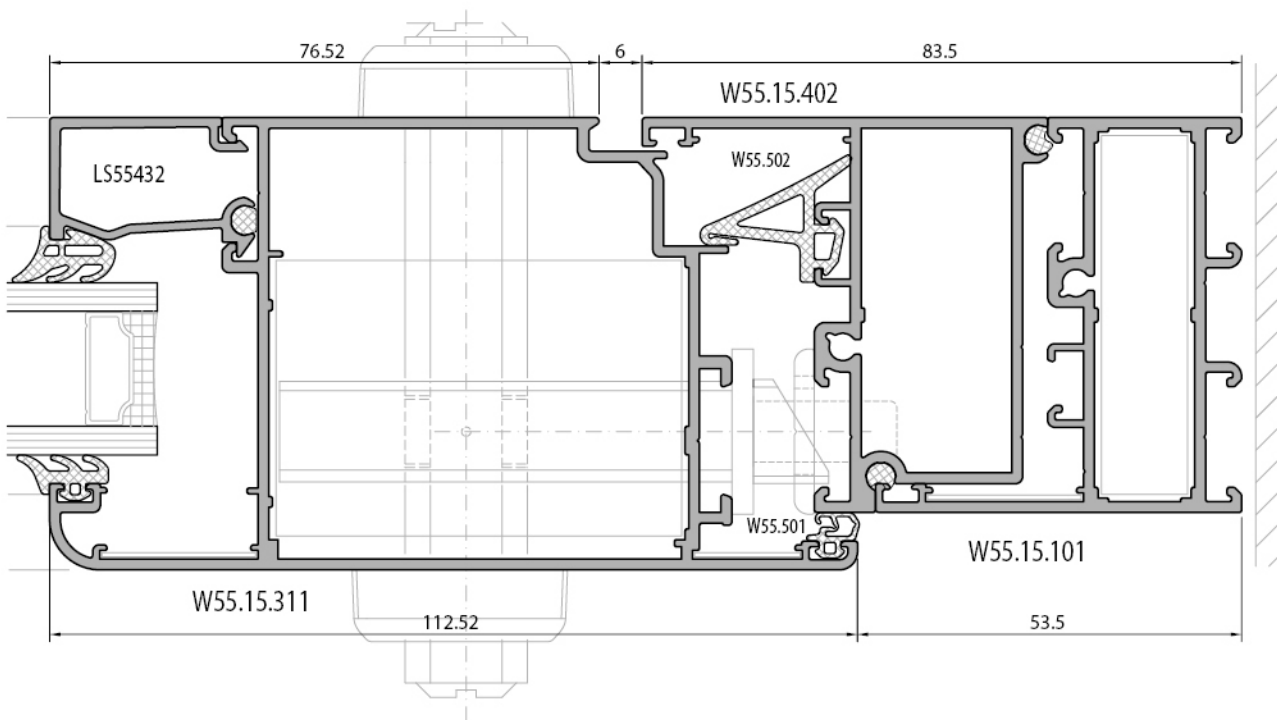
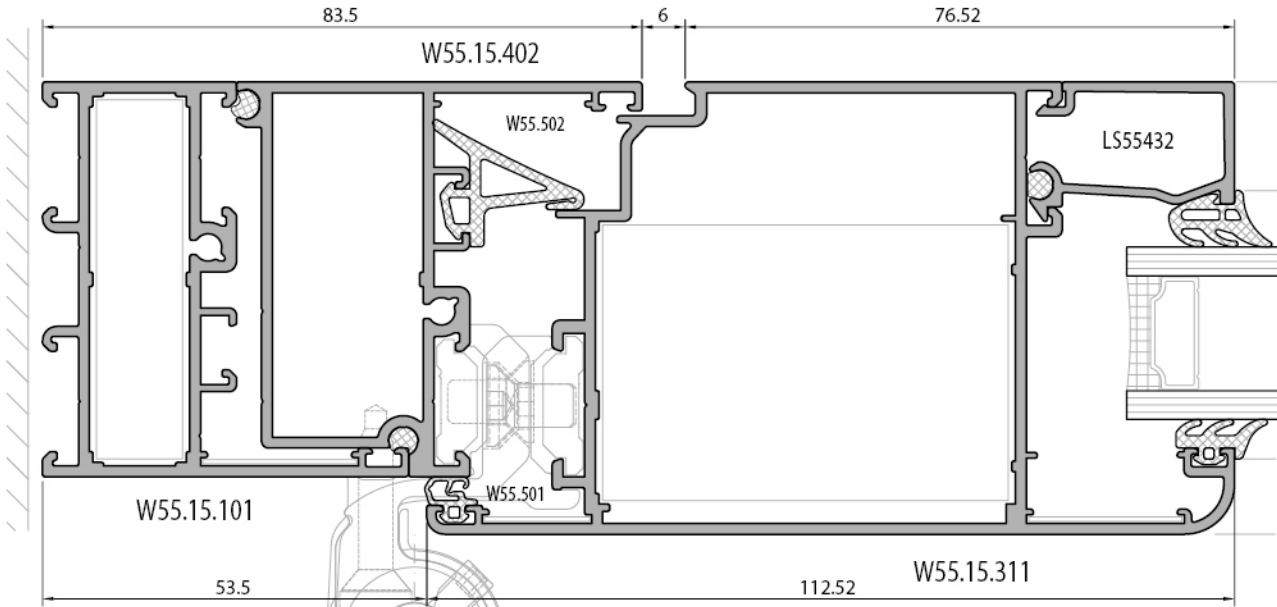



dışa açılır kapı
outward opening door

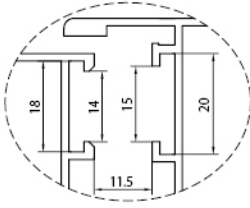

euro groove section 1

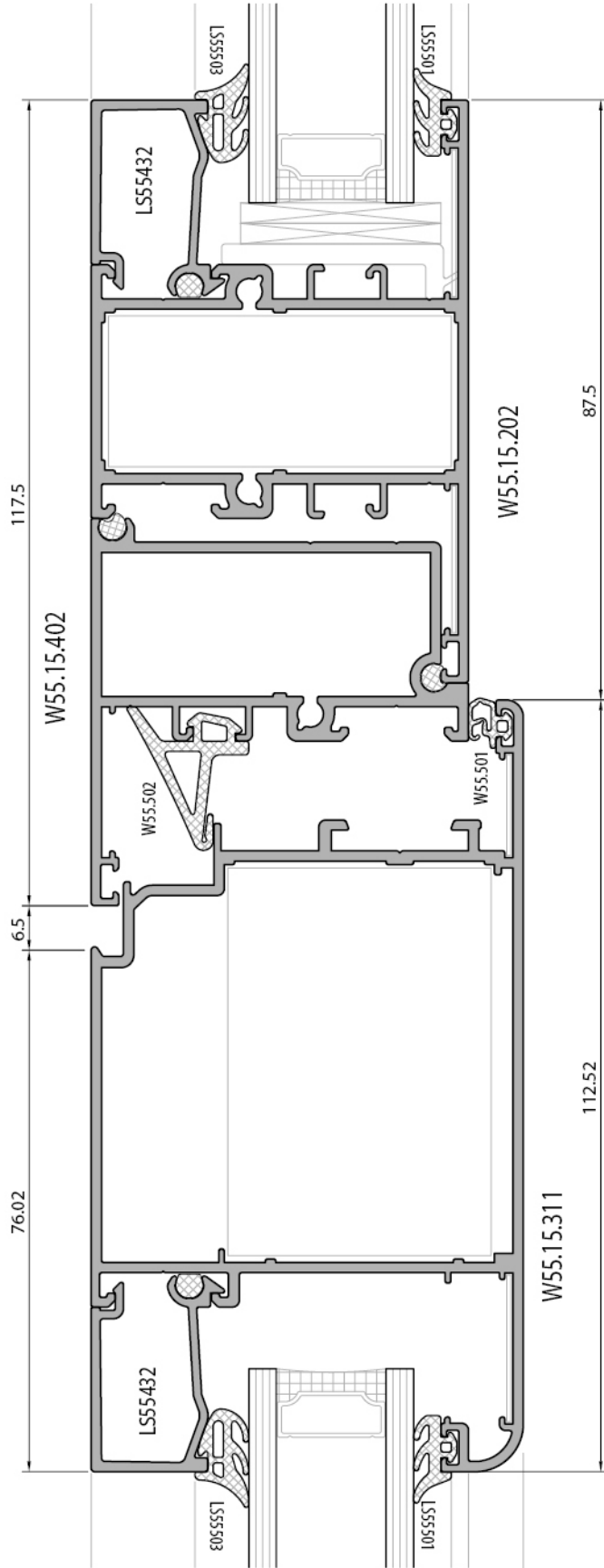

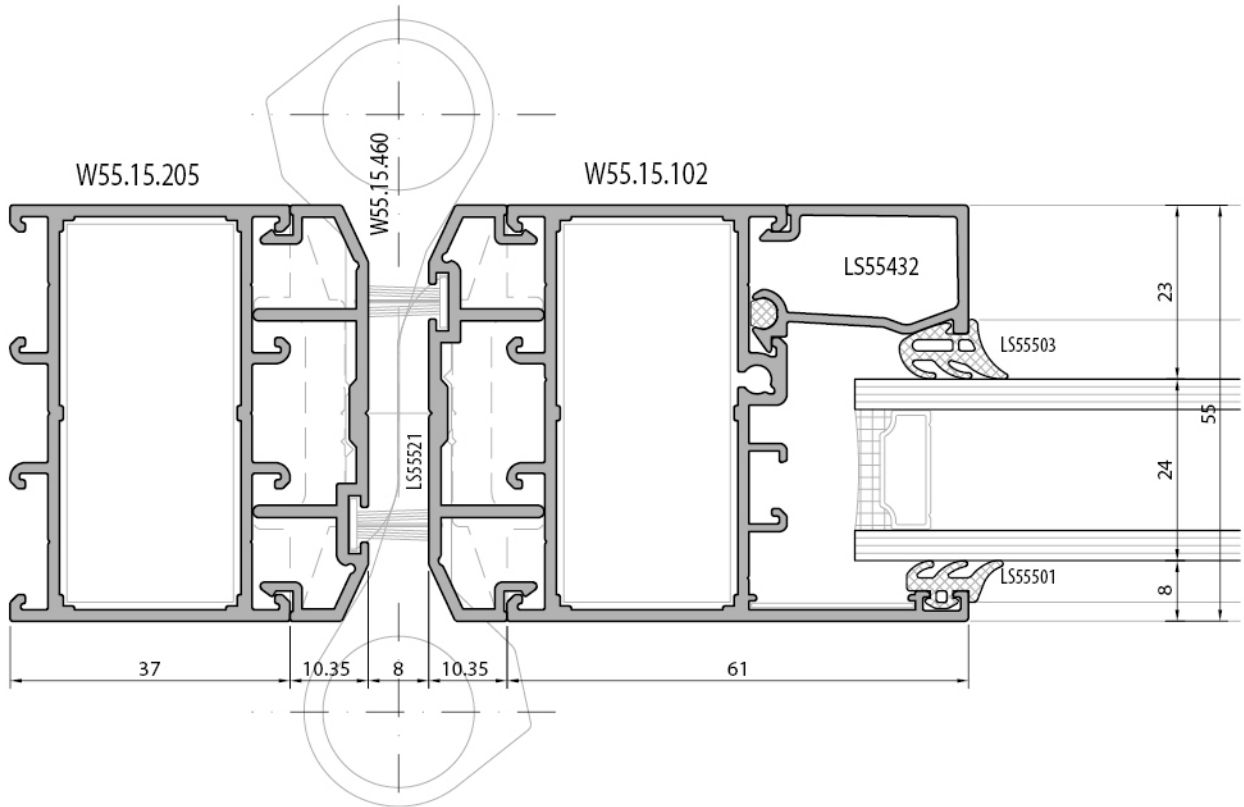
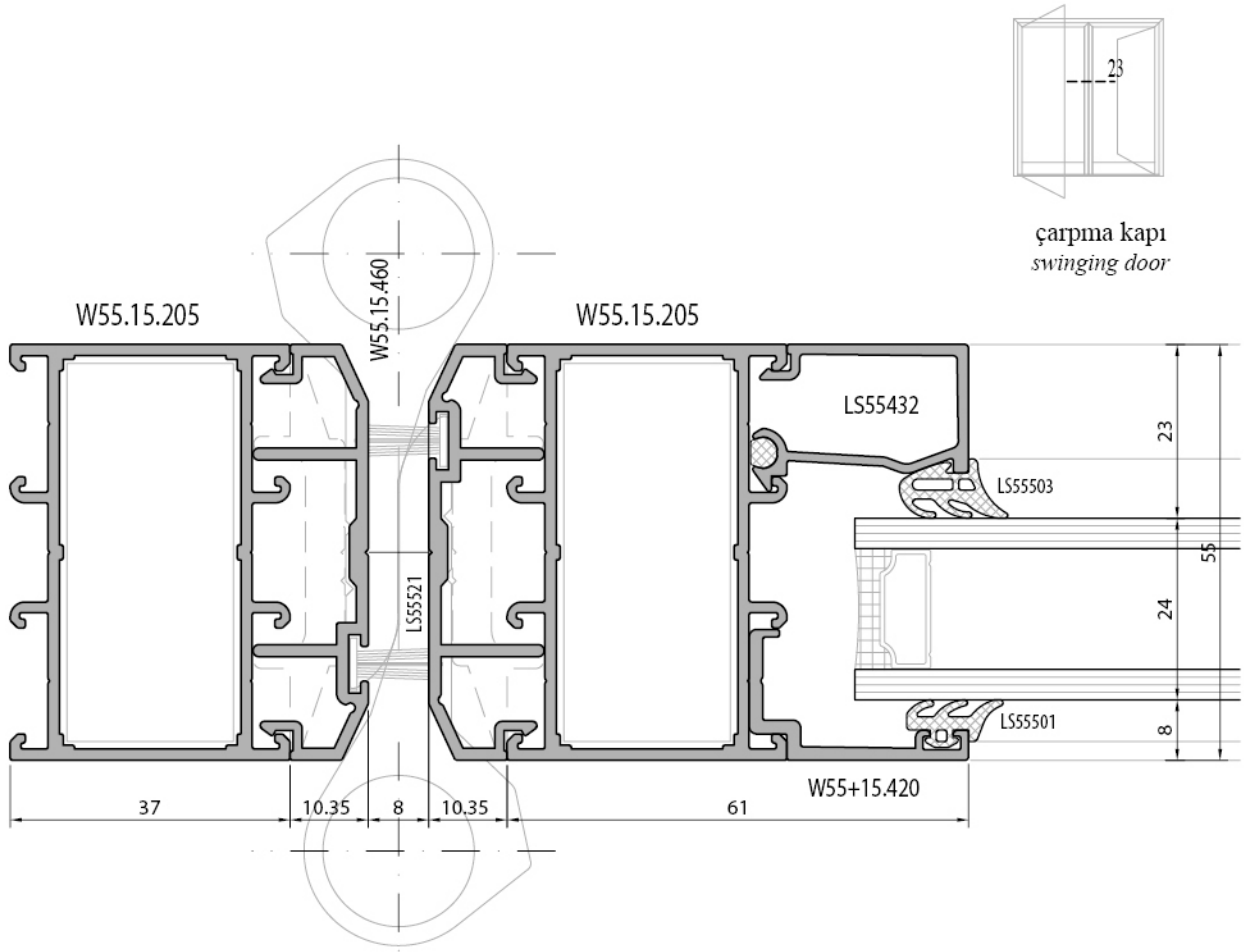

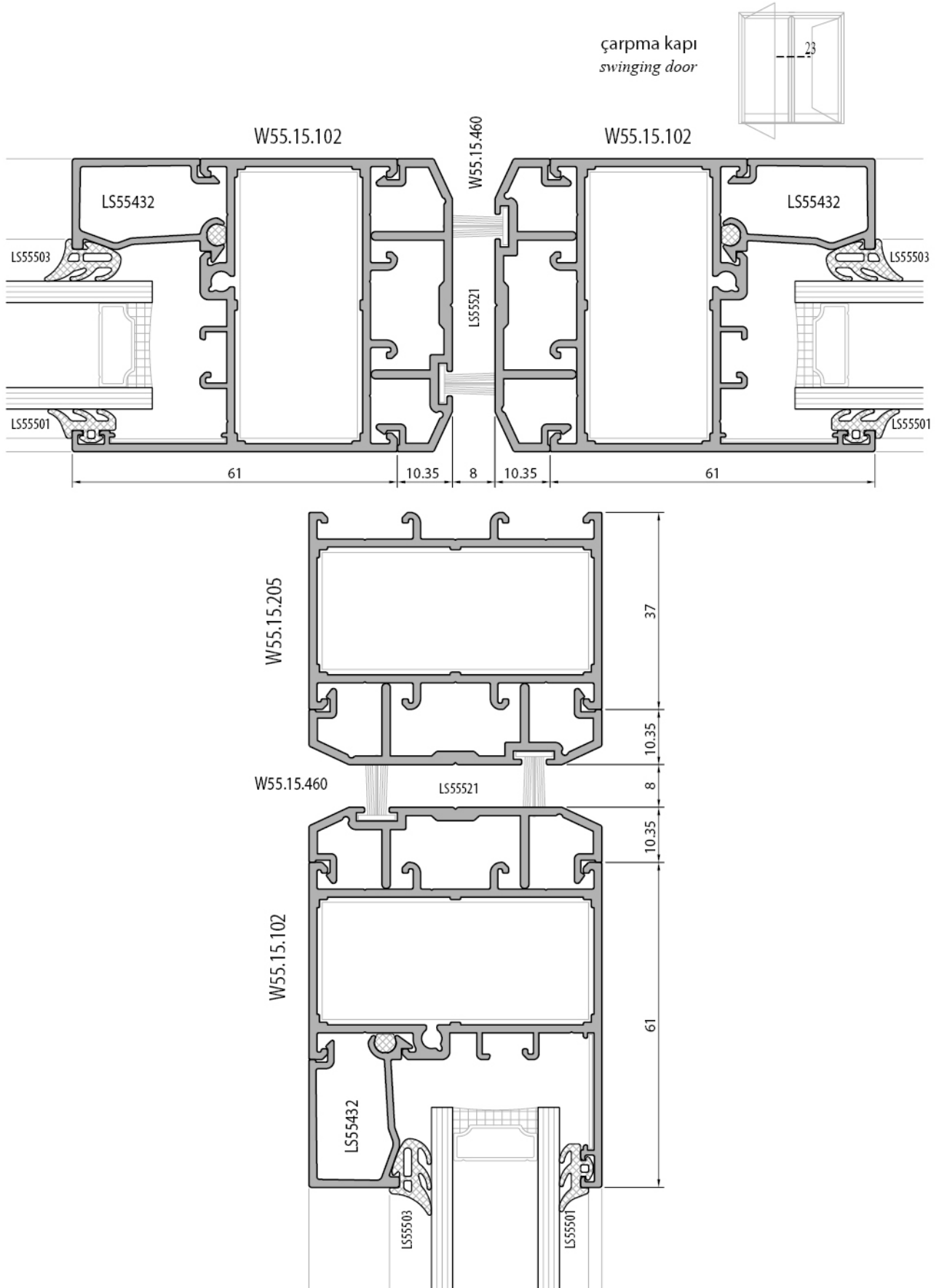

Normal / Vasistas / Çift açılım pencere
Normal / Tilt / Tilt & Turn window

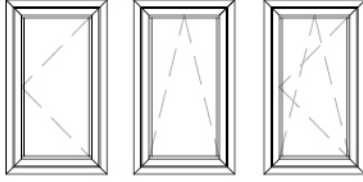

$$\begin{aligned} LK &= LKA+12 \\ HK &= HKA+12 \\ D &= A+48 \\ C &= B \\ CA &= A+30 \\ CB &= B+30 \end{aligned}$$

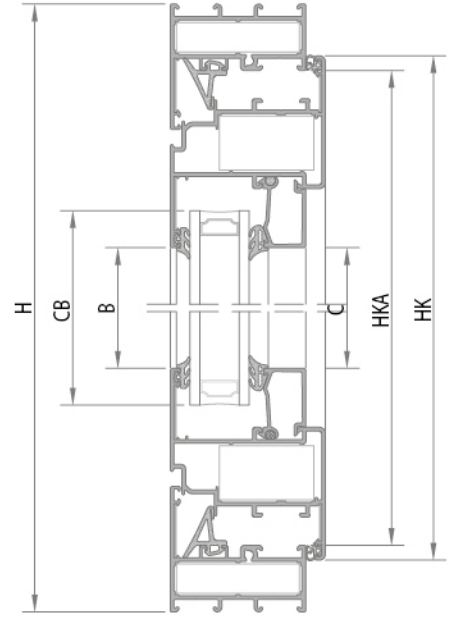
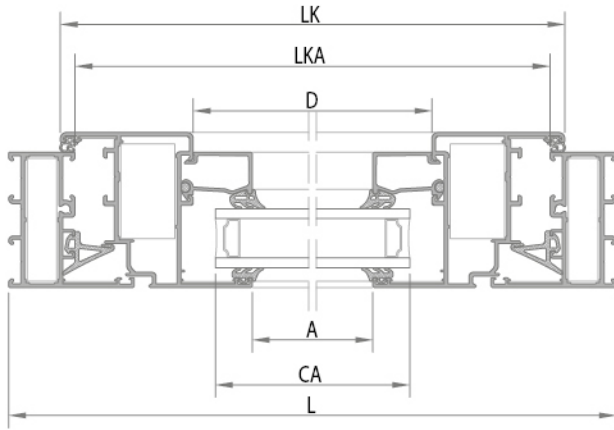

Normal / Çift açılım pencere
Normal / Tilt & Turn window

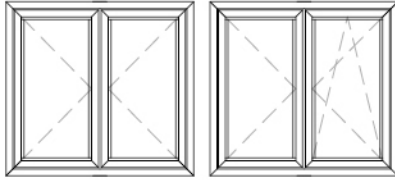

$$LK = (LKA/2)+3$$

$$HK = HKA+12$$

$$D = A+48$$

$$C = B$$

$$CA = A+30$$

$$CB = B+30$$

$$ADAPTÖR = HKA-64$$

- | | |
|-----|----------------------|
| L | doğrama eni |
| H | doğrama boyu |
| LK | kanat yatay ölçüsü |
| HK | kanat dikey ölçüsü |
| LKA | kasa yatay ara ölçü |
| HKA | kasa dikey ara ölçü |
| A | kanat yatay ara ölçü |
| B | kanat dikey ara ölçü |
| D | çita yatay ölçü |
| C | çita dikey ölçü |
| CA | cam yatay ölçüsü |
| CB | cam dikey ölçüsü |

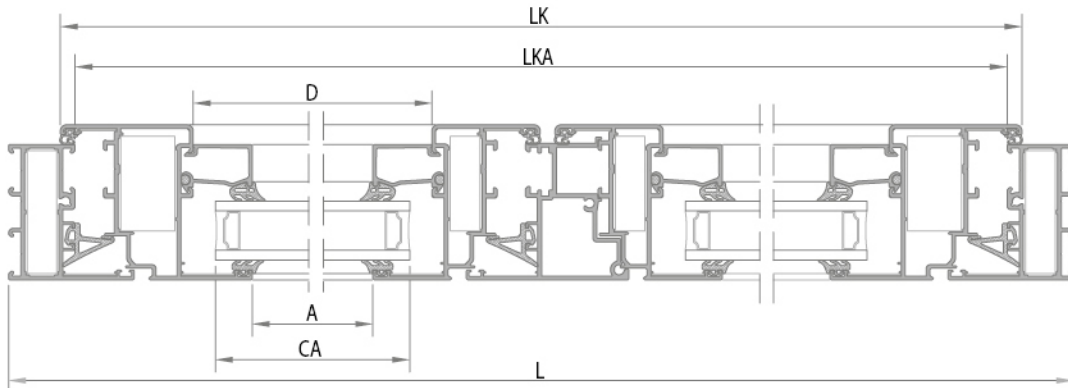
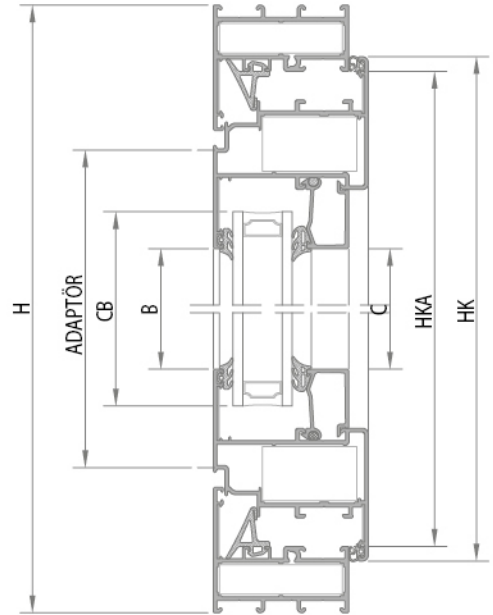

İçe açılır kapı
inward opening door

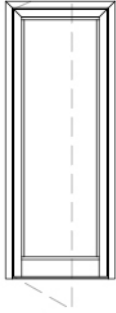

- L doğrama eni
H doğrama boyu
LK kanat yatay ölçüsü
HK kanat düşey ölçüsü
LKA kasa yatay ara ölçü
HKA kasa düşey ara ölçü
A kanat yatay ara ölçü
B kanat düşey ara ölçü
D çita yatay ölçü
C çita düşey ölçü
CA cam yatay ölçüsü
CB cam düşey ölçüsü

$$LK = LKA + 12$$

$$HK1 = HKA1 + 1$$

$$D = A + 48$$

$$C = B$$

$$CA = A + 30$$

$$CB = B + 30$$

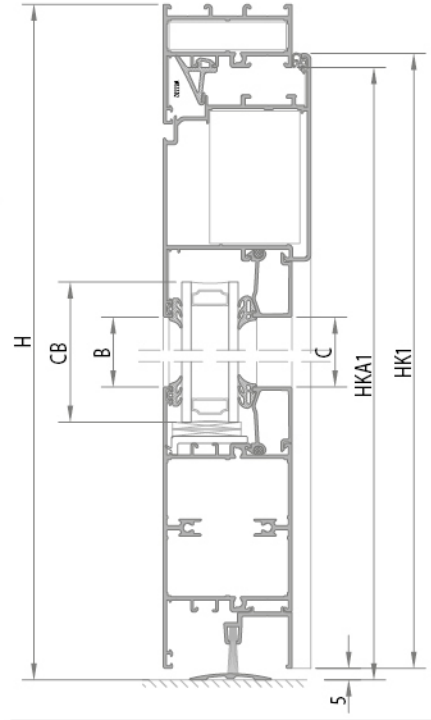
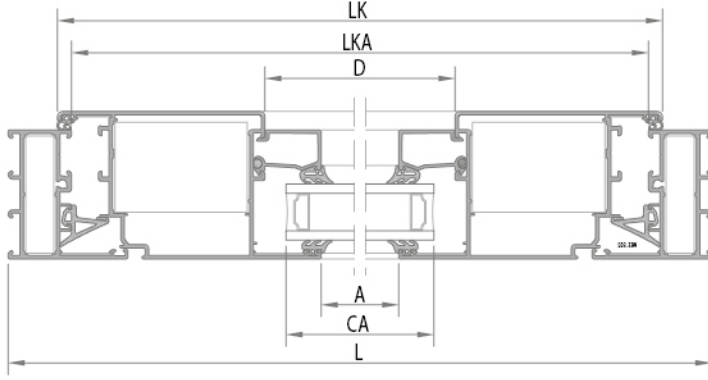

Çift kanat içe açılır kapı
Double sash inward opening door

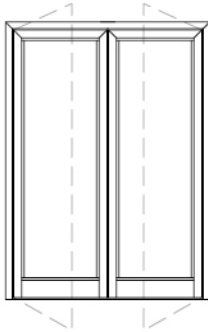

$$LK = (LKA/2) + 3$$

$$HK1 = HKA1 + 1$$

$$D = A + 48$$

$$C = B$$

$$CA = A + 30$$

$$CB = B + 30$$

$$ADAPTÖR = HKA2 - 62$$

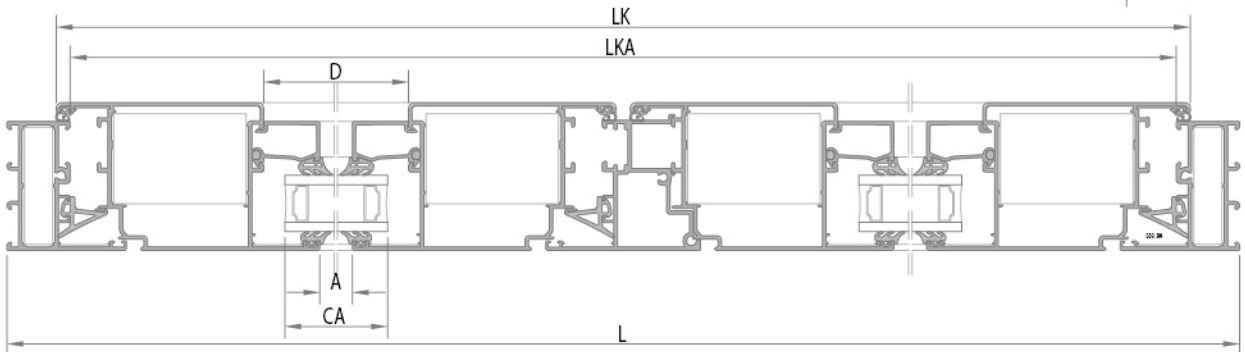
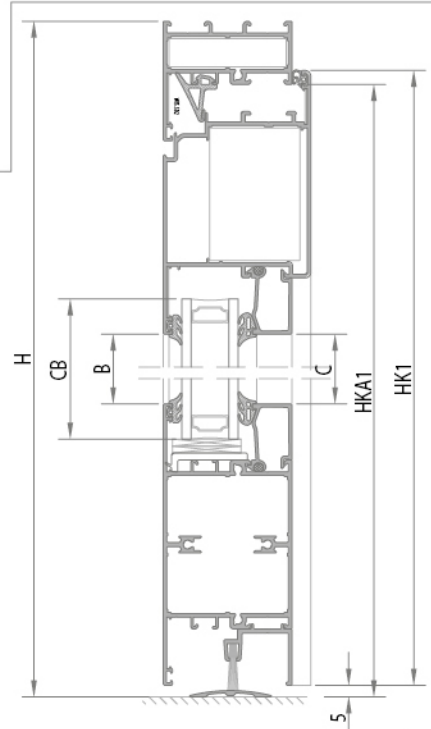

W55 PENCERE VE KAPI SİSTEMİ / WINDOW AND DOOR SYSTEM

KESİM - MONTAJ ÇİZİMLERİ / CUTTING ASSEMBLY DRAWINGS

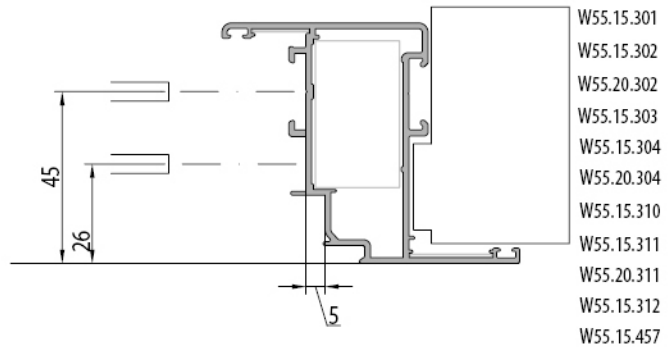
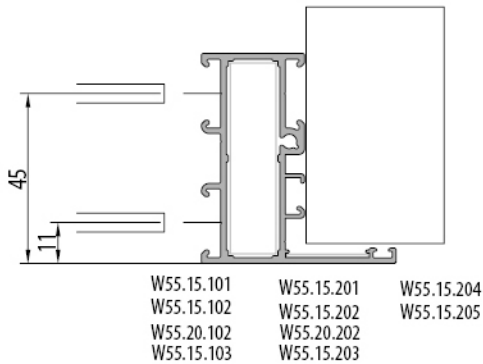
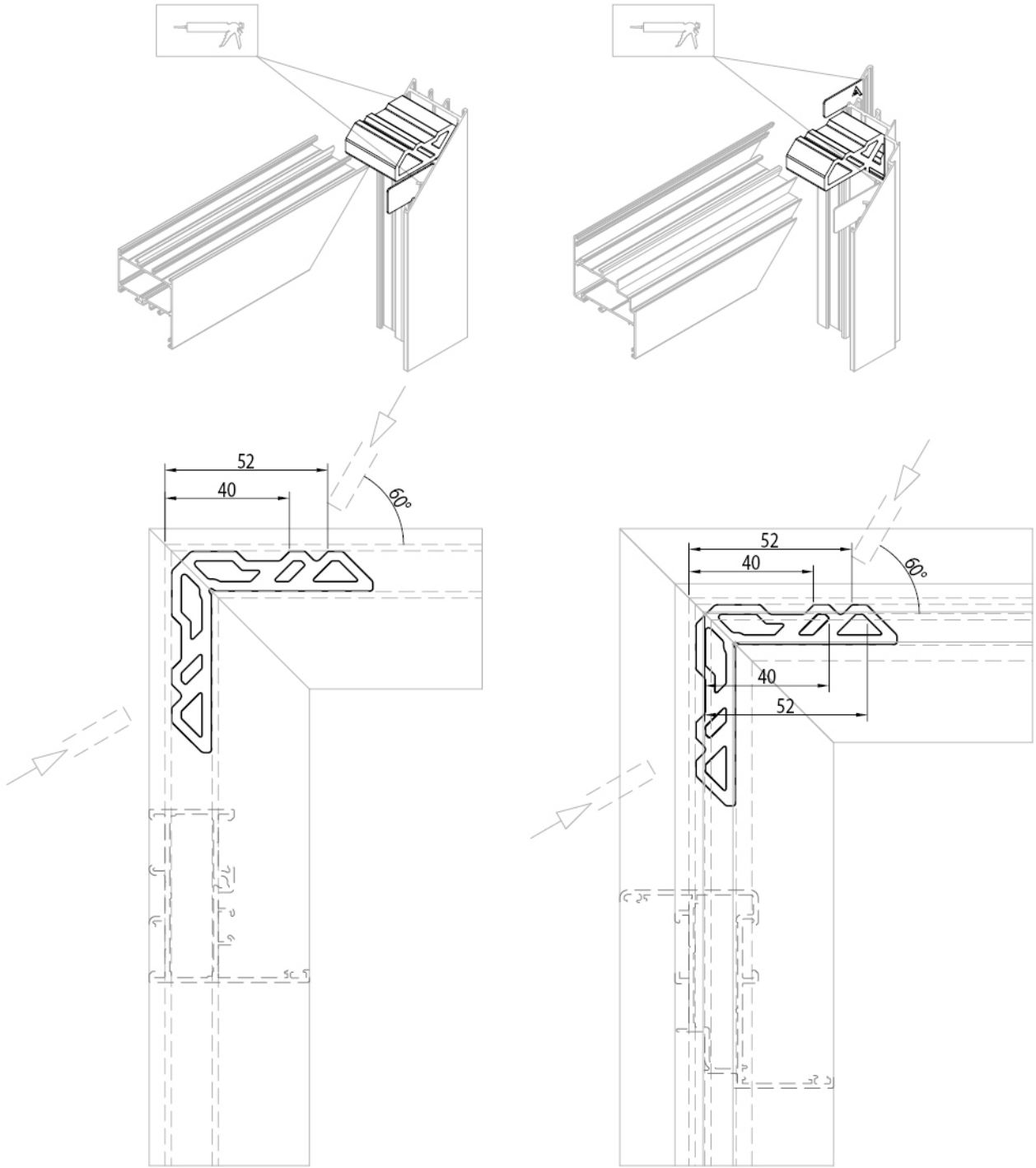

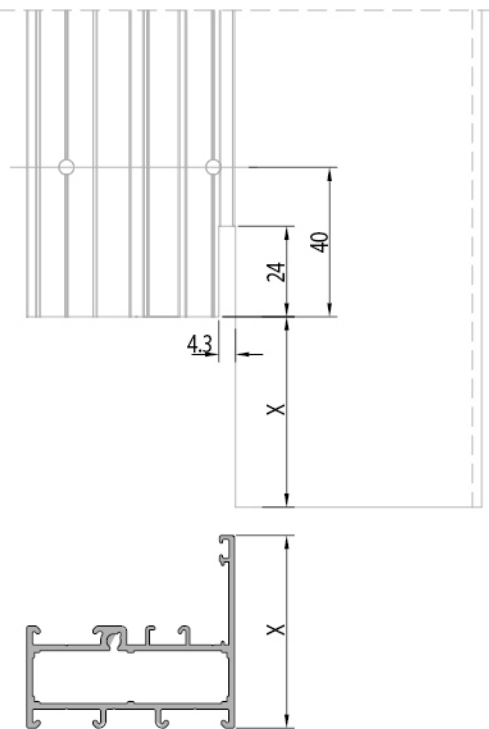
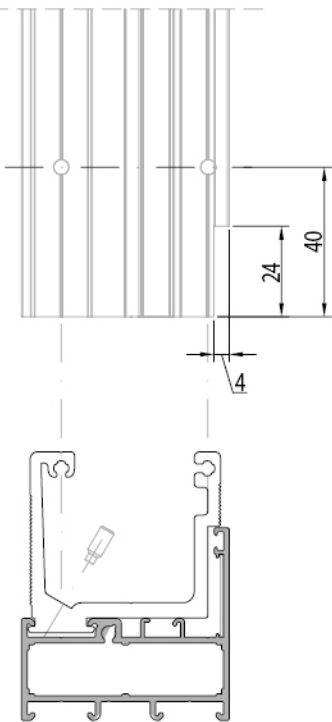
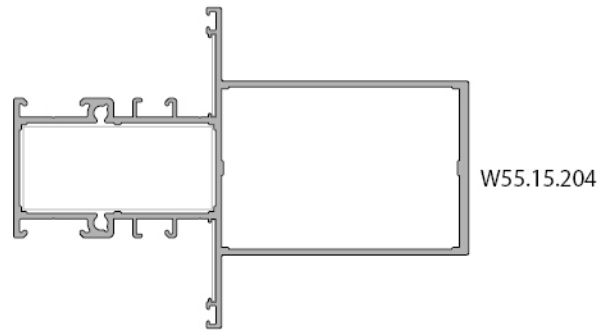
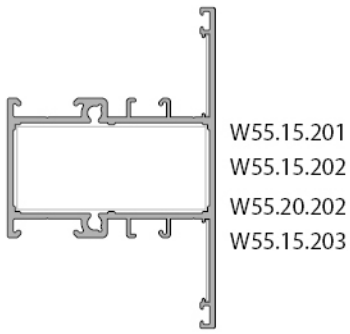
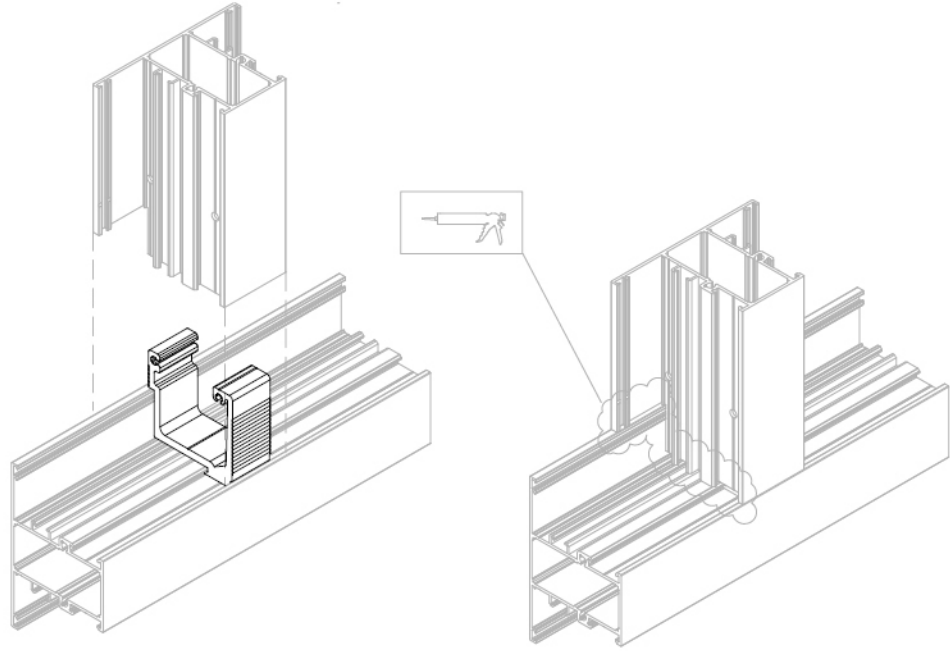

W55 PENCERE VE KAPI SİSTEMİ / WINDOW AND DOOR SYSTEM

KESİM - MONTAJ ÇİZİMLERİ / CUTTING ASSEMBLY DRAWINGS

